

# THE CASE FOR TALL WOOD BUILDINGS

**SECOND EDITION**

MGA | MICHAEL GREEN ARCHITECTURE

How Mass Timber Offers a Safe,  
Economical, and Environmental Friendly  
Alternative for Tall Building Structures

TALL  
WOOD

TALL

WOOD

# THE CASE FOR TALL WOOD BUILDINGS

**SECOND EDITION** PRODUCED BY  
MGA | MICHAEL GREEN ARCHITECTURE

How Mass Timber Offers a Safe,  
Economical, and Environmental Friendly  
Alternative for Tall Building Structures



<b>INTRODUCTION</b>	I
<b>EXECUTIVE SUMMARY</b>	II
<b>PART 1 : RESEARCH PHASE</b>	
1.1 Climate Change, Population Growth and our Forests	22
1.2 Context for Tall Wood	24
1.3 World-wide Reference Projects and Studies	26
1.4 Canadian Reference Projects and Studies	30
1.5 Material Research and System Research	32
1.6 Evolution of the Building Code	38
<b>PART 2 : IDENTIFYING CHALLENGES</b>	
2.1 Preliminary Survey of Industry Preconceptions	50
<b>PART 3 : CASE STUDY DESIGN</b>	
3.1 Prototype and Market Conditions	56
3.2 FFTT Solution	57
3.3 Concrete Benchmark	58
3.4 Proposed Tower Solutions - Applied and Theoretical Plans	62
3.5 Architectural Application of an Idea	76
3.6 Structural Intent	84
3.7 Fire Performance	124
3.8 Sound Performance	138
3.9 Building Enclosure	140
3.10 Systems Integration	148
3.11 Typical Details	154
3.12 Cost Analysis	188
3.13 Schedule Analysis	191
3.14 Market Factors	192
3.15 Constructability	194
<b>PART 4 : INDUSTRY INTERVIEWS</b>	
4.1 Industry Representatives	204
<b>PART 5 : NEXT STEPS</b>	
5.1 Recommended Studies	214
<b>PART 6 : REFERENCE DOCUMENTS</b>	
Appendix A: Structural Details	223
Appendix B: Cost Analysis Documentation	253
Glossary	261
Bibliography	265

## Introduction

We are in a unique moment in architectural and building engineering history when shifting world needs has asked us to question some of the fundamentals of how we have built for the last century and how we will build in the next.

**“I’d put my money on solar energy...I hope we don’t have to wait till oil and coal run out before we tackle that.” Thomas Edison, *In conversation with Henry Ford and Harvey Firestone March 1931***

Wood is the most significant building material we use today that is grown by the sun. When harvested responsibly wood is arguably one of the best tools architects and engineers have in reducing emissions and storing carbon in our buildings. The Case for Tall Wood Buildings expands the discussion of where we will see wood and specifically Mass Timber in the future of the world’s skylines. As we pursue the green energy solutions that Thomas Edison spoke of over 80 years ago we must consider that we are surrounded by a building material that is manufactured by nature; a material that is renewable, durable and strong.

This report introduces a major opportunity for systemic change in the building industry. For the last century, there has been no reason to challenge steel and concrete as the essential structural materials of large buildings. Climate Change now demands that we do. The work of thousands of scientists with the United Nations Intergovernmental Panel on Climate Change (IPCC) has defined one of the most significant challenges of our time. How we address Climate Change in buildings is a cornerstone in how the world will tackle the need to reduce emissions of green house gases and indeed find ways to store those same gases that are significantly impacting the health of our planet. Just as the automobile industry, energy sector, and most other industries will see innovations that challenge the conventions of the way we will live in this century, the building industry must seek innovation in the fundamental materials that we choose to build with. In a rapidly urbanizing world with an enormous demand to house and shelter billions of people in the upcoming decades we must find solutions for our urban environments that have a lighter climate impact than today’s incumbent major structural materials. This report is a major step in that direction. Indeed it introduces the first significant challenger to steel and concrete in tall buildings since their adoption more than a century ago.

The work in this report reflects several years of momentum, effort, and conviction of many people interested in the issues of climate change, architecture, wood design and innovation. The story the report tells is one of optimism of a progressive new way of building safe and environmentally-friendly large buildings.

The report challenges conventions. It attempts to address pre-conceptions. We have tried to communicate and educate with the full story of why tall and large wood building structures are important to understand at both a broad principal and detailed level. This study is the beginning of a path to realizing built projects. More engineering, research, and testing will be required to expand on the ideas we discuss. We hope that architects and engineers will join us in pursuing this discussion and in developing increasingly broader approaches to tall wood buildings. We also hope that the ideas within the study will gain momentum within the larger building industry and be the precursor to a revolution in the way we build mid-rise and tall buildings around the globe.

**Michael Green** ARCHITECT AIBC, FRAIC, AIA

## **Acknowledgements**

We would like to specifically thank a number of people and organizations that have helped our team learn and share these important ideas. Our special thanks to Mary Tracey and Oscar Faoro of WoodWORKS! BC and Etienne Lalonde of the Canadian Wood Council who have helped organize our effort with this study. Thank you also to the many people we have interviewed from developers, marketing groups and contractors to building authorities and fire chiefs. Thank you to Andrew Waugh of Waugh Thistleton Architects in London, England for his determination to lead by example and show the world what is possible in tall wood in his 9 storey Stadhaus project. Thanks to FPIInnovations, Natural Resource Canada, BC Wood, WoodWORKS! BC and the Canadian Wood Council for their research and dedication to the increased and responsible use of wood. Thanks also to those that have shown considerable interest in helping spread this discussion to the world including TEDxVancouver, the Canadian and US WoodWORKS! programs, the Canadian Green Building Council, the Australian Green Building Council, Forestry and Wood Products Australia, The UN Food and Agriculture Organization and the Province of British Columbia. Most of all thank you to the Canadian Wood Council (CWC), the Wood Enterprise Coalition (WEC) and Forestry Innovation Investment (FII) who have opened the door to a breadth of important innovation in wood.

### **Equilibrium's Special Acknowledgements**

We would also like to thank Dr. Mahmoud Rezai, PhD, StructEng of EQ Engineering for his work on the typical concrete base building details as well as for his concept review comments.

Numerous other colleges have also kindly provided comments on the overall structural concept presented in this study. In particular, we would like to thank Dr. Leander Bathon, PhD, Ing from the University of Wiesbaded, Germany, for his comments on the concept of the proposed lateral load resisting system and the use of the HSK system in particular for hold-down connections. We would also like to thank Dr. Andre Filiatrault, PhD, Eng, chair of Multi-Disciplinary Center for Earthquake Engineering (MCEER) and professor at Buffalo University, for taking the time to discuss the lateral load resisting system concept with us.

### **Report Team Acknowledgements**

The decision to 'open-design' the FFTT solution is very important. The aspiration to move the world towards more sustainable structural solutions is the fundamental motivator of all involved in preparing this report. This is about sharing good ideas and choosing not to profit from them. I am very proud of the project team that has dedicated an enormous amount of time well beyond what was anticipated. Special thanks for the great work from the project team McFarlane Green Biggar of Tracey Mactavish, Seng Tsoi, Kate Snyder, Laura Radford and Bryan Beca, the Equilibrium Consulting Team of Eric Karsh, Robert Malczyk, Benny Neylon, the BTY team of Joe Rekab and Sean Durcan and Geoff Triggs of LMDG.

I would also like to thank the Second Edition team from Michael Green Architecture of Harry Olson, Jacqueline Green, Natalie Telewiak, Amanda Reed and our architectural photographers Ema Peter Photography, and Martin Tessler.

**Michael Green** ARCHITECT AIBC, FRAIC, AIA

## **A Note on Intellectual Property**

The FFTT system illustrated in this document is intended for universal use and development with specific copyright conditions. The scale of the opportunity contained in these solutions is enormous and there will be meaningful opportunities for some organizations, companies, and individuals to profit from pursuing these ideas. The decision of the authors and originator of these ideas is to encourage an 'Open Design' (see below for definition) approach that encourages adoption of FFTT into mainstream building practices. This decision underscores our belief that these ideas are stepping stone concepts to the types of systemic change necessary to address climate change issues in the building industry with the increased use of sustainably harvested wood in building structures.

### **Definition of Open Design**

Open design is a movement that promotes an alternative method for designing and developing technology, based on the free exchange of comprehensive design information to balance between the independence of individual designers and the collective power of collaboration.

## TALL WOOD LEADERSHIP

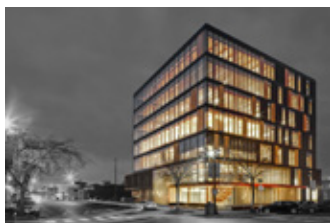

# 2011

## "THE CASE FOR TALL WOOD BUILDINGS" BOOK FIRST EDITION

### **ROOSEVELT CAMPUS**

---

MGA CREATED THIS UNSOLICITED CONCEPTUAL DESIGN FOR THE FUTURE APPLIED SCIENCES AND TECHNOLOGY CAMPUS ON MANHATTAN'S ROOSEVELT ISLAND IN NYC. TO DEMONSTRATE THE POTENTIAL FOR USING THE PRINCIPLES FROM THE CASE FOR TALL WOOD TO CREATE THE BUILDINGS FROM MASS TIMBER. IN PARTNERSHIP WITH CORNELL UNIVERSITY AND TECHNION - ISRAEL INSTITUTE OF TECHNOLOGY.

# 2012

## **NORTH VANCOUVER CITY HALL REVITALIZATION**

---

AN EXPRESSIVE SHOWCASE FOR THE INNOVATIVE USE OF WOOD IN BUILDINGS. CEDAR SUNSHADES WERE REMOVED FROM THE EXISTING BUILDING AND THE LARGE TIMBERS WERE MILLED DOWN FOR LANDSCAPE BENCHES GIVING THE WOOD A NEW LIFE IN THE NEW BUILDING.

# 2013

## **TED TALK: WHY WE SHOULD BUILD WOODEN SKYSCRAPERS**

---

MICHAEL WAS INVITED TO SPEAK AT TED IN LONG BEACH, CALIFORNIA. FORGET ABOUT STEEL AND CONCRETE, BUILD IT OUT OF WOOD... MICHAEL TOLD THE WORLD THAT BUILDING 30 STOREY BUILDINGS OUT OF WOOD WAS NOT ONLY POSSIBLE BUT NECESSARY.

# 2014

## **RONALD MCDONALD HOUSE BC + YUKON**

---

THIS 73 UNIT FAMILY FACILITY USED CLT WALL PANELS IN A 'TILT-UP', BALLOON-FRAME APPLICATION. RMHBC WAS THE RECIPIENT OF A GOVERNOR GENERAL'S MEDAL IN ARCHITECTURE AND A LIEUTENANT GOVERNOR OF BC MERIT AWARD IN ARCHITECTURE.

## **WOOD INNOVATION AND DESIGN CENTRE**

---

UPON COMPLETION, AND UNTIL RECENTLY, THIS EIGHT STOREY MASS TIMBER BUILDING WAS THE TALLEST WOOD BUILDING IN THE WORLD. AMONG ITS MANY AWARDS, WIDC WAS THE RECIPIENT OF A GOVERNOR GENERAL'S MEDAL IN ARCHITECTURE AND AN RAIC AWARD OF EXCELLENCE FOR INNOVATION IN ARCHITECTURE.



## **TECHNICAL GUIDE FOR THE DESIGN AND CONSTRUCTION OF TALL WOOD BUILDINGS**

---

MICHAEL WAS A CONTRIBUTING AUTHOR TO THIS FPINNOVATIONS PUBLICATION THAT WAS INITIATED BY NATURAL RESOURCES CANADA.

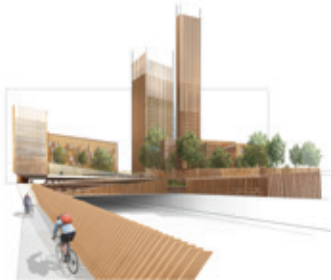

## **2015**

### **MGA WAS A STRATEGIC PARTNER IN THE METSÄ WOOD INITIATIVE**

---

AN EXPLORATION INTO THE BOUNDARIES OF WOODEN SKYSCRAPERS. THE EMPIRE STATE BUILDING CASE STUDY BEING THE MOST NOTABLE.

## **2016**

### **RÉINVENTER PARIS**

---

THIS PROPOSED INVENTIVE URBAN PROJECT FEATURED THE WORLD'S TALLEST WOOD BUILDING AT 35-STOREYS AND WOULD SEE PARIS DEFINE THE NEXT ERA OF CITY BUILDING. TEAM: DVVD AND REI FRANCE.

### **T3 MINNEAPOLIS**

---

THE LARGEST MODERN MASS TIMBER BUILDING IN THE UNITED STATES. THE SEVEN-STORY, 220,000 SQ FT COMMERCIAL BUILDING OFFERS A MIX OF RETAIL AND OFFICE SPACE, INTEGRATING INTO EXISTING TRANSIT NETWORKS AND THE HISTORIC FABRIC OF THE CITY. T3 IS A UNIQUE APPROACH TO OFFICE BUILDING AND AN INVESTMENT IN BOTH THE PAST AND FUTURE OF MINNEAPOLIS – SPECIFICALLY THE RICH HISTORY OF THE WAREHOUSE DISTRICT.

## **2017**

### **PUBLISHING RELEASE OF 'TALL WOOD BUILDINGS' BOOK**

---

CO-AUTHORED BY MICHAEL AND JIM TAGGART, THIS BOOK PROVIDES AN INTRODUCTION TO THE TECHNOLOGY BEHIND TALL WOOD CONSTRUCTION SYSTEMS. THIS BOOK IS AVAILABLE IN ENGLISH AND GERMAN. PUBLISHED BY BIRKHÄUSER.

### **TIMBER ONLINE EDUCATION**

---

TO ADVOCATE FOR WOOD CONSTRUCTION, MGA AND DESIGN BUILD RESEARCH HAVE INITIATED THE TIMBER ONLINE EDUCATION PROJECT, AN ONLINE EDUCATION PROGRAM AIMED TO INSPIRE CURRENT AND FUTURE PROFESSIONALS FROM ALL WALKS OF INDUSTRY – SERVING ANYONE FROM DESIGNER TO DEVELOPER, CONTRACTOR TO CODE WRITER.

## MGA PROJECTS

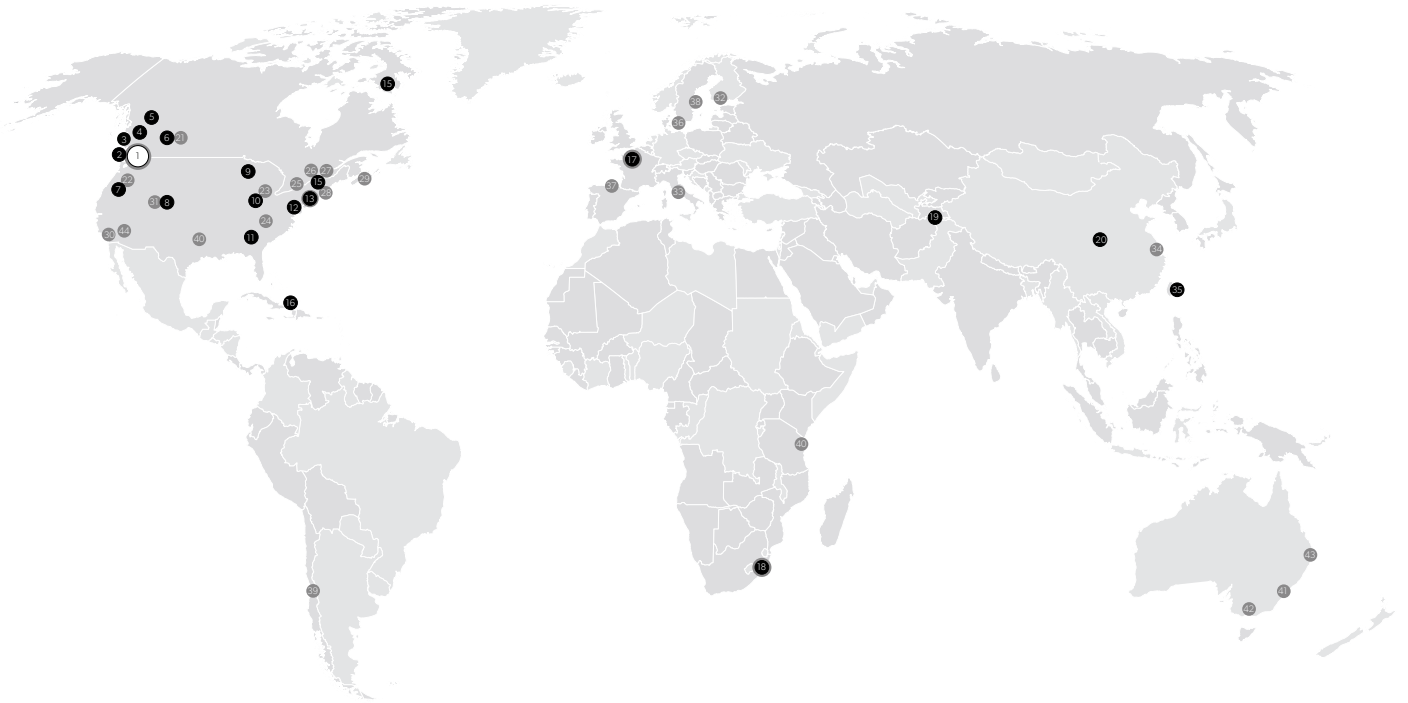

- 5-50 PROJECTS
- 1-5 PROJECTS
- LECTURES
- LECTURES + PROJECTS

- |                             |                             |                            |
|-----------------------------|-----------------------------|----------------------------|
| 1 VANCOUVER, BC, CAN        | 16 TURKS AND CAICOS ISLANDS | 31 SALT LAKE CITY, UT, USA |
| 2 VANCOUVER ISLAND, BC, CAN | 17 PARIS, FRANCE            | 32 HELSINKI, FINLAND       |
| 3 WHISTLER, BC, CAN         | 18 DURBAN, SOUTH-AFRICA     | 33 ROME, ITALY             |
| 4 PRINCE GEORGE, BC, CAN    | 19 KHOROG, TAJIKISTAN       | 34 SHANGHAI, CHINA         |
| 5 FORT ST. JOHN, BC, CAN    | 20 XI'AN, CHINA             | 35 TAICHUNG, TAIWAN        |
| 6 CANMORE, AB, CAN          | 21 CALGARY, BC, CAN         | 36 COPENHAGEN, DK          |
| 7 CORVALLIS, WA, USA        | 22 PORTLAND, OR, USA        | 37 BILBAO, SPAIN           |
| 8 SUMMIT EDEN, UT, USA      | 23 CHICAGO, ILL, USA        | 38 STOCKHOLM, SE           |
| 9 MINNEAPOLIS, MN, USA      | 24 NASHVILLE, TN, USA       | 39 SANTIAGO, CL            |
| 10 SPRINGFIELD, ILL, USA    | 25 TORONTO, ON, CAN         | 40 MOMBASA, KE             |
| 11 PEACHTREE, GA, USA       | 26 OTTAWA, ON, CAN          | 41 SYDNEY, AU              |
| 12 WASHINGTON, DC, USA      | 27 MONTREAL, QC, CAN        | 42 MELBOURNE, AU           |
| 13 NEW YORK, NY, USA        | 28 NEW HAVEN, CT, USA       | 43 BRISBANE, AU            |
| 14 ESSEX, NY, USA           | 29 HALIFAX, NS, CAN         | 44 TUCSON, AZ, USA         |
| 15 IQULUIT, NU, CAN         | 30 LONG BEACH, CA, USA      |                            |

## In Brief

### **THIS REPORT INTRODUCES A NEW WAY OF DESIGNING AND CONSTRUCTING TALL BUILDINGS.**

---

The report describes a new structural system in wood that is the first significant challenger to concrete and steel structures since their inception in tall building design more than a century ago. The introduction of these ideas is fundamentally driven by the need to find safe, carbon-neutral and sustainable alternatives to the incumbent structural materials of the urban world. The market for these ideas is quite simply enormous. The proposed solutions have significant capacity to revolutionize the building industry to address the major challenges of climate change, urbanization, sustainable development and world housing needs.

### **The document introduces a Mass Timber solution for tall buildings called FFTT including;**

---

- › Definition of Mass Timber which includes several existing large format panel products in the current marketplace including Cross Laminated Timber (CLT), Laminated Strand Lumber (LSL) and Laminated Veneer Lumber (LVL).
- › Differentiation between Mass Timber and light wood frame.
- › The structural details of FFTT as a “strong column – weak beam” balloon-frame approach using large format Mass Timber Panels as vertical structure, lateral shear walls, and floor slabs. The “weak beam” component is made of steel beams bolted to the Mass Timber panels to provide ductility in the system. Concrete is used for the foundations up to grade. No further concrete is necessary for the system unless selected for architectural reasons.
- › How FFTT is non-proprietary structural solution developed by the authors of this report. Other systems will be possible and introduced as these ideas become more prevalent.
- › How FFTT is adaptable to various architectural forms including office and residential uses and has been conceptually engineered to 30 stories in height for the high seismic areas like Vancouver.

## The report details how FTT addresses;

---

- › The structural characteristics of Mass Timber that enable these solutions including how;
  - a.** Mass Timber (LSL and CLT) is stronger than reinforced concrete (35MPa) in shear capacity
  - b.** Mass Timber (LSL) is equal to reinforced concrete (35MPa) in compression.
  - c.** Mass Timber (LSL and CLT) is stronger than reinforced concrete (35MPa) in tension
  - d.** Mass Timber behaves very well in fire and is significantly different than light wood frame.
- › Life safety issues including fire protection and building code compliance
- › Building envelope issues including thermal performance, water ingress protection, building movement
- › Durability and longevity
- › Acoustic and vibration performance
- › Cost effectiveness
- › Constructability and construction schedule
- › Market and consumer expectations

## WHY THIS REPORT IS IMPORTANT

---

- › **Climate Change:** FTT is a structural solution that has lower emissions and the capacity to store carbon rather than emitting carbon dioxide as concrete and steel do.
- › **Cost Competitiveness:** FTT (Mass Timber) is a cost competitive alternative to concrete for high rise construction to 30 storeys.
- › **Economic Diversification:** The FTT approach and future alternative Mass Timber approaches offer a Value Added option for the Canadian economy, building on the foundation of our sustainable forestry stock.
- › **Rapidly Renewable Resource, Forestry Diversification, and Market Opportunities:** Mass Timber includes CLT that can capitalize on our current forest stock. It also includes an LSL alternative to CLT. LSL is made from fast growth species offering a more rapidly renewable alternative to solid engineered wood solutions.
- › **National and Global Demand:** Urbanization of the world demands alternative safe techniques to build tall buildings in a carbon neutral manner.

## Executive Summary

This study illustrates how Mass Timber products when applied with new structural approaches are significantly different than light wood-frame approaches in their ability to build mid-rise (6-12 stories) and tall buildings (+/- 30 stories). The study details how Mass Timber structures can meet relevant structural design criteria and fire and life safety needs, and do so within cost competitive marketplace conditions. We have framed the many preconceptions that exist for consumers, building code authorities, private developers, and the construction industry and have addressed how those preconceptions can be answered with science, engineering, design and reference information and testing. Finally, we speak to the steps necessary to continue on with this research with increasingly detailed levels of investigation, testing and ultimately prototype buildings that will help introduce tall wood buildings to urban environments around BC, Canada and elsewhere in the world.

For those new to the subject of building structures, it is important that we offer a context for why this study is so fundamentally important in today's building environment. For more than a century mid-rise and tall buildings around the globe have been built predominantly of concrete and steel to achieve great heights. These two incumbent materials have been excellent choices and will continue to be important materials in the construction of all buildings in the future. The questions arise then; why the need for an alternative to concrete and steel for mid-rise and tall buildings, and why now? The answer is simply Climate Change.

Concrete and steel have a large carbon footprint and are highly energy intensive materials to produce. Over the last twenty years, as the world's understanding of Anthropogenic Climate Change has evolved, we have seen the large impact that buildings contribute to the green house gases causing Climate Change. Concrete production represents roughly 5% of world carbon dioxide emissions, the dominant green house gas. That reflects more than 5 times the airline industry as a whole. It is clear that the very fundamentals of what we build with are worth re-evaluating.

The essential shift that we will discuss is how the unique properties of Mass Timber and indeed all wood, when harvested responsibly, reflect an important and effective tool in reducing greenhouse gas emissions, and in fact storing carbon in buildings. Wood's ability to store carbon makes it a very important challenger to steel and concrete as a chosen building structure. For wood to be a viable alternative it must cost effectively compete and structurally perform at larger heights than previously imagined. This is one driving force behind research that is happening in several parts of the world studying tall wood buildings.

The study will show that buildings from 10 to 30 stories can be achieved using new mass timber techniques and will discuss how and why these buildings will become important choices within the marketplace of the future.

It is the opinion of the authors of this study that the implementation of the ideas within this document will revolutionize the construction industry for mid-rise and tall building typologies. It is important for readers to understand that this is a conceptual design solution and that time, additional testing and engineering, and building code evolution will be necessary before considerable heights are realized in built form.

### Historic and Global Context

Tall wood buildings are not a new concept. 1400 years ago tall pagodas in Japan were built to 19 stories in wood and still stand today in high seismic, wet climate environments. Several countries around the world have a history of building tall including examples here in Vancouver of 7 and 10 stories in heavy timber that have stood for the last hundred years.

Current innovations worldwide have triggered a race for increasingly tall wood buildings. The 9 storey Stadhaus building in London illustrated how tall wood can be a competitive system in the marketplace. Recent initiatives include a proposed 10 to 12 storey building in Melbourne Australia, a 17 storey proposal in Norway and a 30 storey hybrid timber and concrete proposal in Austria. Each of these proposals takes a different structural approach to mass timber construction. Each illustrates the development and expansion of this important new market.

### What is Mass timber?

The important shift that this report will address is the fundamental difference between small scale dimensional lumber solutions (light wood frame) and Mass Timber construction. Mass Timber is defined as solid panels of wood engineered for strength through laminations of different layers. The panels vary in size but can range upwards of 64 by 8 feet (20m x 2.4m) and in the case of CLT can be of any thickness from a few inches to 16 inches or more. Ultimately these are very large, very dense solid panels of wood. The three primary mass timber products that we will discuss are:

- › Cross Laminated Timber (CLT) made from layers of solid wood set at 90 degree orientations.
- › Laminated Strand Lumber (LSL) made from a matrix of thin chips.
- › Laminated Veneer Lumber (LVL) made from thin layers of wood similar to that of jumbo sheet plywood.

These Mass Timber products offer significant benefits over light wood frame techniques in fire performance, acoustic performance, structural performance and scale, material stability and construction efficiency. Educating the public on the difference between wood stud and Mass Timber is an important effort in bringing these ideas to the market.

## Wood and Climate Change

Wood is the best principal material available for building structures when considering total energy use, carbon emissions and water usage.

Sustainable forest management and forest certification are fundamental to the increased use of wood. The ability for the public to embrace an increase in wood buildings comes with a strong understanding of the overall impact on BC, Canada, and the world's forests. Deforestation is a critical contributor to anthropogenic climate change. The concept of using more will only be embraced when the harvesting of wood is understood to be truly sustainable and responsible to the environment.

The diversity of the forest ecosystem will be informed in part by the evolution of LSL solutions in compliment with CLT. Faster growth birch and aspen are used in LSL which becomes a viable mass timber option in the proposed FTTT system. The ability to increase forestry diversity may provide net economic and forestry security in BC and Canada.

## Structural/Height Findings

Mass Timber buildings are changing the scale of what is possible to build around the world. Different systems will continue to evolve but our FTTT system proposed herein can efficiently achieve heights of 30 storeys in a primarily all-wood solution (with steel beams). The CREE system in Austria has illustrated that a 30 storey hybrid wood and concrete structure is possible.

The FTTT system has been engineered to address the seismic codes for the Vancouver market. The engineering has shown that in the case of a wood structure it is the wind load on the building that governs the design more than earthquake forces. This is notably due to the significantly lighter weight of a wood structure compared to a concrete structure. The relative weight difference between a wood structure and a concrete structure results in savings on foundations that are particularly relevant in poor soil areas where foundation costs can be high.

The FTTT system is a predominantly wood system with a solid wood central elevator and stair core and wood floor slabs. Steel beams are used to provide ductility in the system to address wind and earthquake forces. Concrete has been used for the below grade areas of the structure.

Wall thicknesses of the Mass Timber are comparable or thinner than concrete walls due to the dramatic difference in the fundamental weight of the building. This means that there is no floor area penalty to a developer interested in a FTTT building.

FTTT system allows for open plans that will accommodate both office and residential uses.

## Building Code/Life Safety Findings

The current building height limit for wood buildings in BC is 6 storeys. This height limit was determined with light wood-frame (wood-stud) structures in mind. Mass Timber buildings are significantly different than light wood-frame buildings in their fire performance due to the solid nature of the timber panels and their inherent ability to resist fire without the addition of protective membrane barriers. Appropriately designed Mass Timber buildings will not create the combustible concealed spaces that are problematic with light wood-frame construction. In addition to the typical 'active' fire protection systems (automatic sprinkler systems, fire alarm and detection systems) there are two primary "passive" approaches to achieving the necessary structural fire protection of the Mass Timber structures:

### Charring Method

Although wood is considered a combustible material, well designed heavy-timber (large wood column and beam) and Mass Timber (panel product) structures have been recognized as having good performance in fire by North American and International standards. This is due to the fact that in heavy timber and mass timber construction there is a sufficient mass of wood that a char layer can form (incomplete combustion) and that in turn, helps to insulate the remaining wood from heat penetration. Once ignited, structures classified as "heavy timber" exhibit excellent performance under actual fire exposure conditions. Due to the ability of wood to form a protective char layer during combustion, the fire-resistance rating of large-sized members can be calculated based on minimum structural thicknesses and the remaining sacrificial thickness available for charring. This fire safety design approach is of particular interest as it is consistent with the technical analysis of Mass Timber structures in Europe and would ultimately facilitate the most sustainable design solution for fire protection in tall wood buildings. The charring approach is being used in other international jurisdictions.

### Encapsulation Method

The alternate approach to ensuring adequate fire performance of the mass timber assemblies is an encapsulation method applying 2 layers of fire-rated gypsum board within each compartment and generally throughout the building, similar

to standard construction techniques used to construct fire-rated floor, roof and wall assemblies in both combustible and noncombustible building types. This approach is highly feasible and acceptable as a means of addressing the applicable Code requirements.

## Architectural Findings

While on the surface this exercise is about defining a universal structural system with FFTT to engineer tall wood buildings, it is important to understand a number of architectural issues that are essential to the system's success. The report has intentionally steered away from illustrating the 'look' of a finished building to leave the ideas open to the imagination of all architects.

FFTT allows for flexible tower planning and façade design to the height of 30 stories currently studied. Flexibility is very important for a number of reasons:

1. An open plan (where there are no interior structural partition walls) allows for a variety of uses including office or residential.
2. Developers typically look to flexibility in the structural system to ensure they can manipulate the solution to meet their market goals. Open plans give enormous design flexibility to developers and architects.
3. Exterior character and massing are important to adjust to the specifics of a given site, setback requirements, views and view corridors, shadowing conditions or architectural expression.

In addition to understanding the impacts on flexible planning, the report reviews building envelope conditions, acoustic conditions, systems integration and provides example details to show how various components work in addressing fire and life safety requirements. In general we have found that FFTT is a viable solution from all planning, technical, and aesthetic perspectives to satisfy the typical needs of a tower design.

## Industry Perception

Our interviews with contractors and developers resulted in a host of revealing information. Contractors initially struggled to know who they should bring to our meetings. Is this a wood building where wood-framing trades will be suitable or is this more like a concrete tilt-up building or a steel frame building? The answer certainly proved to be that these solutions warrant the skills of tall building contractors foremost and that FFTT is perhaps most akin to tilt-up concrete in the way it is erected. There was also

discussion of the effective speed of erection and how that factors in the overall cost of a project. It was felt that a high efficiency tall concrete building in Vancouver where the industry has honed some exceptional skills would allow a floor to be erected in 4 to 7 days in concrete. It was felt this could be significantly faster in FFTT depending on the level of pre-assembly on the ground and the area for lay down of the material and access to the site for regular panel delivery.

Developers saw a different set of issues and most often wanted to understand the perceived risk. Would consumers buy into these tall wood buildings? How would a developer position the building in the market? Would it impact long-term resale? How will the first tall wood buildings be best realized? What would it feel like to live in a tall wood building? Would it have vibration issues as trucks drive by? The general conclusion to these questions was one of needing several realized prototype buildings. The feeling was that a public-private partnership or public incentive might be necessary for the first to reach the market. Cost effectiveness would ultimately be the determining factor.

## Market Perception

Our interviews with Vancouver real estate marketing groups revealed a number of challenges and opportunities around realizing Tall Wood projects in the private sector. The most significant challenge is that wood is perceived in Vancouver by many as a less durable and less enduring material than concrete. Vancouver's "Leaky Condo Crisis" where many wood frame buildings experienced moisture problems due to envelope failure, has resulted in a strong perception that concrete is a preferable material choice with better long term value and performance.

The recommendations of marketing groups emphasize the need to reposition wood in the market by speaking to the unique qualities of Mass Timber. Suggestions were made to market specifically to high-end projects at the outset to benchmark these new structures at the top of the market. It was felt that trickling down to more affordable developments would be easier than starting solely on the basis of affordability and trying to expand into the higher-end market. It was recommended that positioning initial designs as "exceeding the building code" might be a good means of introducing the systems.

In general the concepts of tall wood, once understood, were received very positively with a sense of ambition that an effective marketing campaign and strategy would successfully deliver the message to consumers. The marketing groups also expressed a need to find ambitious developers interested in showing industry leadership with initial projects but that other developers would follow if the strategy was well executed.

## Cost Findings

The cost analysis calculated the project costs for both 12-storey and 20-storey FTT options utilizing both the charring and the encapsulation approach to fire protection. Concrete was used as a benchmark structure to compare costs with wood. Location factors were then applied to these numbers to further understand applications in different regions of BC.

FTT offers options of using various Mass Timber products. By designing for CLT, LSL or LVL options we have worked to broaden the cost competitiveness of the marketplace. Each Mass Timber product has unique properties and may be ultimately chosen for architectural as well as structural reasons. CLT production is just emerging in Canada and we have assumed that its pricing will stabilize at a competitive rate with LSL over time to compete for these types of applications.

The estimated costs were developed based on preliminary design drawings that are demonstrated in this document. The

estimates offer a Spring 2011 costing that could form the basis for developing a project design. More precise estimates based on more detailed design information would most likely vary from this baseline. Our research uncovered an industry expectation that as the design development of FTT building advances, there will be significant improvement in the savings to be realized for this type of construction.

The future of carbon pricing will be undoubtedly beneficial to Mass Timber solutions. BC's carbon tax today impacts the energy costs used in the production of concrete but largely does not impact steel pricing that is imported from other regions. The low energy use in wood harvest and manufacture makes Mass Timber a lower risk material in the future, one that it is less vulnerable to energy price fluctuation and carbon emission penalties. Future mechanisms to provide owners with carbon sequestration incentives will arguably make Mass Timber even less expensive than concrete in BC.

Region	12 Storey Concrete Frame	12 Storey FTT Charring Method	12 Storey FTT Encapsulation Method	20 Storey Concrete Frame	20 Storey FTT Charring Method	20 Storey FTT Encapsulation Method
<b>Vancouver</b>	\$ 17,550,800	\$ 17,518,000	\$ 17,856,200	\$ 30,097,900	\$ 30,297,100	\$ 30,989,900
	<b>\$ / sf</b>	<b>\$283</b>	<b>\$283</b>	<b>\$288</b>	<b>\$292</b>	<b>\$294</b>
<b>Northern BC</b>	\$ 19,832,404	\$ 19,269,800	\$ 19,641,820	\$ 34,010,627	\$ 33,326,810	\$ 34,088,890
	<b>\$ / sf</b>	<b>\$320</b>	<b>\$311</b>	<b>\$317</b>	<b>\$330</b>	<b>\$323</b>
<b>Interior BC</b>	\$ 18,779,356	\$ 18,393,900	\$ 18,749,010	\$ 32,204,753	\$ 31,811,955	\$ 32,539,395
	<b>\$ / sf</b>	<b>\$303</b>	<b>\$297</b>	<b>\$303</b>	<b>\$312</b>	<b>\$308</b>
<b>Fraser</b>	\$ 17,550,800	\$ 17,518,000	\$ 17,856,200	\$ 30,097,900	\$ 30,297,100	\$ 30,989,900
	<b>\$ / sf</b>	<b>\$283</b>	<b>\$283</b>	<b>\$288</b>	<b>\$292</b>	<b>\$294</b>
<b>Vancouver Island</b>	\$ 18,691,602	\$ 18,393,900	\$ 18,749,010	\$ 32,054,264	\$ 31,811,955	\$ 32,539,395
	<b>\$ / sf</b>	<b>\$302</b>	<b>\$297</b>	<b>\$303</b>	<b>\$311</b>	<b>\$308</b>

**Note:** The 20 storey FTT option indicated is based on the Option 2 design. The prices shown increases by \$2/SF for the Option 3 structural approach.



## Recommended Studies

As part of the continuing research and development phase of the Mass Timber building design, it is recommended that the following further studies, physical testing and research/dialogue initiatives be considered to facilitate the project success in the future:

1. **Peer Review**
2. **Public Campaign and Education**
3. **Structural Analysis**
  - a. Advanced dynamic & non-linear analysis of the proposed lateral load resisting systems
  - b. Detailed analysis of typical connection options
  - c. More detailed construction and erection engineering, in conjunction with industry experts
  - d. Detailed cost analysis in conjunction with cost consultants, suppliers and builders
4. **Structural Testing**
  - a. Testing of overall moment frame behaviour, with CLT's as well as LSL/LVL panels
  - b. Testing of typical connections
  - c. Testing of high and low pressure adhesives for the lamination of LSL and LVL panels
5. **Code Discussions Research, Testing, and Evolution**
6. **Market Potential Review and Research in National and Global Markets.**
7. **Pilot Project**
  - a. We believe it would be beneficial to incorporate these studies into the design and construction of an actual pilot project, where costs and construction issues could be tested in real life. We recommend that the height considered exceed that of platform CLT methods already constructed to 9 stories and proposed upwards of 14 stories in other countries. An FFTT prototype of 16-20 stories or higher would illustrate the capacity of the system well beyond the approaches used elsewhere and situate Canada as a leader in this field.
8. **Wood Design, Material Science and Forestry Discussions and Research.**
9. **Cost Evaluation with Steel Alternatives and in National and Global Markets.**
10. **Tall Wood Conference and Strategic Planning for Industry Evolution.**

## Goals of the Study

This report asks and addresses the following questions;

### 1. What heights are technically and economically feasible for tall mass timber buildings in real market conditions?

---

An example site in Vancouver has been selected that will create a real world context for seismic conditions, life safety regulations and competitive marketplace conditions.

### 2. Why should we pursue tall wood building solutions as an alternative to steel and concrete buildings?

---

- a. Climate Argument
- b. Urbanization and the related impact on climate
- c. Economic Diversification
- d. Rapidly Renewable Resource, Forestry Diversification, and Market Opportunity.
- e. Cost Competitiveness

### 3. What unknowns exist for the building of mid-rise and tall mass-timber buildings in the marketplace?

---

- a. Life Safety
- b. Building Code
- c. Acoustic Performance
- d. Building Enclosure
- e. System Integration
- f. Construction techniques and methods
- g. Cost Analysis

### 4. What options do we have to address the restrictions and open the door to mid-rise and tall wood buildings?

---

- a. How will building codes evolve?
- b. What new materials, connection components etc will be needed?
- c. What testing and evaluation will be necessary?
- d. How do we get initial prototypes constructed?
- e. How do we connect the solutions to the public who may have preconceptions?
- f. What are the insurance issues during and post construction?

### 5. Will tall wood buildings be viable in the private marketplace? What are the opportunities for residential construction and office construction?

---

- a. Why will consumers want to buy or rent in tall wood buildings over steel or concrete alternatives?
- b. Why will developers and building owners want to build in wood?
- c. What marketplace biases exist and how can we address them?

### 6. What recommendations can be made to further pursue the proposed ideas in detail?

---

- a. Peer Review
- b. Public Campaign and Education
- c. Structural Analysis
- d. Structural Testing
- e. Code Discussions Research, Testing and Evolution
- f. Market Potential Review and Research in National and Global Markets
- g. Pilot Project
- h. Wood Design, Material Science and Forestry Discussions and Research
- i. Cost Evaluation with Steel Alternatives in National and Global Markets
- j. Tall Wood Conference and Strategic Planning for Industry Evolution



An aerial, black and white photograph of a dense evergreen forest. The trees are packed closely together, creating a textured, repetitive pattern of dark green and grey tones. The perspective is from directly above, looking down on the canopy.

**RESEARCH PHASE**  
**PART 1**



# RESEARCH PHASE

## PART 1

## 1.1 Climate Change, Population Growth and our Forests

### Tall Mass Timber Buildings and Climate Change

For more than a century urban skylines around the world have been shaped by tall buildings constructed with the incumbent materials of steel and concrete. These materials have outstanding structural properties and have been historically appropriate choices for tall buildings throughout the modern era. Architects and engineers have explored the potential of concrete and steel extensively and have developed considerable understanding of their performance in a variety of environments including high seismic and high wind load areas. These materials have enabled buildings to stretch to great heights that are continually being pushed around the world. Fire protection of these materials has also developed over the last century with considerable understanding of how to appropriately protect the structure, the occupants and fire fighters in the event of fire. Today we have a new paradigm that calls into question these two incumbent materials and asks if there are other alternatives with less impact on Climate Change.

Today 50% of the world's population lives in urban environments. UN Habitat estimates that by 2050 roughly 70% of the world will live in urban environments. These environments will continue to demand large building solutions, as urban density becomes an increasingly important part of addressing Climate Change. UN Habitat also estimates that 3 billion people will need a new affordable home in the next 20 years. In today's building tradition this means that mostly concrete buildings will be built to meet this demand. Concrete's large carbon footprint will continue to be a challenge without alternative structural solutions for the world's major urban environments. (UN-HABITAT 2008)

As our understanding of Anthropogenic Climate Change evolves we have come to understand that Green House Gas emissions and in particular the dominant Green House Gas of carbon dioxide has a direct impact on the Green House Effect that is impacting overall Global Warming.

The two ways the world can address Climate Change will be to:

1. Reduce Carbon and other Green House Gas emissions
2. Find ways to store Carbon and other Green House Gases

Wood can contribute to both of these critical tasks.

### Emissions

The building industry represents approximately a third of Green House Gas emissions worldwide. Buildings create these emissions in a number of ways but primarily through direct energy use for heating, cooling and electricity and through the embodied energy within the materials of the buildings themselves. Fundamentally the large carbon footprint of buildings must be reduced for the world to address Climate Change.

The effects of embodied energy in structures are significant. In 2004, the Canadian Wood Council launched a Sustainable Building Series. The first publication, Energy and the Environment in Residential Construction, presented operating and embodied energy assessment results, based on life cycle assessment. These results were summarized into six categories: primary energy, greenhouse gas emissions, air pollution, water pollution, solid waste production and resource use. This study included assessment of the following building life cycle stages: product manufacturing, on-site construction, maintenance and replacement, and building end-of-life (demolition and final disposition of materials). While a study of single family housing at a much smaller scale to the mass timber typology proposed, the results are worth discussing here as base statistics:

"The steel and concrete designs embody 26% and 57% more energy relative to the wood design, emit 34% and 81% more greenhouse gases, release 24% and 47% more pollutants into the air, discharge 400% and 350% more water pollution, produce 8% and 23% more solid waste, and use 11% and 81% more resources (from a weighted resource use perspective)." (Canadian Wood Council 2004)

### Carbon Sequestration

Forests accumulate carbon over time, by removing carbon dioxide from the atmosphere and storing this carbon in living trees and plants. Some of this carbon is released back into the atmosphere through decaying trees, forest fires, insect outbreaks, and forest management practices. A forest if managed properly, can act as a large carbon reservoir, reducing the amount of carbon emissions in the atmosphere by increasing the absorption potential of the forest itself. Replacing the use of the materials of steel and concrete with wood structures is therefore an important component in addressing climate change. When a tree is manufactured into a lumber product, the carbon accumulated in the tree is sequestered and stored within that product for its complete life cycle. Wood stores somewhere between 1 to 1.6 tonnes of carbon dioxide per cubic meter of wood depending on species, harvesting methods and secondary manufacturing methods. (FPInnovations 2011) A typical North American timber-frame home captures about 28 tonnes of carbon dioxide, the equivalent of seven years of driving a mid-size car or about 12,500 liters of gasoline. (BREAAAM 2010, Naturally wood 2010). The success of carbon sequestration relies on sustainable forestry practices as well as strategies for management of wood products at a building's end of life. If mass timber building systems were to become common in the building industry, the amount of carbon sequestration that would take place would significantly change the role that wood products have in reducing carbon

emissions in the atmosphere. This is even more significant for products that use rapidly renewable growth cycle species (such as LSL which is produced from poplar and aspen species on a 10 year growth cycle).

Until recently there was simply no need to innovate a new structural solution for mid-rise and tall buildings. The impacts of Climate Change raise the need to look to better solutions than steel and concrete. Wood will be an important part of the solution. This is not to say that concrete and steel will be eliminated from construction. Indeed hybrid solutions of wood, steel, and concrete will be necessary. Each has a purpose but in the end increasing wood use in large buildings is a viable approach to carbon-neutral building structures.

### **Sustainably Managed Forests**

The realization of mid-rise and tall wood buildings will, in time, dramatically increase the demand for wood. This raises a valid question of whether the world has enough forest resources to sustainably support such an initiative. A key component to answering this question is understanding the difference between deforestation and sustainable harvesting of our forests.

Deforestation is the permanent conversion of forest to non-forest uses such as agriculture or urban development. Sustainable harvesting is the removal of trees with long term replanting and species diversification inherent in the planning process; the forest remains a forest. Sustainably managed forests are necessary to support the economic and carbon sequestration arguments for mass wood building systems. Mainstream acceptance of increased wood use and tall wood buildings in the market requires a strict adherence to the principals of a Sustainably Managed Forestry Sector.

A sustainably managed forest is accredited by Provincial governments setting standards to ensure forests are regenerated properly and in a sustainable manner. Common factors that are incorporated into these standards are the composition of species, the density, distribution, age and height of the regenerating trees, and the distribution of various forest types and age classes across the landscape. Sustainable forest management is monitored by applying a set of indicators, which are objective measures that can be supported by data and by certification systems. The three certification systems that are most commonly used and recognized are the Canadian Standards Association (CSA), the Forest Stewardship Council (FSC), and the Sustainable Forestry Initiative (SFI). These sustainability indicators include biological diversity, ecosystem conditions, economic and social benefits and

society's responsibility. (NRCAN 2011) 35% of Canadian Forests are certified under one of the three certification systems. (Canadian Wood Council 2004)

Basic requirements of credible forest certification programs include:

1. Forest management practices that conform to existing laws.
2. Protection of biodiversity, species at risk and wildlife habitat; sustainable harvest levels; protection of water quality; and prompt regeneration (e.g., replanting and reforestation).
3. Third-party certification audits performed by accredited certification bodies.
4. Publicly available certification audit summaries.
5. Multi-stakeholder involvement in a standards development process.
6. Complaints and appeals process.

### **Notes on Canadian Forests**

Canada has 91% of its original forest cover, and its rate of deforestation has been virtually zero for more than 20 years. (FAO Advisory Committee on Paper and Wood products 2003)

Canada's forests are 94% publicly owned and managed by government on behalf of all Canadians. As a result, the Canadian forest industry operates under some of the toughest environmental laws anywhere in the world, and these laws are strictly enforced.

Only 10 per cent of the world's forests are independently certified, and 40 per cent of these certified lands are in Canada—more than any other country. (Canadian Wood Council 2004)

### **Building Life End**

If at the end of a building's life cycle its wood structure is not transformed into other uses, we will only have succeeded at delaying Climate Change (not reversing it) with a release of stored carbon into the atmosphere through decomposition or burning. The transformation of structural composite lumber to other uses at a building's life end is a fundamental component of a regenerative approach to sustainability.



## 1.2 Context for Tall Wood

### Wood Structures throughout History

Tall wood buildings have existed for centuries. 1400 years ago tall pagodas in Japan were built to 19 storeys in wood and still stand today in high seismic and wet climate environments. Several countries around the world have a history of building tall including examples here in Vancouver of 7 and 10 stories in heavy timber that have stood for the last hundred years. In 2008, the Stadhaus project in London was the impetus for continued innovation in mass timber building - evident in current proposals for bigger and taller buildings in wood up to 30 storeys.

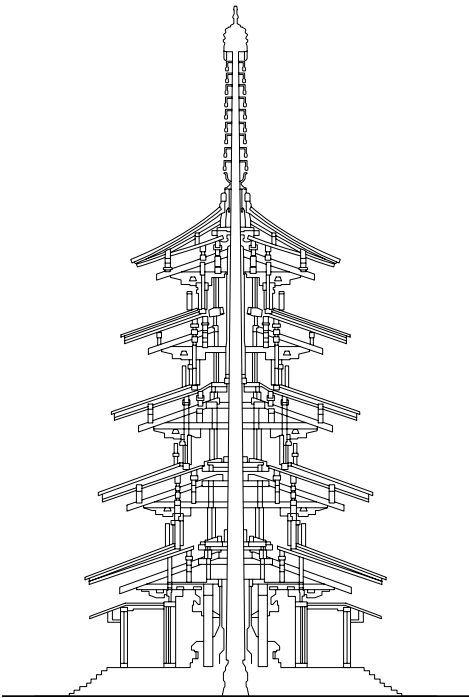

#### Horyu-ji Temple

Architect: N/A  
Date of completion: 603-1603  
Location: Nara, Japan  
Building type: Temple  
Design: 5 Storey pagoda (32.25 Meters / 122 Feet)  
Structure: Central wooden pillar; timber; Japanese joinery

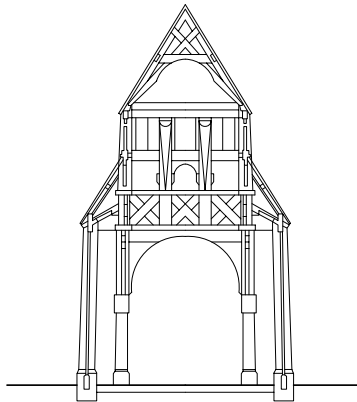

#### Urnes stavkirke Stave Church

Architect: N/A  
Date of completion: 1130  
Location: Norway  
Building type: Medieval Church  
Design: 1 Storey  
Structure: ; Heavy Timber; Post and Beam

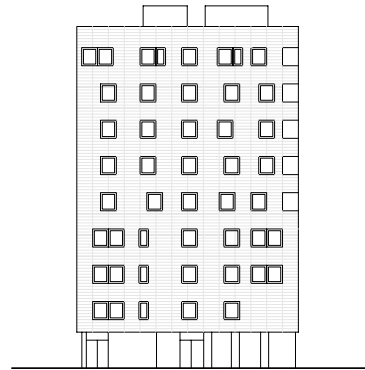

#### Stadhaus, 24 Murray Grove

Architect: Waugh Thistleton Architects  
Date of completion: 2008 Realized  
Location: 24 Murray Grove, Hackney, London  
Building type: Residential  
Design: Nine storey timber tower  
Structure: KLH cross-laminated timber panel system



**Genesis Project**

Architect: CREE  
 (Creative Renewable Energy and Efficiency)  
 Date of completion: 2011 Realized  
 Location: Austria  
 Building type: Mixed Use  
 Design: 8 storey mixed-use tower  
 Structure: Hybrid glulam beams and reinforced concrete slab; pre-fab construction

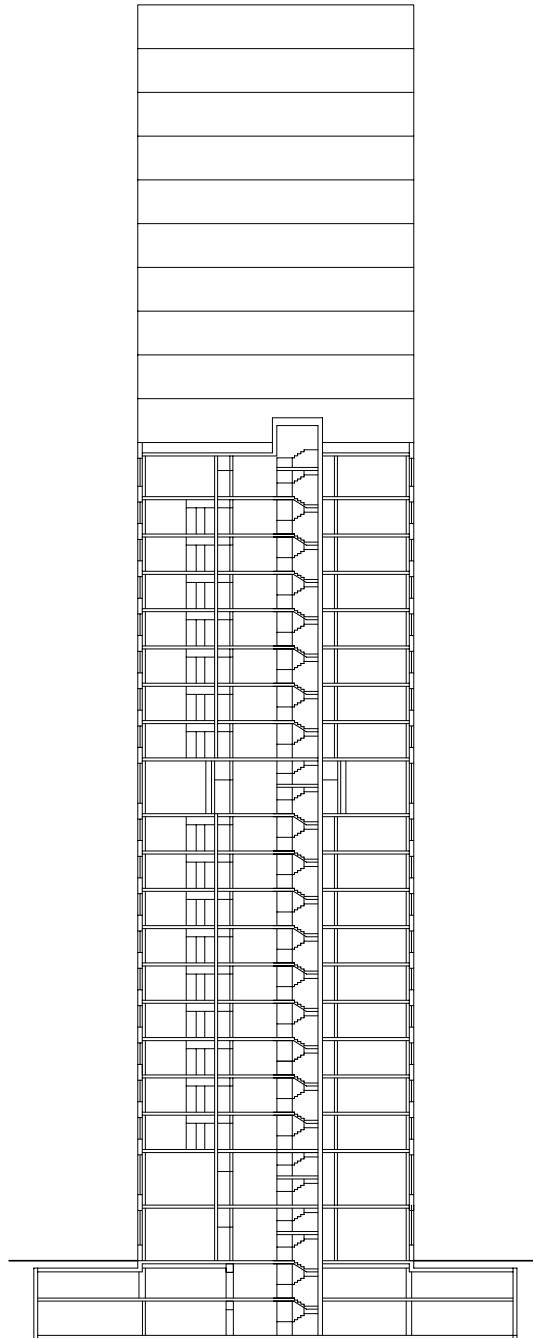

**LifeCycle Tower**

Architect: CREE  
 (Creative Renewable Energy and Efficiency)  
 Date of completion: Unrealized  
 Location: Dornbirn, Austria  
 Building type: Mixed Use  
 Design: 20-30 storey mixed-use tower  
 Structure: Hybrid glulam beams and reinforced concrete slab; pre-fab construction

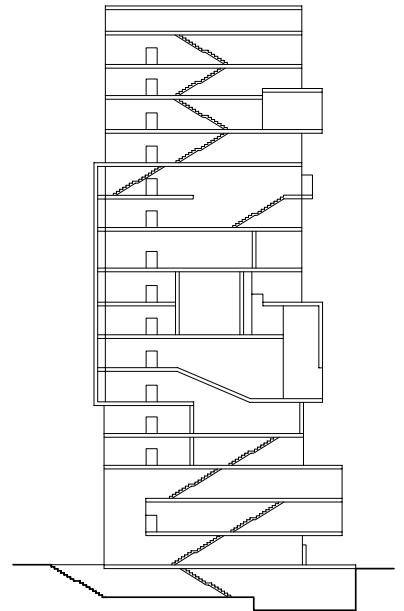

**Barentshouse Kirkenes**

Architect: Reiulf Ramstad Architects  
 Date of completion: 2009 Unrealized  
 Location: Kirkenes, Norway  
 Building type: A center for cultural and innovative interchange between Russia and Norway  
 Design: 16-17 Storey  
 Structure: Wood / N/A

## 1.3 World-wide Reference Projects and Studies

### Stadhaus, 24 Murray Grove

Constructed entirely in timber, the nine-storey high-rise in Hackney is the tallest timber residential building in the world. Comprising of both private and affordable housing, Murray Grove provides twenty-nine apartments.

The building has been assembled using a unique cross-laminated structural system pioneered by KLH of Austria. Andrew Waugh worked very closely with KLH to integrate the technology without sacrificing the design principles. The cross laminated solid timber panels form a cellular structure of platform framed, timber load bearing walls, including all stair and lift cores, with timber floor slabs, and as such making it the tallest pure timber building in the world.

Each of the panels is prefabricated including cut-outs for windows and doors. As the panels arrived on site they were immediately craned into position, dramatically reducing the time on site. The entire nine-story structure was assembled within nine weeks.

The structure of the Murray Grove tower will store over 181 tonnes of carbon. Additionally, by not using a reinforced concrete frame, a further 125 tonnes of carbon are saved from entering the atmosphere. This is equivalent to 21 years of carbon emissions from a building of this size, or 210 years at the current requirement of 10% renewable energy usage.

Regulations in Europe have meant there are no precedents for this scheme. Finland allows only three-storey timber buildings. Austria prohibits timber housing above five floors. However, the engineering methods of timber construction pioneered by Waugh Thistleton and Techniker are now being added to UK Building Regulations in annex form. For the moment, the UK remains the only country to produce the tallest cross-laminated high-rise across the continent.

(Detail 2009)

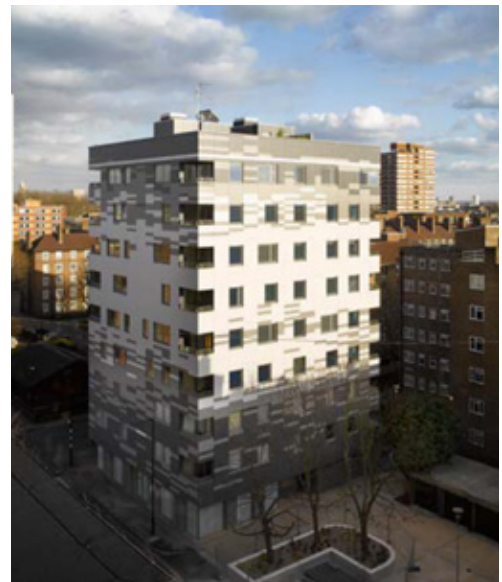

Image: Waugh Thistleton Architects

**Architect:** Waugh Thistleton Architects  
**Date of completion:** 2008 (realized)  
**Location:** 24 Murray Grove, Hackney, London  
**Building type:** Residential  
**Design:** Nine storey timber tower  
**Structure:** KLH cross-laminated timber panel system

## Barentshouse Kirkenes

Recently the Norwegian Barents Secretariat announced plans for a new cultural center that is being touted as the world's tallest wood structure building. The Secretariat hopes that the new structure will serve as a physical symbol of their important role in the High North – a lighthouse of sorts and a beacon of knowledge and development. As part of that role, the new office and cultural center will also act as a model for sustainable building and carbon neutrality.

The new tower by the Secretariat will be located in Kirkenes, Norway and will be 16-17 stories tall and constructed from natural materials with innovative and environmental solutions in all parts of the building. Oslo-based Reiulf Ramstad Architects are responsible for the ambitious project, which will be situated in downtown Kirkenes on the historical ground of a multi-ethnic area.

To achieve carbon neutrality, Reiulf Ramstad Architects is relying on integrated systems that also enable it to adapt to the changing seasons and climate. The firm also plans to reuse biodegradable household and industrial waste to produce bio-gas. Recycled materials from the surrounding area will be incorporated into the design, which is based on traditional architecture from Russia, Sweden, Finland, and Norway.

The interior of the center will house energy-efficient offices for the Barents Secretariat as well as a library, a theater and a creative environment for artists, researchers, students and other relevant institutions. Their goal is that the wood structure building will serve as an example of sustainable construction for the surrounding region while acting as a center for cooperation between Russians, Finns, Swedes, Saamis and Norwegians.

The arctic town of Kirkenes is the hub of regional relations between Norway and Russia. This building will mirror the diverse interchange that is taking place between the two nations and symbolize innovation and open possibility. Wood and timber play an important role in the culture and traditions of both nations. Therefore the concept was to create a single edifice out of wood. The result will be the tallest wood structure building in the world; a multi-functional, architecturally innovative structure that constitutes a pilot project regarding the use of wood in the buildings of tomorrow.

(Meinhold 2009)

LEVEL 17

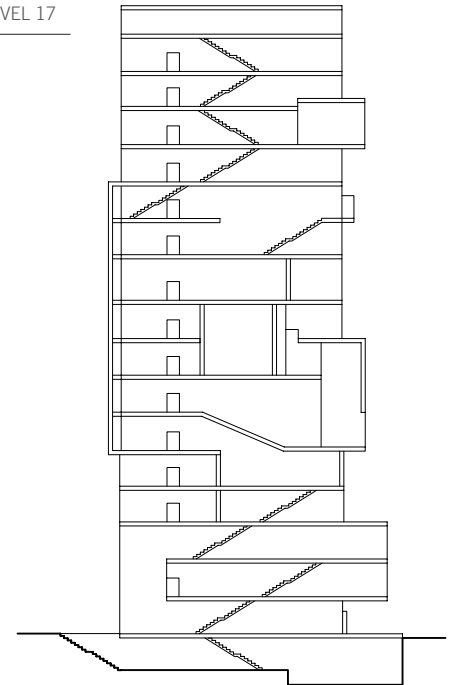

Image: Reiulf Ramstad Architects

**Architect:** Reiulf Ramstad Architects

**Date of completion:** 2009 Unrealized

**Location:** Kirkenes, Norway

**Building type:** A center for cultural and innovative interchange between Russia and Norway

**Design:** 16-17 Storeys

**Structure:** Wood / N/A

## LifeCycle Tower

CREE, (Creative Renewable Energy & Efficiency) is in the process of designing one of the most sustainable high-rise building systems ever conceived. Taking into account the entire carbon footprint and lifecycle of a building, the LifeCycle Tower to be built in Dornbirn, Austria uses wood as its primary structural support. When it is completed it will stand 30 storeys tall, competing for the title of the tallest wood structure building in the world. The building is designed to Passivhaus standards and uses prefabricated building modules that can be erected in half the time of traditional building. An adaptive façade can host solar electric, solar thermal, green panels, or sunscreens, making this a strong candidate for the world's greenest high-rise.

The core of the prefab system is a wooden post and beam construction that supports a concrete slab. The utilities and elevator core of the building can be made from either concrete or wood. The exterior shell is engineered to maximize the walls' r-value and reduce thermal bridging. The system has the potential to qualify for the Passivhaus standards which supports, and in fact encourages, larger buildings.

The design is based on a 1.3 meter grid, and can be used for hotels, offices, apartments, or other needs. The façade utilizes a panelized system which can be manipulated for the client's aesthetic preferences and supports a number of technologies. These include a building-integrated photo voltaic (BIPVs) system, green wall system, solar thermal panels or a second glazing curtain. Systems integrations help make best use of energy resources like solar, biomass boilers and passive cooling thanks to the operable windows.

The wood beam post slab configuration is also very earthquake resistant and holds up to fire without losing as much structural strength as steel. The Glulam beams are set in an interesting horizontal fashion to support the reinforced concrete slab. Utilities and lighting are then run in between the beams. Even the Passivhaus standard windows use wooden frames.

By pushing the limits of one of the most ubiquitous and potentially sustainable building materials and combining it with the benefits of prefab construction and the energy performance of Passivhaus design, the Lifecycle tower comes close to being the ultimate green building. (Michler 2010)

- Architect:** CREE (Creative Renewable Energy and Efficiency)
- Date of completion:** Unrealized
- Location:** Dornbirn, Austria
- Building type:** Mixed Use
- Design:** 20-30 storey mixed-use tower
- Structure:** Hybrid glulam beams and reinforced concrete slab; pre-fab construction

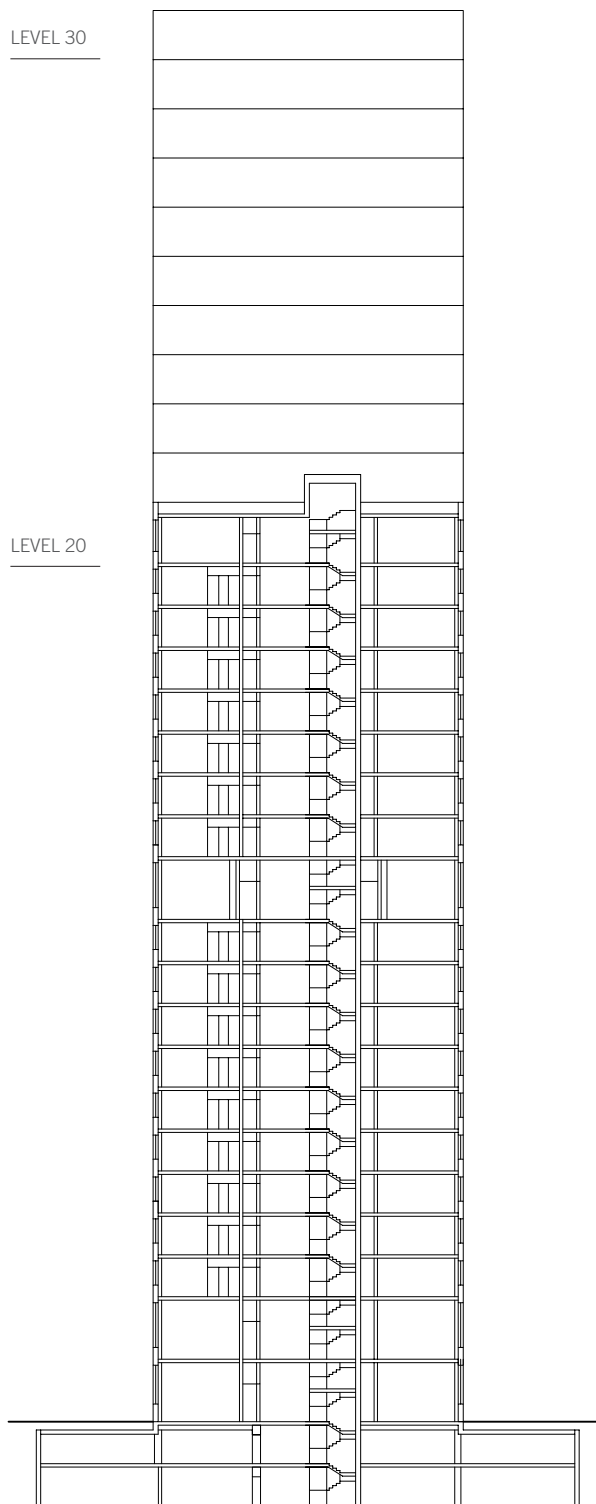

## Barsana Monastery

The Barsana Monastery is considered the tallest wooden structure in Europe standing at 56 meters tall (180 feet). Located in the hills of the Maramures Region in Northern Transylvania, the Barsana Monastery stands as the tallest structure in this convent, built in 1720, consisting of multiple orthodox churches. This monastery was created in post-Communist years and has become a significant cultural and religious attraction.

The Barsana Monastery is built of heavy oak beams on a foundation of large blocks of stone. The plan is rectangular with a polygonal chancel apse that is slightly narrower than the main body of the building. On top of the pronaos rises the wooden spire tower which gives the character of these orthodox churches. A two level porch sits on wooden pillars that form rounded arches on the west façade of the church. This porch was added in 1900 along with larger windows to add lighting to the low chancel level. The naos is in the center of the church which consists of a high barrel vault and two large windows low on the north and south side. The wooden roof covering the main part of the church is supported by two heavy timber consoles and the ends of the upper beams of the wall.

UNESCO has recently designated this part of the Maramures Region as a World Heritage site to preserve the stylized and vernacular wooden architecture of these monastery churches.



One of the smaller churches under repair showing the type of wood construction used in all of the monastery structures.

**Architect:** N/A

**Date of completion:** 1720

**Location:** Barsana/Maramures, Transylvania

**Building type:** Monastery

**Design:** 56 meters (180 feet)

**Structure:** Heavy timber (oak); stone block foundation

## 1.4 Canadian Reference Projects and Studies

### North Vancouver City Hall

The design for the expansion and renovation to the City of North Vancouver's City Hall is currently under construction using a mass timber structure. The project partially renovates the existing 1970's modern heritage City Hall building and expands the facility into a recently vacated library structure. A new bridging atrium creates a new front door for the building and reorganizes the internal departments of City Hall.

While not a tall building, the North Vancouver City Hall project is an exploration of the use of mass timber (LSL) in prefabricated panel form as a new solution for long span floor and roof structures. The mass timber roof structure has been pre-fabricated off-site and assembled on site so as to minimize the disruptions to the working public building. By laminating 4 cross layers of LSL together the panels are 30' long x 12' wide and 14" thick including a 7" void layer between the solid top layer and the intermittent strips of the exposed ceiling layer. The result is a long span panel that allows for services including sprinklers to be integrated within the concealed area of the structure. The structural panel is the finished ceiling eliminating the need for additional finishing of the interior. Equilibrium Consulting engineered the design of the structure.

This solution illustrates how creative paneling solutions can span significant distances in the build up of the FFTT structural solution described in this report.

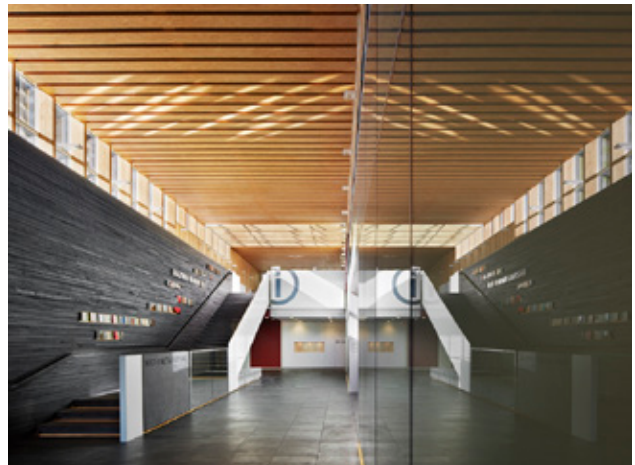

**Architect:** Michael Green, principal  
mcfarlane green + biggar ARCHITECTURE + DESIGN  
**Date of completion:** September, 2011  
**Location:** North Vancouver, BC  
**Building type:** City Hall  
**Design:** Renovation and addition  
**Structure:** Free span LSL panels

Images: MGA | MICHAEL GREEN ARCHITECTURE

## Wood Innovation and Design Centre

The Wood Innovation Design Centre celebrates wood as one of the most beautiful and sustainable materials for building here in British Columbia, and around the globe.

The project was designed by tall wood building advocates Michael Green Architecture (MGA) and constructed by PCL Construction. Equilibrium Consulting designed the innovative structure with MGA. The building is owned by the Province of British Columbia and is used by the University of Northern British Columbia and office tenants. This project is a milestone in the advocacy of increasingly taller wood structures. Michael Green has numerous publications, lectures, and conceptual projects for tall wood buildings. This project allows the concepts for Tall Wood to be tested and built for the first time in North America.

The Wood Innovation Design Centre (WIDC) serves as a gathering place for researchers, academics, design professionals and others interested in generating ideas for innovative uses of wood. The University of Northern BC occupies the lower three floors of the building, with facilities for a proposed Master of Engineering in Integrated Wood Design. Upper floors provide office space for government and wood industry-related organizations. The eight-story building (6 story plus mezzanine and penthouse) stands 29.5m tall — for the moment, the world's tallest modern all timber structure, a record soon to be broken by other mass timber buildings in the works.

With this project, MGA sought to demonstrate economical, repeatable technologies for building high-rise structures with timber, in hopes of inspiring institutions, private sector developers, and other architects and engineers to embrace this way of building. Building in wood sourced from sustainably managed forests offers designers a rapidly renewable, low energy and carbon-sequestering alternative to traditional building materials used for larger buildings.

**Architect:** MGA | MICHAEL GREEN ARCHITECTURE

**Date of completion:** September, 2014

**Location:** Prince George, BC

**Building type:** Mixed Use

**Design:** 8 stories, with a tall floor-to-floor | 6 stories by code definition

**Structure:** Glued-laminated (glulam) columns and beams; cross-laminated timber (CLT) walls; CLT stair and elevator core.

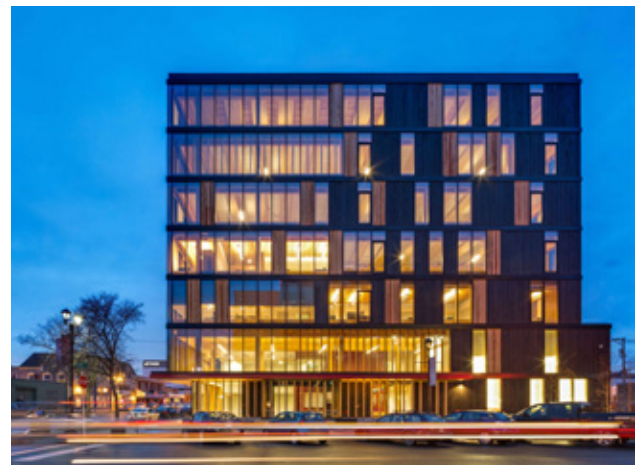

Images: MGA | MICHAEL GREEN ARCHITECTURE



## 1.5 Material and System Research

### Mass timber

Mass timber building systems in this document refer to any of three materials: Laminated Veneer Lumber (LVL), Laminated Strand Lumber (LSL), and Cross Laminated Timber (CLT). These materials each have their own unique properties, but for the purposes of applying them to the FTTT building system, they are essentially interchangeable.

### Why Wood?

Mass timber building systems offer an exciting and innovative solution with possible long term benefits to the building sector, the timber industry and the fight against Climate Change. Wood is one of the most sustainable means of construction and mass timber building systems can offer an efficient solution for large-scale, tall buildings.

In recent years the BC forest industry has been significantly affected by the pine beetle epidemic and mill curtailments. These issues require a shift in the way that we manage and harvest our forests, as well as in the way that we manufacture raw wood into value added product. CLT, LVL, and LSL panels can take advantage of lower grade lumber that otherwise would not be considered for structural uses. After wood is forested, logs are sent to sawmills where it is then sawn into dimensional lumber, broken down into wood chips or planed into veneers. Chips or veneers are either sent to pulp mills or structural composite mills (which could include LSL and LVL). The expanded use of LSL and LVL to take advantage of wood by-products is just one example of how mass timber systems would contribute to diversifying the forest and lumber industry.

Canadian forests account for 10% of the world's forest cover and 30% of the world's boreal forests. Canada has 397.3 million hectares of forest and other wooded land and annually, only less than 1% of Canada's forests are harvested. (NRCAN, 2011) In 2009, the forest industry's contribution to Canada's GDP accounted for approximately 21 billion dollars (1.62%). (Statistics Canada 2009)

Economically, we suggest that the question of relevance should be why **not** wood?

See Section 1.1 for discussion of sustainably managed forests, carbon emissions, and carbon sequestration.

## Cross Laminated Timber

CLT consists of several layers of boards stacked crosswise (at 90 degrees) and glued together on their wide faces and, sometimes, on the narrow faces as well. A cross-section of a CLT element has at least three glued layers of boards placed in orthogonally alternating orientation to the neighboring layers. In special configurations, consecutive layers may be placed in the same direction, giving a double layer to obtain specific structural capacities. CLT products are usually fabricated with three to seven layers.



### Manufacturing Process:

Selection of lumber, lumber grouping and planing, adhesive application, panel lay-up and pressing, and product cutting, marking and packaging.

### Engineering Standards:

Canada and the U.S. refer to APA 320 for engineering standards for CLT. Refer to individual manufacturers for product specifications and standards.

### Fire Ratings:

The Canadian Standard for Engineering Design in Wood (BCBC) can be used to calculate the fire resistance rating of CLT panels along with the same methodology that is currently used for calculating the fire resistance ratings of glulam and "heavy" timber in the U.S. New Zealand, and Europe.

### Adhesives:

Phenol formaldehyde (PF), Phenol-resorcinol formaldehyde (PRF)

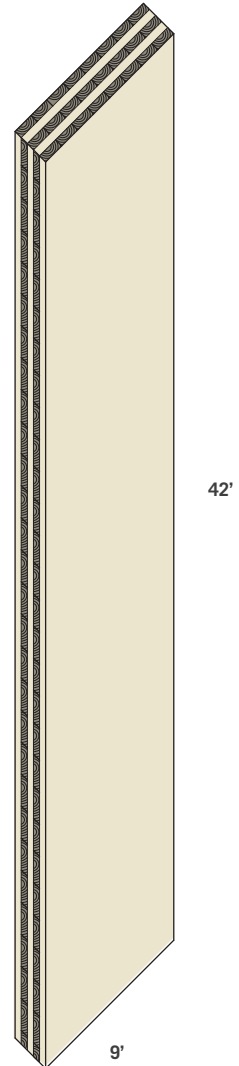

## Laminated Strand Lumber

Laminated strand lumber is a structural composite lumber manufactured from strands of wood species or species combinations blended with an adhesive. The strands are oriented parallel to the length of the member and then pressed into mats using a steam injection press.



### Construction:

Strands are oriented parallel to the axis of the member and pressed into solid mats.

### Typical Canadian Tree Species Used:

Fast growing species such as aspen or poplar.

### Engineering Standards:

Canada and the U.S. refer to LSL as structural composite lumber. Refer to individual manufacturers for product specifications and standards.

### Fire Ratings:

The provisions of IBC Section 721.6.3, design of fire-resistant exposed wood members are applicable to LSL when used as a bending member (beam and header). Fire-rated assemblies are constructed in accordance with the recommendations provided by APA Design/Construction Guide: Fire-Rated Systems, Form W305.

### Adhesives:

Phenol formaldehyde (PF), Phenol-resorcinol formaldehyde (PRF), polymeric-diphenylmethane diisocyanate (pMDI)

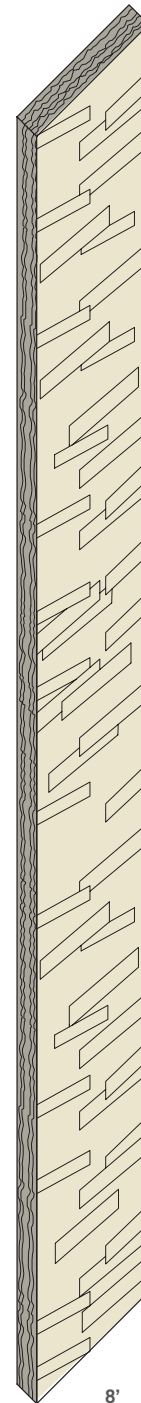

## Laminated Veneer Lumber

Laminated veneer lumber is made up of layers of wood veneers laminated together using a waterproof structural adhesive. The manufacturing process consists of rotary peeling a log into veneers that are then dried and graded for strength and stiffness. After the graded veneers are coated with adhesive they are laid-up into a billet that is then fed into a hot press that cures the adhesive under heat and pressure. The cured and compressed billet then leaves the hot press and is ripped into boards.



A Parallel-lamination process is used where the grain of each layer of veneer runs in the same direction to achieve uniformity and predictability.

### Veneer Thickness:

Ranges from 2.5mm to 4.8mm

### Typical Canadian Tree Species Used:

Douglas fir, larch, southern yellow pine, poplar, and aspen

### Engineering Standards:

Canada and the U.S. refer to LVL as structural composite lumber. Refer to individual manufacturers for product specifications and standards.

### Fire Ratings:

The provisions of IBC Section 721.6.3, design of fire-resistant exposed wood members are applicable to LVL when used as a bending member (beam and header). Fire-rated assemblies are constructed in accordance with the recommendations provided by APA Design/Construction Guide: Fire-Rated Systems, Form W305.

### Adhesives:

Phenol formaldehyde (PF), Phenol-resorcinol formaldehyde (PRF)

(Department of Housing and Urban Development 2010)

(National Research Council Canada 2007)

(APA The Engineered Wood Association 2010)

(Vacca, LP SolidStart Engineered Wood Products and Formaldehyde Emissions 2009) (FPInnovations 2011)

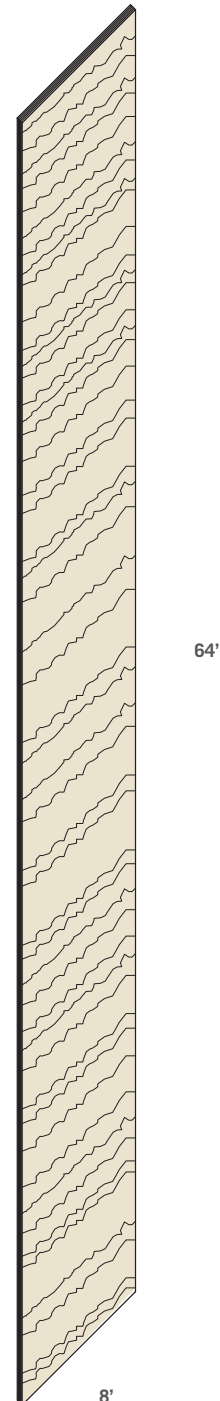

## Adhesives used in Structural Composite Lumber

Adhesives are used in structural composite lumber for lamination purposes and to transfer stresses between adjoining wood fibers. The adhesives used for Structural Composite Lumber products in Canada vary slightly depending on the manufacturer but most panels are composed of phenol-formaldehyde (PF), phenol resorcinol-formaldehyde (PFR) or polymeric methylene diphenyl diisocyanate pMDI adhesives.

The selection, application, and curing of adhesives are controlled at the point of manufacture with extensive testing of physical properties, reliability of bond, performance under environmental factors and emission of VOCs (volatile organic compounds).

### Understanding Formaldehyde

While formaldehyde is commonly known to be an irritant and potential carcinogen, it is important to understand the different formaldehyde based products: UF, PF, PRF and pMDI. Formaldehyde is a naturally occurring chemical that is present in the atmosphere, our bodies and even some vegetables we consume. Exposure to formaldehyde happens on a daily basis because of its presence in the atmosphere and in manufactured products.

Manufactured formaldehydes bind formaldehyde with other chemicals and are used in many products from carpets, upholstery, furniture, and computers to medicines, and vaccines. Different types of formaldehyde compounds have different levels of chemical stability that reduce (high stability) or increase (low stability) their emissions of VOCs under different environmental conditions - impacting human health and comfort.

**Urea-formaldehyde (UF)** is found in many interior and non-structural wood products and is the focus of the LEED Indoor Environmental quality credit 4.4 for Low-Emitting Materials: Composite Wood and Laminate Adhesives. The intent of this credit is to reduce the quantity of indoor air contaminants that are odorous, potentially irritating and / or harmful to the comfort and well-being of installers and occupants. UF is more economical than PF, PFR and pMDI but more readily releases VOCs into the

environment when it is sawn or when it is exposed to moisture. UF is not used in Structural Composite Lumber, nor in CLT. (Emery 2002)

**Phenol Formaldehyde (PF)** is an adhesive derived from the chemical reaction between phenolics and formaldehyde which create a strong bond that is necessary for the composition of any exterior wood adhesive application and eliminates the possibility of VOC emissions.

**Phenol Resorcinol Formaldehyde (PRF)** has similar properties, but is more reactive than phenol-formaldehyde meaning that curing is faster and takes place at room temperature. LVL and LSL manufacturers typically use a blend of PF and PRF because of the higher cost of resorcinols.

**Polymeric Methylene Diphenyl Diisocyanate (pMDI)** is an isocyanate based adhesive. As is the case with PF and PRF, cured pMDI forms a strong bond that is not susceptible to the hydrolysis reaction that would cause the adhesive to release VOCs. Properly hardened pMDI is inert and is proven to be well below any emissions standard. pMDI is limited in use due to higher costs and its unique handling procedures. (Vacca, LP SolidStart Engineered Wood Products and Formaldehyde Emissions 2009)

### Emissions

Emission levels in products that do emit formaldehyde are highest in a new product and decrease over time. Breathing air containing low levels of formaldehyde can cause burning and watering eyes. As levels increase, it can cause burning of the nose and throat, coughing, and difficulty in breathing. Some people may be more sensitive to formaldehyde and have effects at levels lower than expected.

Although formaldehyde in adhesives would be difficult to replace without losing the performance of the product and increasing costs, alternatives to formaldehyde in adhesives are being tested such as soybean based products and other organic materials. The emissions from PF, PRF, and pMDI are well below the standard levels that are considered harmful.

LVL and LSL testing has shown that formaldehyde emissions from these products range from 0.02 ppm to 0.04 ppm. (NRC-CNRC Institute for Research in Construction 2009). Recent testing conducted by FPInnovations has shown that a CLT panel emits between 0.015 ppm to 0.05 ppm. (FPInnovations 2011)

The Environmental Protection Agency considers 0.10 parts per million as elevated (elevated meaning the exposure level that can cause side effects in people). The Housing and Urban Development (HUD) has also set limits on the amount of allowable formaldehyde which may be emitted for building materials and contents at 0.3 parts per million. (U.S. Department of Housing and Urban Development 2007)

The newest formaldehyde limits are being implicated by the California government and are known as the CARB Phase I and Phase II for wood composite products, particleboard, MDF, thin MDF, and hardwood plywood (HWPW) with composite core (HWPW-CC) or veneer core (HWPW-VC). By July 2012, phase II will be enforced and formaldehyde emission limits will vary from 0.13 ppm for thin MDF to 0.05 ppm for HWPW-CC.

All available scientific data indicates that the maximum formaldehyde emissions associated with structural composite lumber panels are equivalent to levels present in outdoor air urban environments. Such low levels of formaldehyde are not proven to cause health concerns and problems.

## 1.6 Evolution of the Building Code

### Historical Summary- Current Developments

Historically, buildings of “combustible construction” have been categorized differently than other “non-combustible” building types, and this has been reflected in the usage of wood-framing/wood products for typically small residential projects, and smaller “low-rise” type commercial buildings only. The history of fire losses in buildings has tended to show that buildings of combustible construction are more vulnerable to the effects of fire than the non-combustible alternative, and this is primarily regulated through limitations of building area and building height in either Part 3 or Part 9 of the applicable building codes in Canada. Although the “Building Size and Construction Relative to Occupancy” requirements of Part 3 have not significantly changed over time, more recent changes to the National Building Code of Canada to permit 4-storey wood-frame construction for Residential buildings, and the B.C. Building Code, to permit 6-storey wood-frame construction, indicate that acceptable levels of safety have been recognized with higher wood-frame structures. This is partially due to the benefits of automatic sprinkler protection and further advances in fire separation/firestopping system testing and technology, which are integrated into these building types as part of the required construction and fire safety measures prescribed by the Code.

One of the shortcomings of the current construction classification systems used in the Canadian building codes is that “combustible construction” as a defined term, and as it is applied in the various construction categories (or Articles of Subsection 3.2.2.), is a general term that is used to describe all construction of combustible or wood materials (i.e., light wood-frame, engineered lumber, TJI’s, heavy timber structure or other mass timber systems). Heavy timber construction is defined separately and is prescribed with minimum dimensional criteria (per Article 3.1.4.6.) to achieve a “45-minute fire-resistance rating”, however it is noted that these prescriptive requirements generally limit the use of heavy timber to buildings of combustible construction, unless “alternative solution” approaches are utilized in the project design.

The User’s Guide to the NBC 1995 states that the NBC “deals with three principal types of construction: combustible, which has little inherent fire resistance unless protected; heavy timber construction, which although combustible has a degree of resistance to structural failure when exposed to fire, and non-combustible construction. Even non-combustible construction may require protection to prevent its’ collapse when exposed to fire because structural steel or reinforcing steel has its’ load carrying capacity reduced at elevated temperatures. The primary difference between combustible and non-combustible construction is that

non-combustible materials do not burn and contribute fuel to a fire. Thus, a basic non-combustible structural frame, if adequately protected from thermal effects of a fire, should remain in place throughout a fire and offer some degree of safety to occupants and firefighters. However, it is recognized that the combustible components permitted in non-combustible construction do burn and will contribute to a fire.”

It is important to note that mass timber systems such as those described in this report are not directly addressed or contemplated in the current building code requirements of the National or Provincial building codes. Mass timber systems are an important and unique type of robust solid wood panel design that is not reflected and does not ‘fit’ within the current building code definitions and classification systems. Although made of combustible materials, the mass timber panels are a structural system that has the ability to resist the effects of fire, either in an exposed unprotected condition, or with protection by common thermal membranes such as gypsum board.

The intentions of this study from a building code perspective is to break down the barriers between the combustible/non-combustible classifications of building codes, and to ultimately demonstrate that a tall building can effectively and affordably be constructed of mass wood materials, without compromising the fundamental principles of the Code; that is, fire safety, structural safety, environmental separation (envelope performance) and other associated health/accessibility objectives. From a fire protection and life safety perspective, the main intention of the study will be to show that material assemblies and structural systems incorporating mass timber systems, will provide an equal level of performance and safety when exposed to conceivable fire scenarios within the interior building spaces (in terms of fire durability of assemblies and fire separation of compartments). Further, this study will examine the occupant safety (both in-situ occupants and emergency responders) parameters that will need to be integrated in the building design, such that the ultimate goal of “life safety” is achieved in the event of a possible fire emergency condition.

From a building code perspective, the primary challenge to be addressed is that a residential building over 6-storeys in building height (and exceeding a limited building area) is required to be of non-combustible construction. The immediate perception from an “Authority Having Jurisdiction” perspective is that a building of 20-storeys, or even 12-storeys in building height and of “combustible construction” will be severely pushing the envelope relative to the fundamental Code principles outlined

above. The proposed Project location is in the City of Vancouver and it is noted that the COV Licenses & inspections Department is accustomed to and favourable towards reviewing well-developed technically supported “performance-based” alternative solution proposals for building designs. The Tall Wood Building concept will be carving new territory for this AHJ, and will require early/frequent engagement in order to be successful. It is also anticipated that Vancouver Fire Rescue Services (as the Fire Department AHJ), will have a conservative and concerned regard to the Tall Wood Building design, as the operation and safety of firefighters and other emergency responders will not be permitted to be compromised during an emergency incident in the building.

In early 2011, the National Research Council, the Canadian Wood Council and FP Innovations joined to initiate the formation of a new consultation group to discuss code changes required to allow taller wood buildings. The group consisted of researchers from the above mentioned groups, design professionals, fire experts, representatives of the concrete, steel and masonry institutes and others.

After a one day meeting held in March in Ottawa, several members of the group concluded that there is a need to change the current height requirements in the code to allow taller wood structures. The main reason was the introduction of new engineered wood materials such as cross laminated timber (CLT) to the Canadian market by several local companies in 2010.

Design professionals, fire experts, and researchers noted that the behavior of solid wood systems such as CLT is completely different than that of light wood frame, which currently dominates the multi-storey wood construction market in Canada. It was noted that structural behavior of solid wood includes much higher strength and stiffness and superior dimensional stability. Fire experts explained the charring effect that differentiates solid wood from light wood systems, which burn much faster.

The group plans to meet again later this year. In the meantime several CLT research projects are being conducted at FP Innovations and several Canadian universities. The summary of this research will be presented to the group at the next meeting. The ultimate goal of this consultation group is to prepare recommendations for NRC enabling changes to the current height limits for solid wood building systems.

A “design brief and objective-definition” meeting with key COV officials was held early in the design development process to identify such that these potential challenges/obstacles can be understood and addressed as the concept design moves forward. The other main challenge that is anticipated for the Tall Wood Building study is the identification of documented and/or recognized fire-tested building assemblies for the various manufactured wood products that are proposed to be incorporated, since most of these assemblies and products will not have any North American test results.



## Building Height and Building Area Regulations

One of the principal roles of the model building code (National Building Code) of Canada is to regulate the size/height of built structures relative to fire safety, and this is primarily achieved by limiting the area/height of buildings incorporating combustible construction, and by requiring incrementally higher fire-resistance ratings for mid-rise to high buildings of non-combustible construction. At the same time, one of the other purposes of the continued development of the NBC, is to incorporate new technologies, materials and methods into the adopted Code requirements, such that they can be readily utilized in the design and construction industry.

Much of the building height and building area regulation in today's building codes are based on historical references and information, which have been perhaps "lost in translation" and are not as critical towards ultimate fire safety within a building as they used to be. For instance, building heights for combustible construction were often linked to the maximum height that a fireman and ladder could reach or the ability of the fire department apparatus/equipment to cover the building relative to water hose stream pressures. With the advent of automatic sprinkler protection in modern-day buildings, these building height limit considerations are not as important relative to fire fighting and fire safety within the building.

Building heights for combustible construction have been limited to 2-3 storeys for most occupancy classifications up until the 1990's at which time the National and Provincial building codes were changed to allow 4 storey wood-frame construction for Residential and Office type occupancies. This fundamental change was made recognizing the benefits of automatic sprinkler systems towards controlling fires within interior compartments of a building as well as protection of occupants evacuating the building during a fire condition. Similar considerations were utilized in developing the recent 2009 change in the Province of B.C. to 6-storey Residential wood-frame construction. It is important to note that the recent changes discussed above contemplate the use of standard light wood-frame construction methods/materials which is a fundamentally different construction system than the mass timber system design that has been developed for this Project.

Relative to "building area" limitations, the historical references of building code development again point towards the reduction of large undivided areas of combustible construction, with the objective of minimizing the damage resulting from severe fire conditions and to aid in fire department manual suppression

activities towards extinguishment of a fire condition. Several large conflagration events occurred in built-up urban areas during the late 1800's due to the uncontrolled and undivided (i.e., no firewalls) construction of wood-frame buildings. The resulting building area limitations of the building codes have been intended to control the ultimate "fire risk" in conjunction with other factors such as the presence of automatic sprinkler protection, level of fire-resistance provided, building height and number of streets the building is facing. For the subject Tall Wood Building design, the building area considerations mentioned above are not as critical with respect to the use of wood materials, in that the building will have a small footprint area (of approximately 500 m<sup>2</sup>) and will be a "standalone" tower design that will be spatially separated from adjoining properties.

However, it is noted that mass timber systems have also been successfully used for larger footprint buildings (i.e., office, retail and warehouse type buildings) in Europe. Therefore, it is noted that this construction type should not be limited in building area, height, or occupancy classification, provided an acceptable level of building performance can be demonstrated for the site-specific building design condition, including adequate protection of adjacent building or property fire exposure in the case of buildings that may maximize the available site coverage.

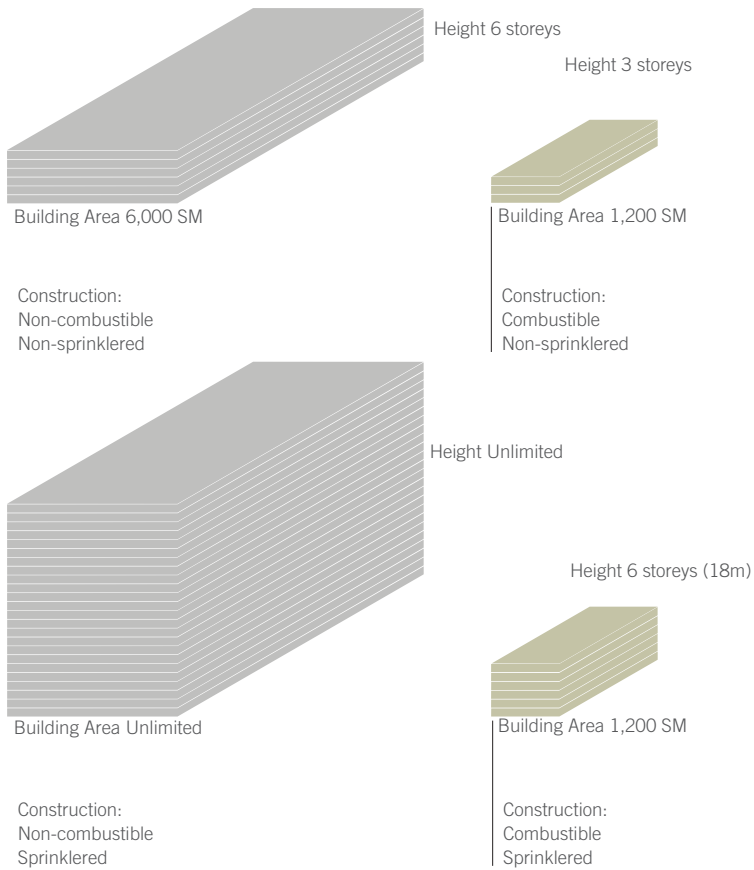

**References:**

Stage 1 Report  
 Building Code provisions for Residential Buildings and  
 identification of Technical and Process Risks  
 October 29, 2008

[www.housing.gov.bc.ca/building/wood\\_frame/6storey\\_form.htm](http://www.housing.gov.bc.ca/building/wood_frame/6storey_form.htm)

British Columbia Building Code 2006  
 (3.2.2.42 and 3.2.2.43)  
 (3.2.2.45 and 3.2.2.46)

**Maximum Building Height and Maximum Building Area by Regulation:  
 Non-combustible vs. Combustible**

## Building Height and the BC Building Code

The regulated building height for combustible buildings in British Columbia has not changed significantly over time, up until the past 20 years as further discussed below. Initially unregulated, height and size restrictions were implemented in North American building codes in reaction to major devastating fires that destroyed large built-up city centers such as San Francisco and Vancouver in 1886.

With the technical advances of fire resistant building materials and the implementation of automatic sprinkler systems, taller wood buildings were deemed feasible and this is reflected in the modern day evolution of Building Code requirements. In 2009, the province of British Columbia made significant changes to its Building Code to allow 6 storey wood frame construction. All of the study and analysis that was done to implement this change was based on the assumption of “stick frame” platform systems - and many believe that this is the economical maximum achievable with this construction system.

Mass timber systems, which behave more akin to concrete structures are very different from stick frame structures in every aspect. Their use in modern day construction will change the way we evaluate the safety of wood in buildings. It is noted that the proposed Tall Wood Building design will push the ultimate building height beyond 18 m, which is the benchmark used in the building code to determine if a building qualifies as a “high building”, in accordance with Subsection 3.2.6. A high building is defined as a building with the uppermost floor level exceeding 18 m above grade and containing a Group C (Residential) occupancy. In the City of Vancouver (where the Vancouver Building By-law applies), any building with a floor level higher than 18 m is classified as a high building, and as such, additional measures are required to provide an acceptable level of safety.

The User’s Guide to the NBC 1995 states, “A high building has a specific group of criteria that distinguishes it from lower buildings. Although the criteria are predominantly established on the basis of height, the real concern is that the occupants may not have enough time to evacuate before smoke contamination reaches lethal levels in some parts of the building.” The purpose of Subsection 3.2.6. for high buildings is threefold:

- › To provide for the safety of the occupants of a building, by maintaining the tenability of occupied floor spaces during a fire emergency, and by providing a means for all occupants of the fire floor to leave that floor quickly;

- › To maintain tenable conditions in exit stairs leading from floor spaces to the outdoors, and in spaces through which occupants have to pass or in which they remain while waiting for assistance to evacuate;
- › To maintain tenable conditions in elevators that are used to transport fire fighters and their equipment from the street floor to the floor immediately below the fire floor and for the evacuation of injured persons or persons with disabilities.

It is noted that in modern-day buildings, the above-noted objectives for occupancy safety and tenability of building floor areas is normally achieved with the installation of automatic sprinkler systems throughout the building (formerly known as smoke-control “Measure A”). This is based on the benefit of automatic sprinklers to rapidly detect, activate and suppress a fire condition at the early stages of development, thereby providing fire control and reduction in smoke production which could ultimately affect occupants in the adjoining “non-fire” compartments of the building. The proposed TWB design will incorporate a complete and enhanced automatic sprinkler system design, as well as other applicable high building measures, to maintain an equal level of safety for the building occupants, to that required by the applicable requirements of Subsection 3.2.6.

The User’s Guide to the NBC also references that, “in high buildings, the smoke that is generated from a burning surface is an additional concern. Since evacuation of a high building takes considerable time to complete, the occupants must be protected from the effects of smoke until they have left the building, or the fire has been extinguished and there is no further hazard. In high buildings, the smoke emission characteristics of wall, ceiling, and floor surfaces are regulated through the imposition of maximum smoke developed classifications. In these buildings, additional restrictions are placed on flame-spread ratings of interior finish materials, in comparison to lower buildings. These additional restrictions apply primarily if the building is not sprinklered.” Therefore, in a sprinklered building the flame spread ratings and smoke developed characteristics are relaxed by the building code, based on the ability of sprinkler systems to detect, control and suppress a fire condition prior to significant burning of surface materials and flashover within a fire compartment.

**Timeline: Building Height by Regulation in British Columbia (Wood Frame Structures)**

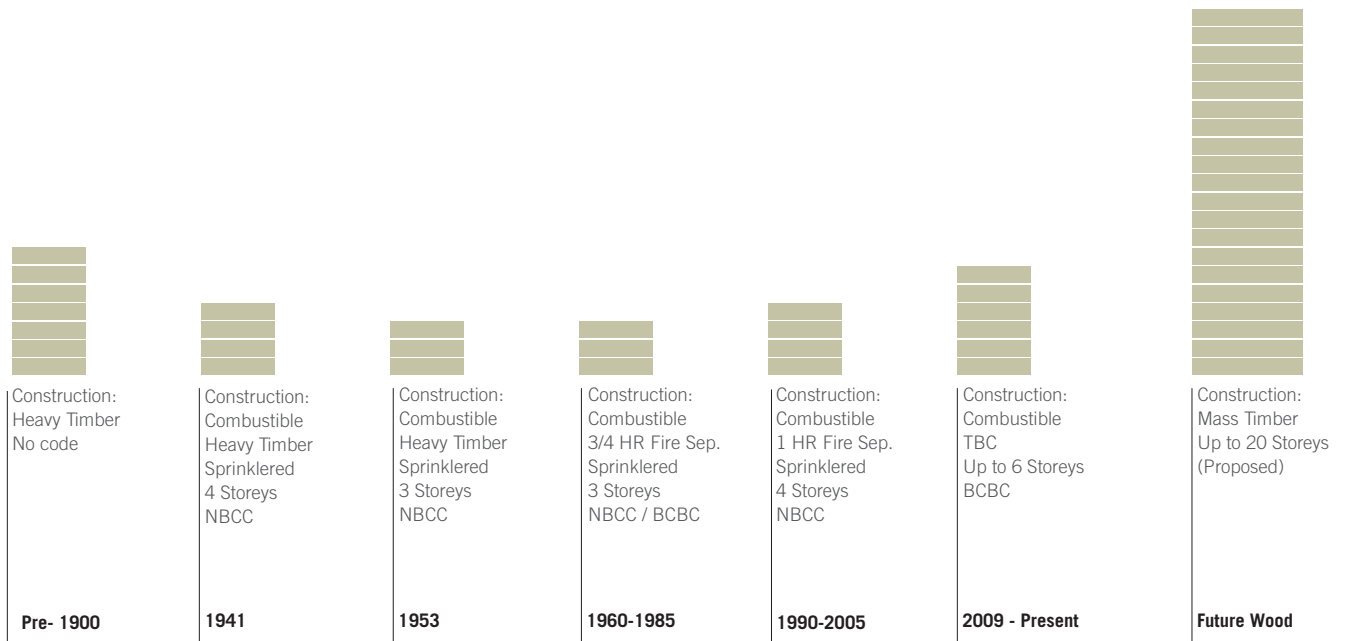

**References:**

A Historical Perspective on building Heights and Areas in the British Columbia Building Code. Table 1: Building Height Limitations in the NBC

Building Code Provisions for Residential Buildings and Identification of Technical and Process Risks. Page 5.

## **International Perspective on Building Height Regulation**

The regulated building height for combustible buildings varies widely across the world. Extremes include Russia, with a limitation of 3 stories, and the United Kingdom that has no specific height limit, provided that a minimum level of safety performance can be demonstrated (i.e., “performance-based” building code regulation), evaluating each project on its specific engineered merits.

As illustrated in Section 1.2 of this report, there are numerous examples of completed/realized or in-design/unrealized mass wood system buildings around the world, with most of the design and manufacturing technology originating in EU nations (i.e., Austria, Germany, Italy, Sweden and the UK). An often referenced example of a completed mass wood building, using “cross-laminated timber” (CLT) panel systems, is the Stadhuas/Murray Grove Project located in London, England. This 9-storey (> 18 m high) residential building incorporates a 1-storey concrete podium with 8-storeys of gypsum-board lined CLT panels for the horizontal and vertical structural systems (including vertical shafts) for the building structural system. The gypsum-board membrane protection installed directly to the CLT panels exceeded the required 90-minute fire-resistance rating required by the local building code regulations, as the gypsum board was primarily installed for marketing/purchaser perception reasons only. That is, the gypsum-board membrane was not required to be installed to achieve the necessary fire-resistance rating for the building, as the exposed CLT panels were of sufficient thickness to achieve the 90-minute fire duration required by the local building code regulations. It is also interesting to note that the Stadhaus Project achieves the required level of safety and fire protection for the local building regulations, without the installation of automatic sprinkler systems in the building floor areas. This is a significant contrast to the Canadian building code requirements, where a building of this height would be required to be fully sprinklered.

Other high building designs utilizing mass timber systems and/or hybrid mass wood/concrete/steel structural systems are currently in development around the world (e.g., Austria, Norway, Australia), and this Tall Wood Building design intended for Vancouver, B.C. is intended to set the standard for Canadian design, construction and manufacturing technology, for the delivery of a economical, safe and durable residential structure of primarily wood materials.

### Maximum Building Height by Regulation (Wood Frame Structures)

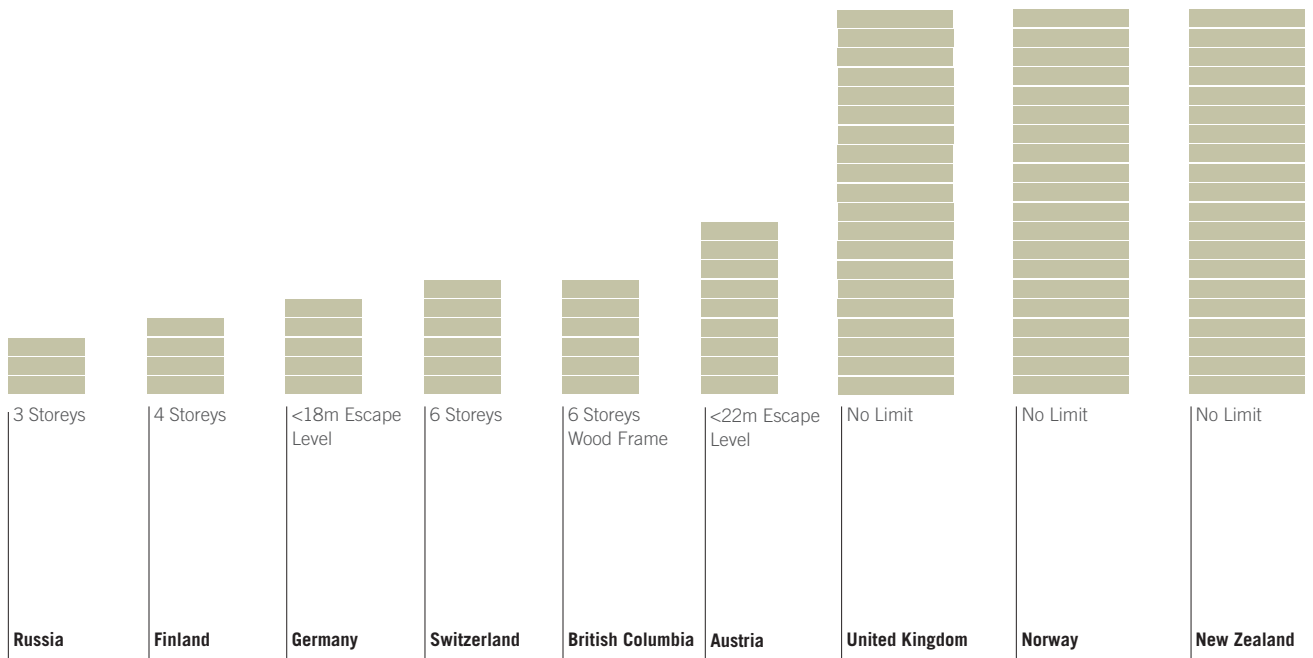

References:  
(Rhombert 2010)





**IDENTIFYING CHALLENGES**  
PART 2





# IDENTIFYING CHALLENGES

## PART 2

## 2.1 Preliminary Survey of Industry Preconceptions

We have tried to track common preconceptions to building tall with wood throughout the study - whether that be through discussions within the industry or with the common public. While we have attempted to address each of these preconceptions at a basic level, Part 5 outlines further work required to fully develop the following to make Tall Wood a built reality.

### COST

---

- › A tall wood structure cannot compete with the economics of a slip form concrete structure.
- › Wood is fundamentally more expensive than concrete.
- › The detailing of a tall wood structure will add more cost to construction.
- › The cost of fire protection will make these structures more expensive.
- › There is not enough competition in the mass timber market to ensure competitive pricing.
- › Who will bear the cost and risk of introducing these ideas in the built form?

### DESIGN

---

- › A tall wood structure will limit the design freedom possible in concrete construction because it will require more walls and more structure and shorter structural spans.
- › A tall wood structure will have thicker walls than its concrete counter part. Walls would be thicker in wood, requiring more floor area.

### CODE

---

- › The fire resistance of a tall wood structure can not replicate the performance of concrete.
- › A tall wood structure is more dangerous than a concrete building (i.e., wood structures are “built to burn”).
- › If there is a fire in a wood building, the entire building/ structure will contribute to the fire and burn to the ground.
- › From a fire department perspective, a tall wood building will not provide an adequate level of safety for firefighters’ or emergency responders who must enter the building to rescue persons or suppress fires.

## **STRUCTURAL**

---

- › Wood is weaker than concrete.
- › A tall wood building will not withstand an earthquake.
- › A tall wood building will not be as safe in an earthquake as a concrete or steel building.
- › A tall wood building will be vulnerable to building envelope failure/leaky condo syndrome - compromising the structure.
- › A tall wood building will deflect excessively in strong wind storms causing discomfort and damage to finishes.

## **PUBLIC OPINION**

---

- › Wood shrinks.
- › Wood rots.
- › Wood burns.
- › Glued wood off-gasses.

## **ECONOMIES | VALUATION | MARKETABILITY | INSURANCE**

---

- › A wood building is exposed to more risk during construction; exposed to moisture and to fire hazard.
- › Wood buildings are valued less than concrete buildings.
- › Insurance premiums are higher for wood buildings than for concrete buildings.
- › Wood cannot compete with the steel and concrete industries.
- › We do not have enough wood supply, impact on forest industry; sustainably managed forests.

## **SCHEDULE**

---

- › A tall wood structure cannot compete with the ability to pour a “floor per week” in concrete construction.





**CASE STUDY DESIGN**  
**PART 3**



# **CASE STUDY DESIGN**

## **PART 3**



### 3.1 Prototype Site and Market Conditions

#### Why use a specific example in Vancouver?

Vancouver currently harbours a cluster of wood construction and design professionals, wood researchers, and fabricators that are on the leading edge of innovative wood design. All of the resources to develop the first Tall Wood prototype are within a very tight radius of collaboration. If it could happen anywhere; it could happen here. For the purposes of this study a theoretical site was selected in Vancouver’s West End neighbourhood.

This location was selected in Vancouver specifically due to the following real-world constraints and opportunities:

1. An urban site within a tight urban grid for construction lay-down area and site access.
2. An appropriate density with residential towers typically ranging from 10 to 20 stories.

3. A highly competitive developer and market atmosphere
4. An insightful consumer profile
5. A high seismic region of BC
6. City zoning that requires efficient design to maximize FSR for competitive developers.
7. Wood construction and design cluster consisting of leading wood researchers, designers, and fabricators.

These parameters establish a challenging context that will allow similar solutions to be applied elsewhere in the province where arguably fewer constraints will exist.



West End  
Vancouver, BC

## 3.2 FFTT Solution

FFTT is a unique tilt-up system that effectively balloon-frames mass timber panels in a cost effective and simple manner to build tall wood buildings. The system uses a strong column – weak beam structural approach that is described in detail later in the report. FFTT was first developed by Michael Green and Eric Karsh in 2008 and has evolved to the current approach described here. Mass timber panels are used for floors, walls and the building core with engineered wood columns (up to 12 storeys) and steel beams and ledger beams (12 storeys and up) integrated into the mass timber panels supporting floors. The introduction of steel allows for the ‘weak beam’ solution and great flexibility for the system to achieve heights with a predominantly all-wood solution.

FFTT uses the integral strength of CLT (available up to 42’ x 9’ in North America), LSL (up to 64’ x 8’) or LVL (up to 64’ x 8’) panel products. These products are manufactured in Canada and use Canadian wood products that can be of a lesser grade than solid timber solutions.

The FFTT system is adaptable to many building types, scales and locations and allows for the fast erection of very simple and structurally sound buildings. We have introduced an example of the use of the LSL panels in the roof structure of the atrium space of the new City of North Vancouver City Hall project currently under construction. The City Hall project illustrates how large panel products can be used in cross lamination to make long span, thin and architectural structures. In the case of City Hall the application is quite specific to the building’s overall architecture but the structural solution is a clear indication of the practical viability of these panel solutions in today’s market conditions.

The diagrams in section 3.15 Constructability, illustrate the assembly concept of FFTT. It is intended to drive the cost of building erection down to make wood solutions cost competitive with steel and concrete and allow wood solutions to achieve significantly greater heights. Its success will be in its ultimate simplicity and the solutions we are developing are driven by the economics and practical realities of building as well as the inherent potential of under utilized mass timber products on the market today.

The solution is also intended to address the reality that wood frame is a solution specific to North America and only a few other markets in the world. Wood frame requires the retooling and teaching of the building industries in foreign markets in order to increase the use of our wood resources. This solution is driven towards a universal system of building that is easily understood and requires little training. It is driven to open a wider market for our wood products by working with international building cultures rather than highly specific North American solutions. We believe it will offer an exportable building industry in time as the panels can be designed, engineered, pre-cut, pre-assembled and then flat packed to become an exportable building structural system.

This solution will move BC from a resource-based wood economy to a value added wood economy benefiting the entire building sector in addition to the timber industry.

### 3.3 Concrete Benchmark

#### Benchmark Solution

In order to fully understand the characteristics of a mass timber building system for tall structures, we have created a concrete base case or benchmark. This enables us to compare solutions back to a building system that is commonly known amongst professionals, the construction industry as well as the marketplace and is a valuable tool in quantifying the magnitude of change, whether it be in detailing, fabrication sequence, or cost of construction.

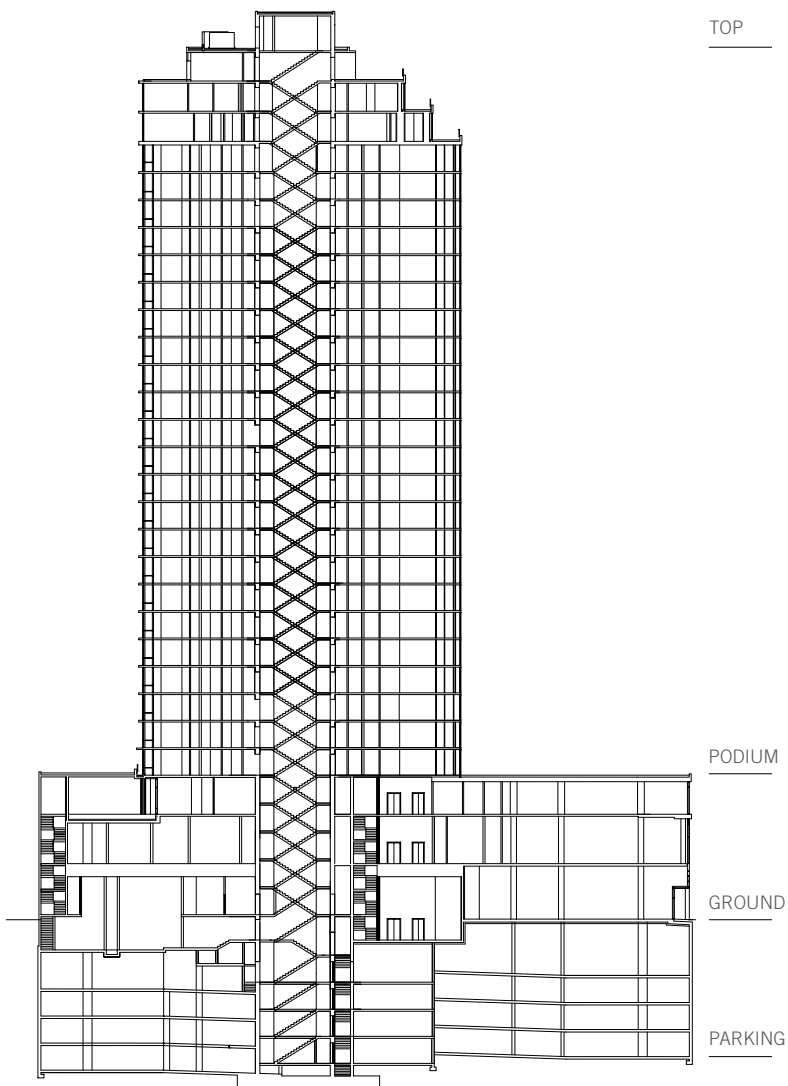

Typical Vancouver Podium Tower Section

**Benchmark Solution Structural Diagram**

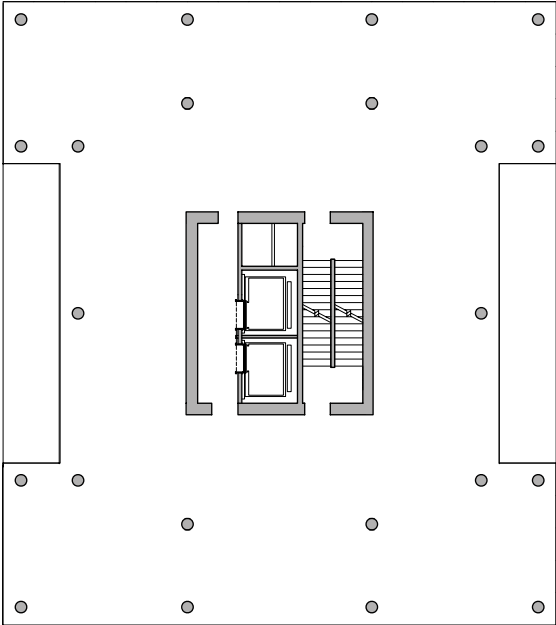

12, 20, 30 storeys in height  
Concrete structure  
Refer to Appendix A for structural details

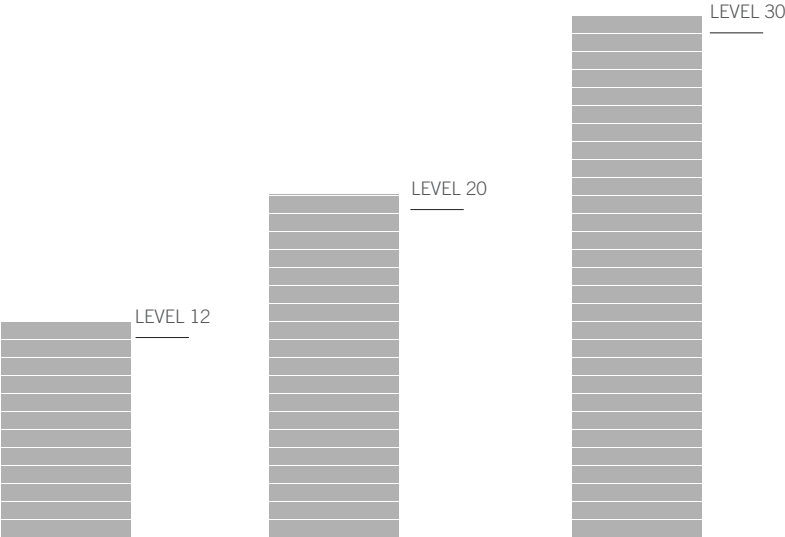

**Building heights**

# Concrete Tower Benchmark

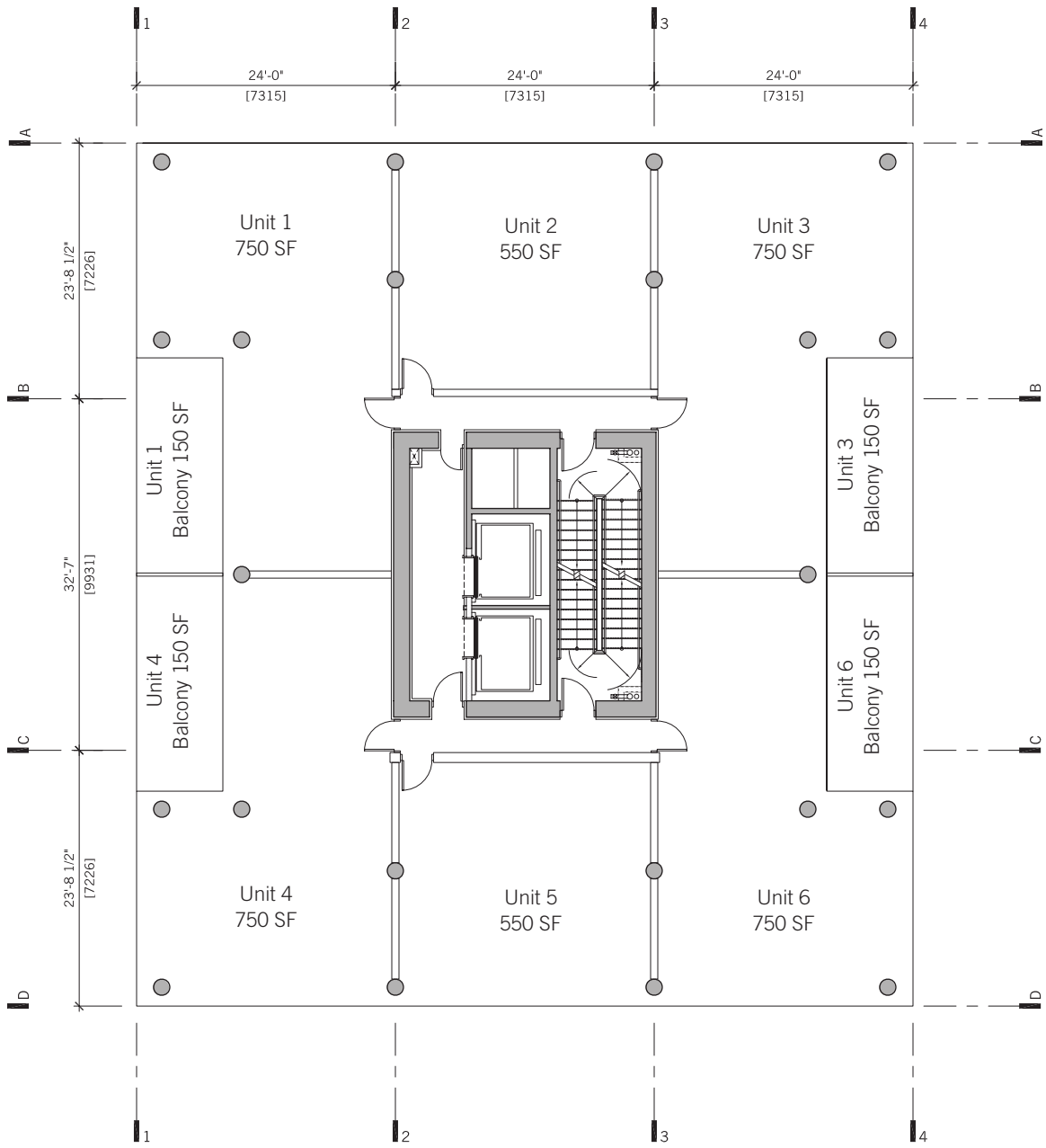

12, 20, 30 storeys in height  
 Concrete structure  
 Refer to Appendix A for structural details

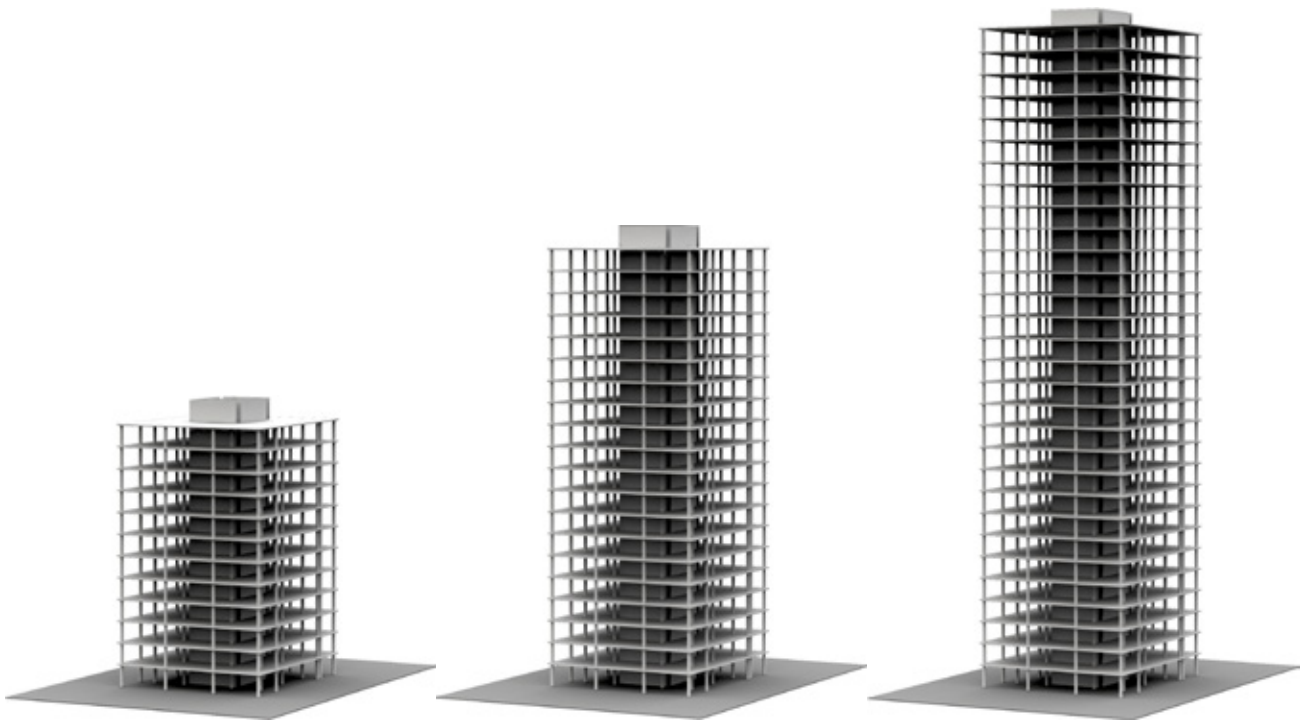

12, 20, 30 storeys in height  
Concrete structure  
Refer to Appendix A for structural details

### 3.4 Proposed Tower Solutions - Applied and Theoretical Plans

#### FFTT Structural Diagrams

The following diagrams illustrate 4 possible structural configurations utilizing the FFTT system. With each option, the structural capacity principally determines the possible building heights. For instance, in Option 1, a building height up to 12 storeys is achievable employing structural core walls and glulam columns at the perimeter as the supporting structure. In options

2 and 3, which achieve greater building heights up to 20 storeys, additional structure is required. Structural interior walls and structural exterior walls provide this additional support in options 2 and 3 respectively. For option 4, as in option 2 and 3, structural interior walls and structural exterior walls provide additional support.

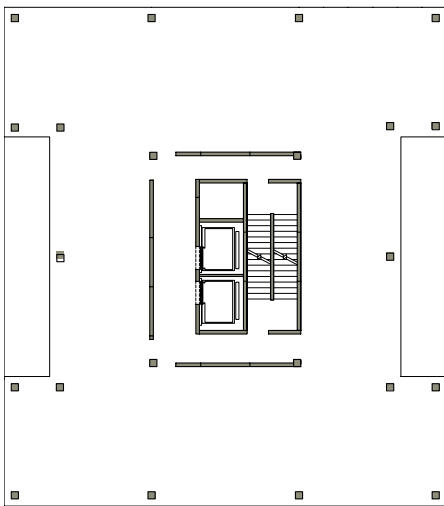

OPTION 1  
Up to 12 storeys in height  
Structural core  
Glulam columns at curtain wall

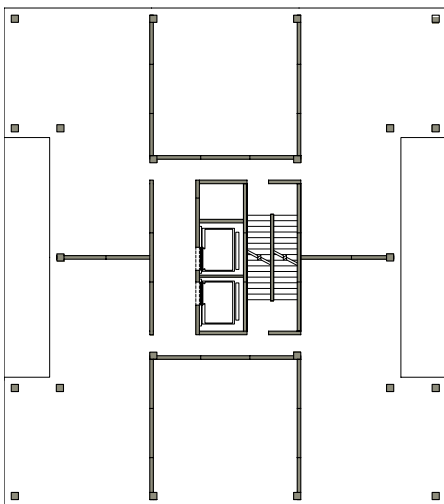
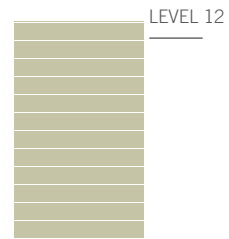

OPTION 2  
Up to 20 storeys in height  
Structural core and interior walls  
Glulam columns at curtain wall

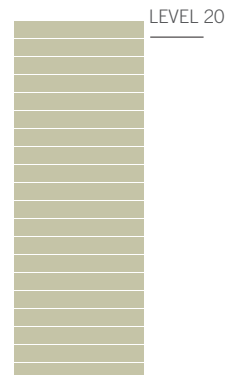

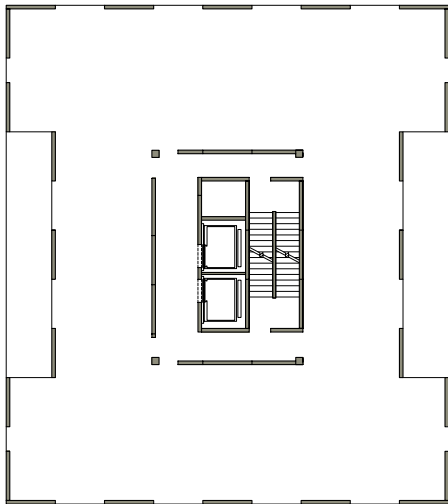

OPTION 3  
Up to 20 storeys in height  
Structural core and exterior walls

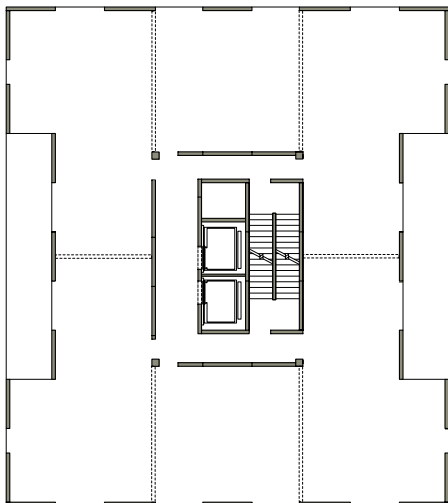
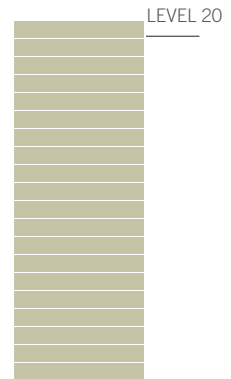

OPTION 4  
Up to 30 storeys in height  
Structural core, interior walls or  
exterior walls

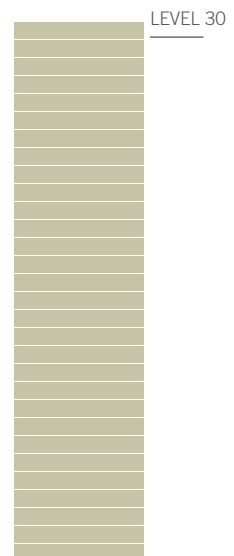



## FFT Axonometric Diagrams

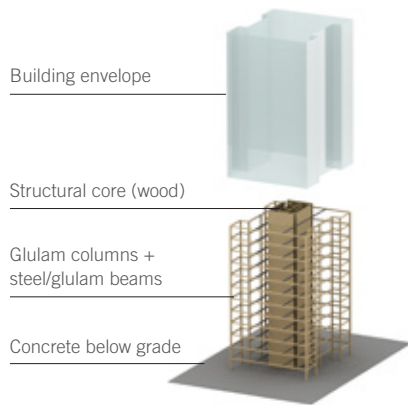

**OPTION 1** - Up to 12 Storeys

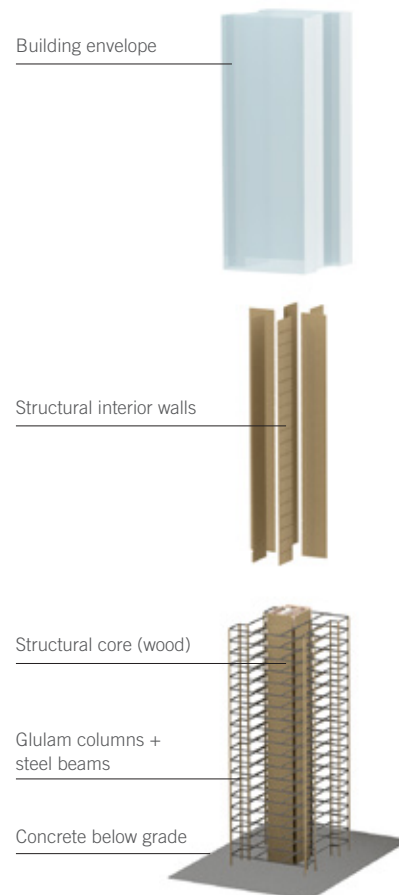

**OPTION 2** - Up to 20 Storeys

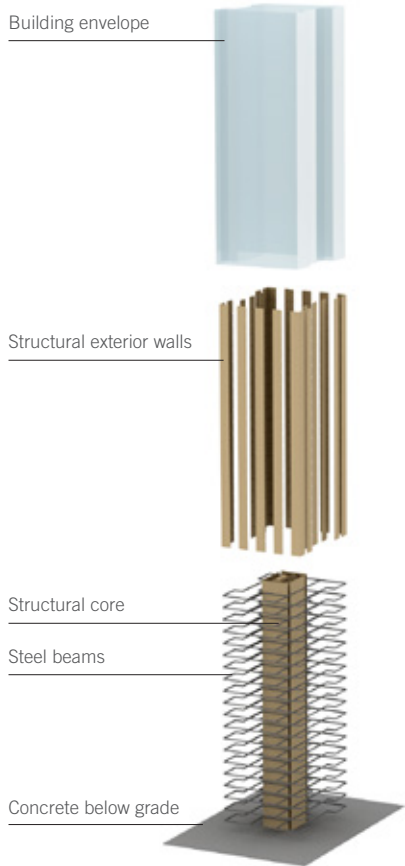

**OPTION 3** - Up to 20 Storeys

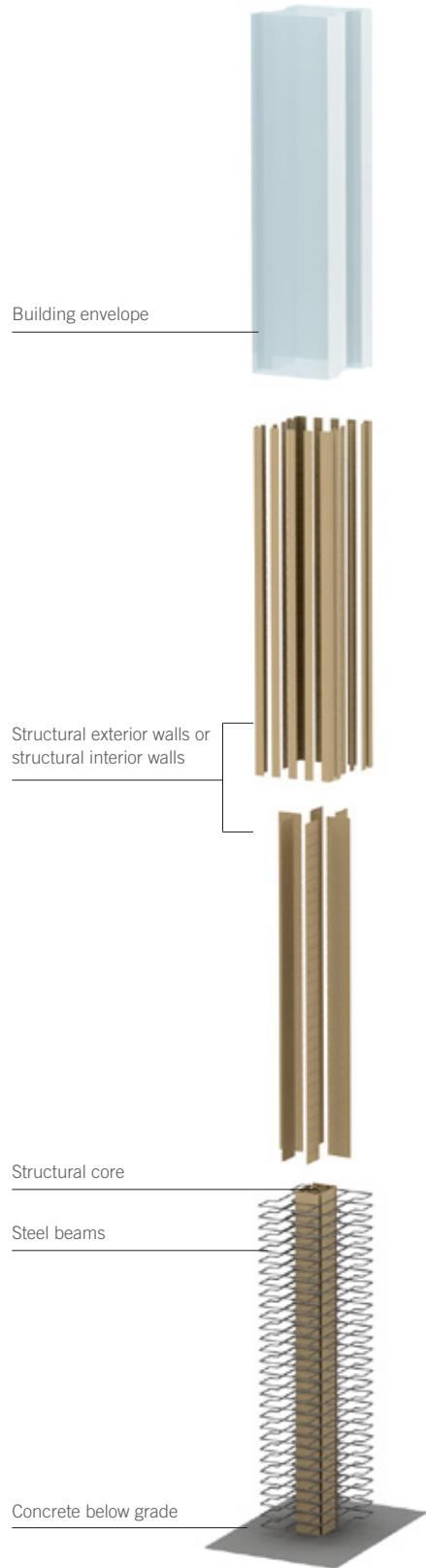

**OPTION 4** - Up to 30 Storeys

### Implied Architectural Impact as Result of the Structure

The structural configurations, in addition to determining the achievable building heights will impact both the design of the envelope and floor plan of the building. For example, Option 1 offers the greatest amount of flexibility in the design of its interior partitioning. This structural configuration bears closest resemblance to the typical concrete benchmark in that it utilizes a structural core and perimeter columns that affords it a free-plan. In options 3 and 4, where additional structure is required for the increase in building height, constraints are placed on the design of either the interior partitions or envelope. As a result, these configurations can be more advantageously applied to specific uses. For instance, where interior walls are utilized as structure, a residential application would be appropriate where these structural walls could double as unit demising walls.



**OPTION 1** - Up to 12 Storeys



**OPTION 2** - Up to 20 Storeys

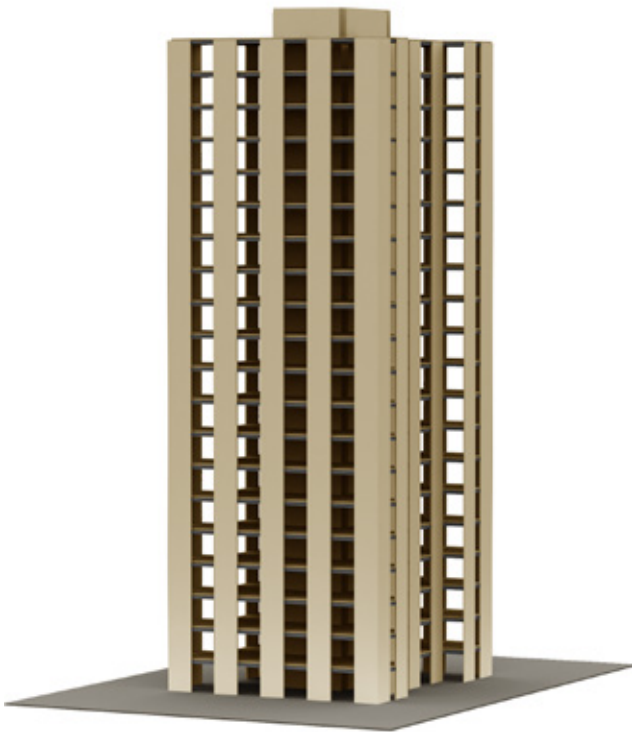

**OPTION 3** - Up to 20 Storeys

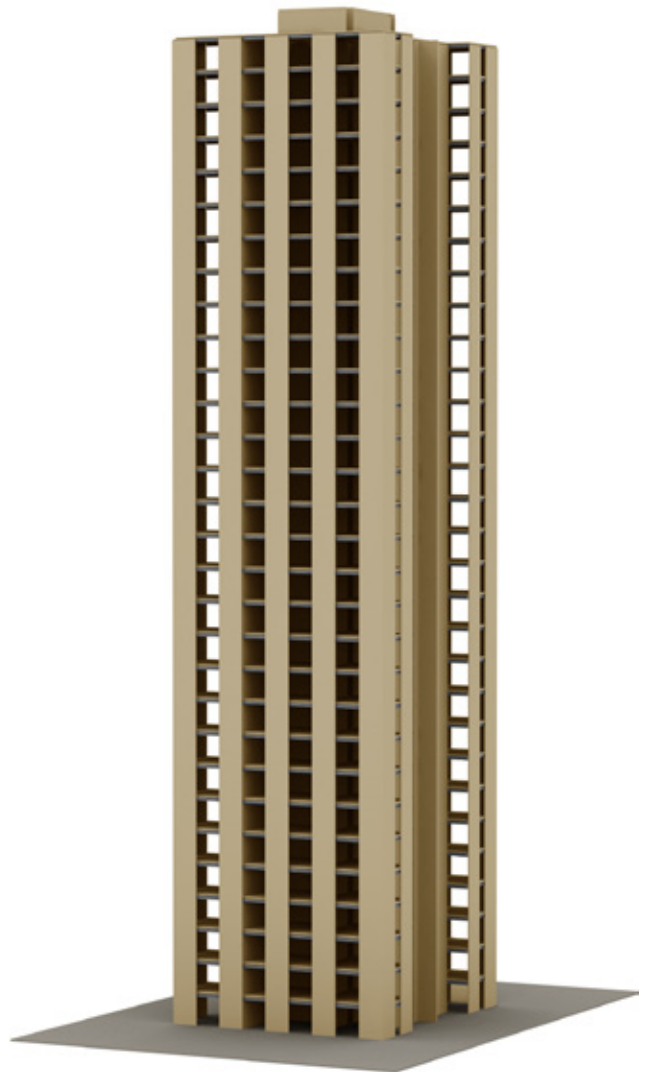

**OPTION 4** - Up to 30 Storeys

### CASE STUDY - OPTION 1

Up to 12 storeys in height  
Structural core  
Glulam columns at curtain wall

In this option, which allows up to 12 storeys in building height, the wood core walls and glulam perimeter columns are deployed as the supporting structure. Since none of the interior walls are required to have a load bearing function, a great amount of flexibility is afforded in terms of floor plan layout. As well, in the absence of exterior load bearing walls, this option allows flexibility in the design of its façade, including the ability to support an entire curtain wall envelope if desired.

Additionally, like many buildings with such open spaces, interior modifications are easily made to allow for future changes in occupancy or use. Its open floor plan and ability to easily accommodate future changes positions this option quite competitively in terms of use and planning to its concrete benchmark, particularly in the office market.

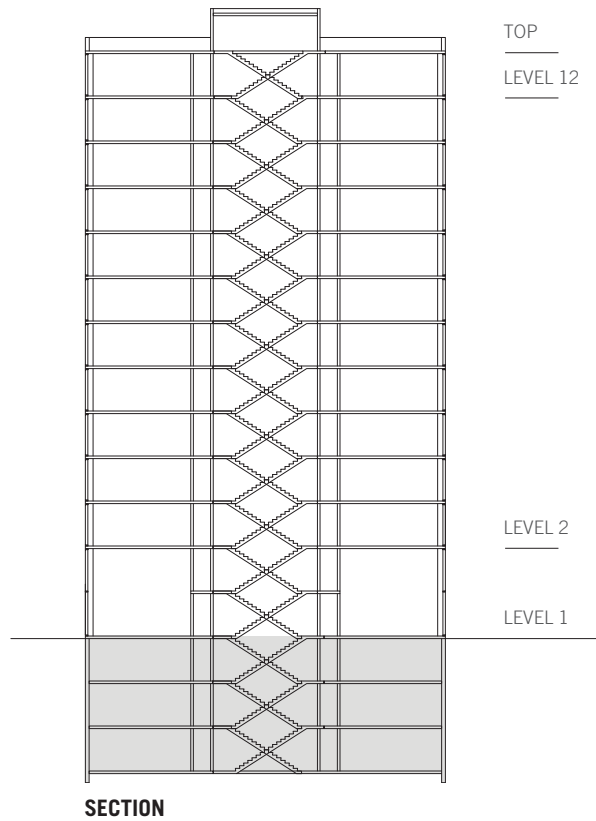

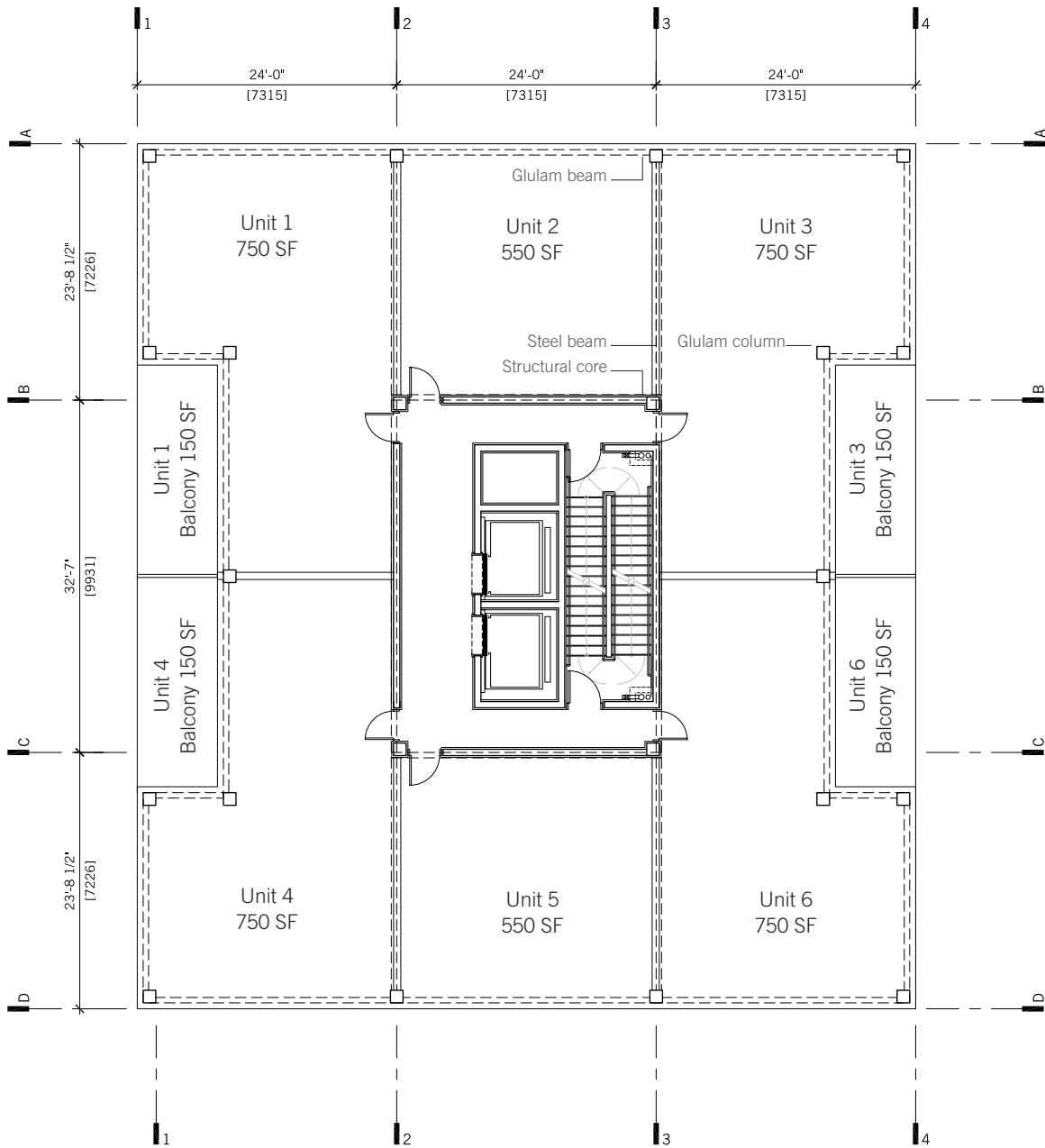

**PLAN**

Refer to Section 3.6 Structural Intent for structural information

## CASE STUDY - OPTION 2

Up to 20 storeys in height  
Structural core and interior walls  
Glulam columns at curtain wall

Here, in addition to the structural wood core walls and glulam perimeter columns, interior structural walls are introduced in order to increase the possible building height up to 20 Storeys. Similarly to Option 1, in the absence of exterior structural walls, this option also allows great flexibility in the design of its facade, supporting an entire curtain wall if desired. In terms of interior planning, the introduction of interior load bearing walls diminishes some flexibility in floor plan layout and future changes as optimized in Option 1. However, these interior structural walls can be located accordingly, for specific uses such as demising walls between units.

This structure lends itself to being more suitable for a residential application, as it does not offer the open plans desirable of office layouts. However, because of its structure, it offers a competitive building height, pushing it from a mid-rise to a high-rise structure.

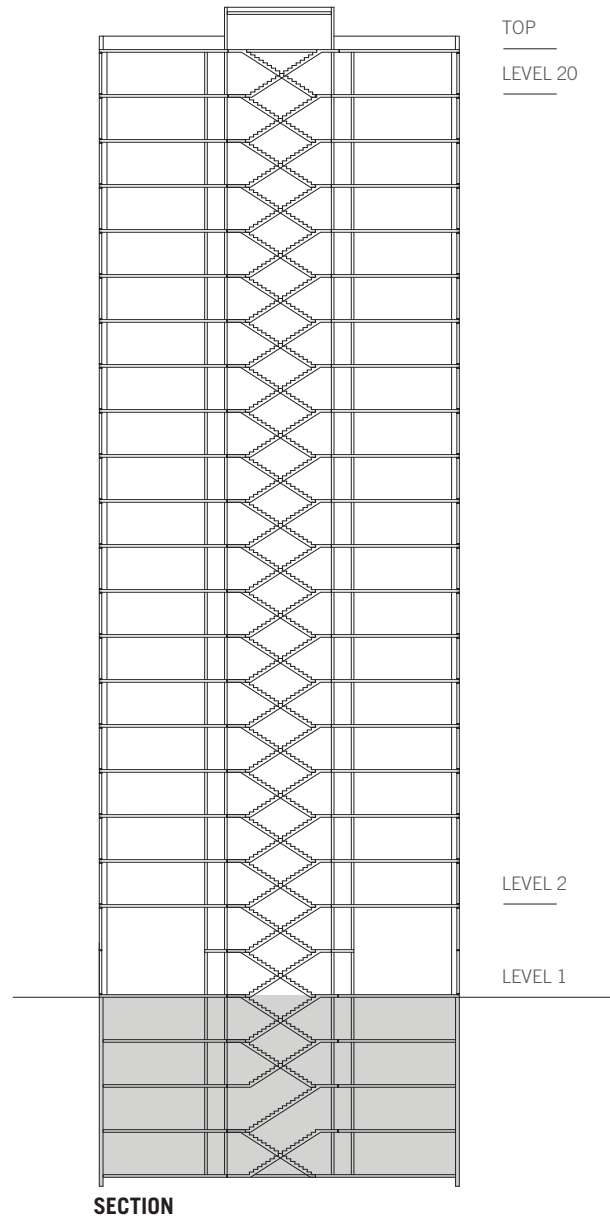

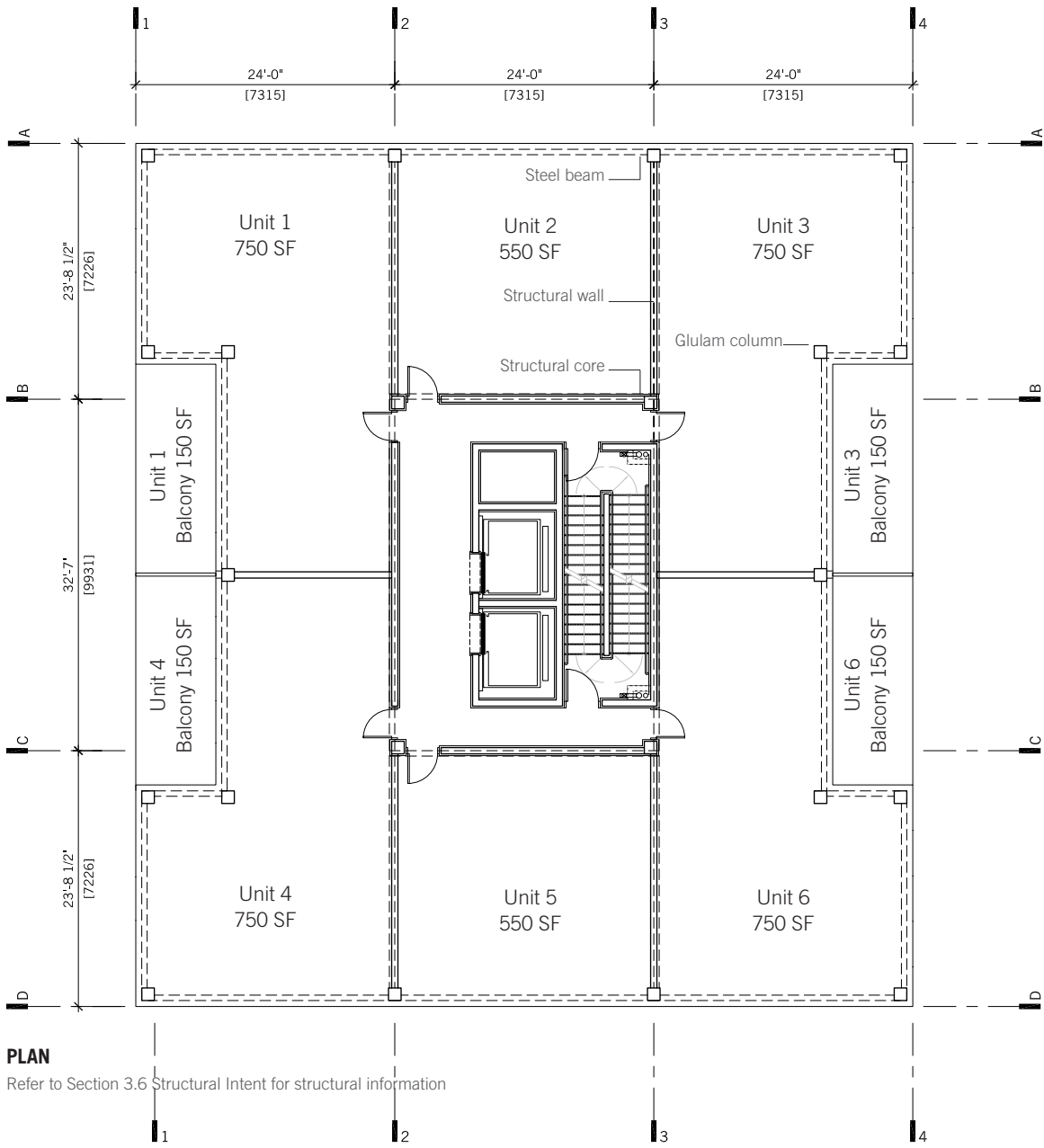

**PLAN**

Refer to Section 3.6 Structural Intent for structural information



### CASE STUDY - OPTION 3

Up to 20 storeys in height  
Structural core and exterior walls

This option is similar to Option 2, with a maximum achievable building height of 20 storeys. This is accomplished utilizing structural wood core walls and introducing exterior structural wood walls. Here, the exterior structural walls have replaced the interior structural walls and perimeter glulam columns in Option 2.

The impact of this is that the plan is now structure free, again allowing flexibility in terms of interior partitioning and allowing future interior modifications. On the other hand, the presence of the exterior structural walls now limits the flexibility of the facade. For example, where solid structural walls occur, it would not be possible to have vision glass. As result of this structure, punched or bay windows would be most suitable. Additionally, from a thermal performance point, these exterior walls provide opportunities for greater insulating assemblies.

This structure would be particularly suitable for residential applications in consideration of its exterior structure and facade composition. While, its open interior plan would be suitable for an office arrangement, it would be challenged in the office market because of its obstructed views and amount of daylight the interior receives relative to its concrete benchmark which can utilize a completely glazed curtain wall. Again, like Option 2, it offers a competitive building height at 20 storeys.

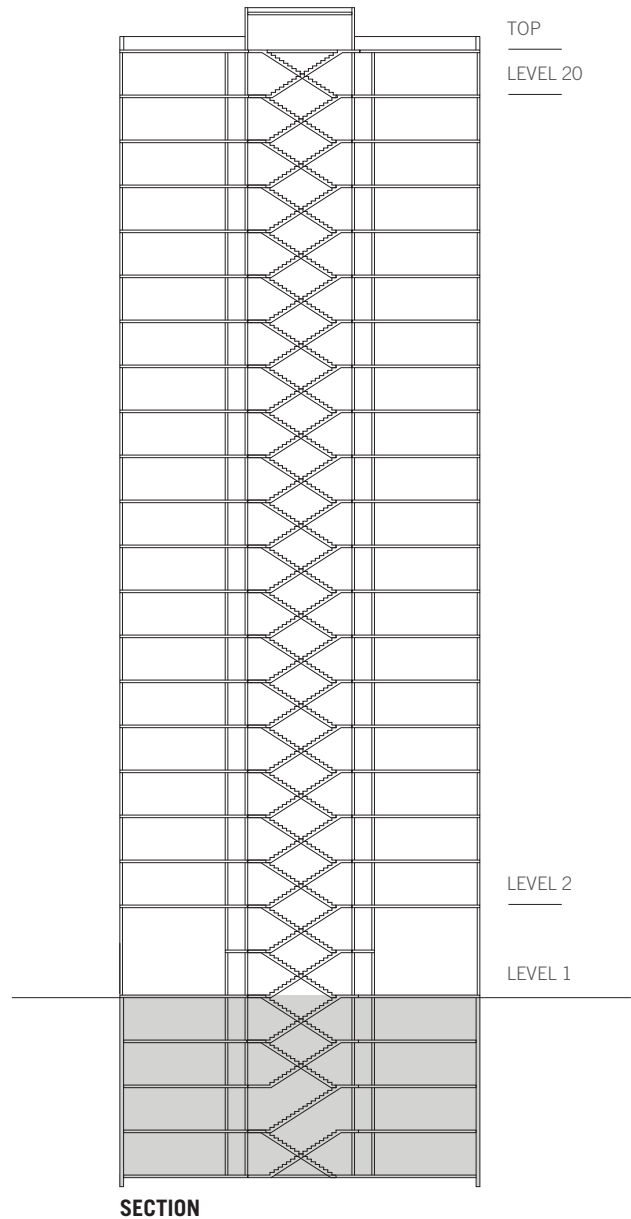

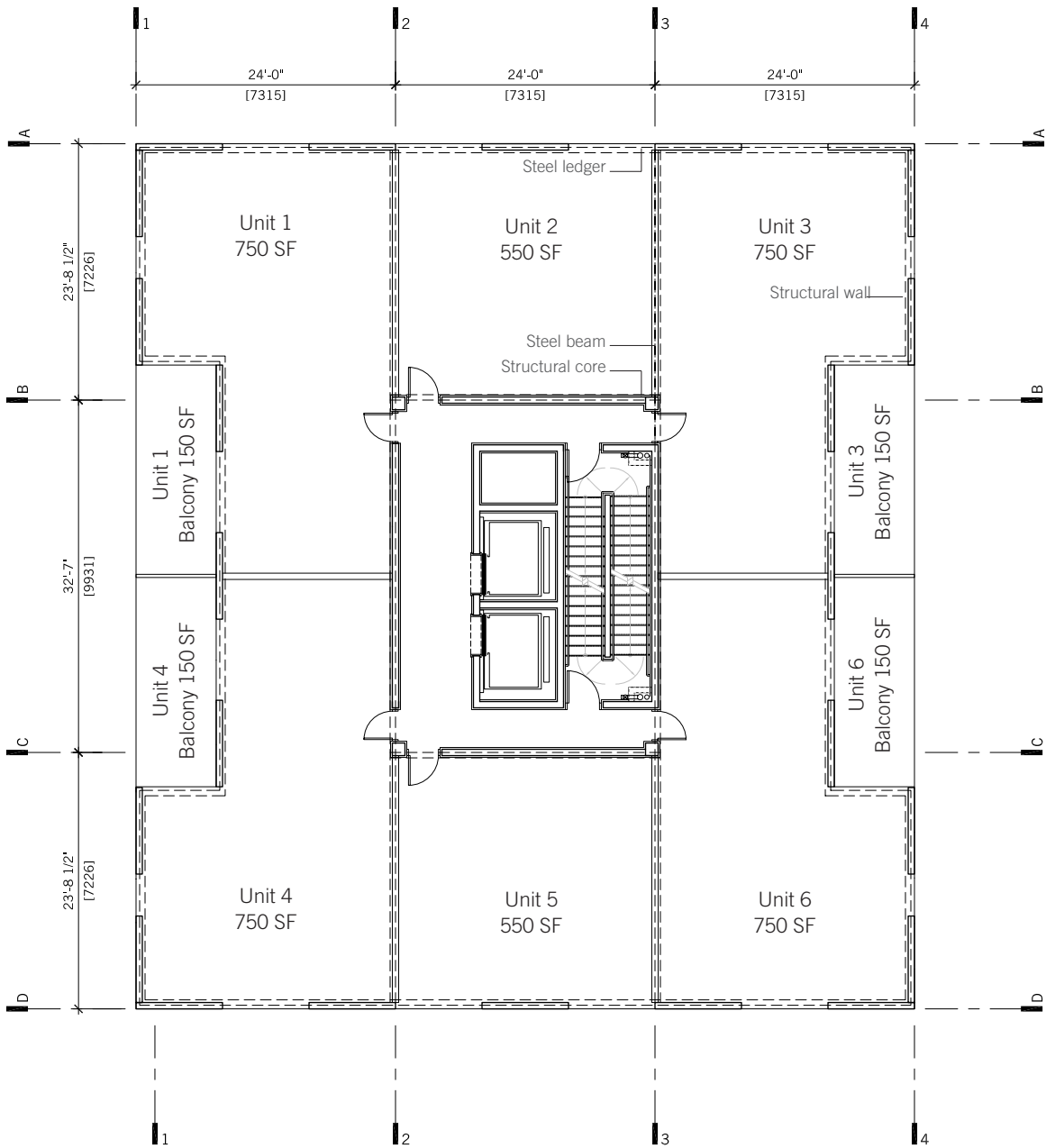

**PLAN**

Refer to Section 3.6 Structural Intent for structural information

Note: Our analysis has shown that a 30 storey model performed adequately with either the interior partition walls or perimeter frame.

#### CASE STUDY - OPTION 4

Up to 30 storeys in height  
Structural core, interior walls and exterior walls

This option pushes the maximum building height to 30 storeys. To do so, it utilizes structural core walls, structural interior walls and structural exterior walls. As a result, it offers the least flexibility of the four options. Its interior structural walls would limit it to residential use, as in Option 2, its exterior structural walls would limit the envelope options as discussed in earlier in Option 3.

The primary advantage of this option is its building height. However, the structure that is required to achieve this height becomes disadvantageous to its planning and design flexibility. As a result, this option is limited in its flexibility and use.

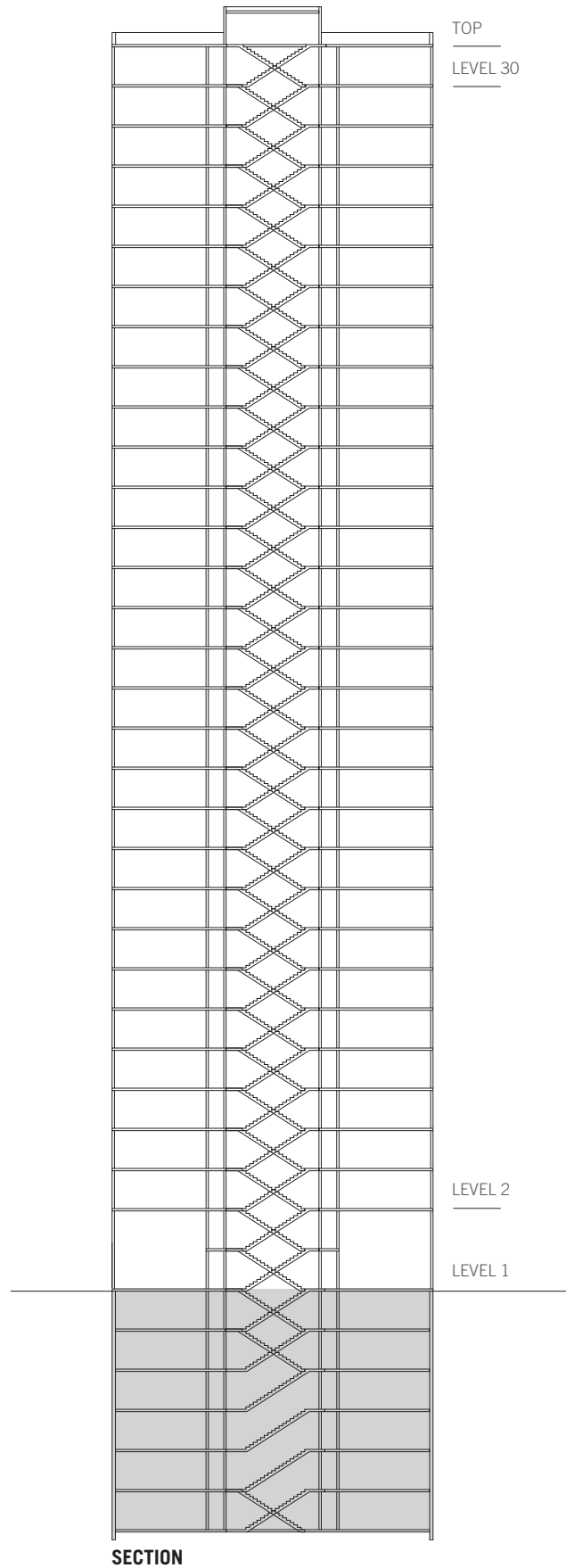

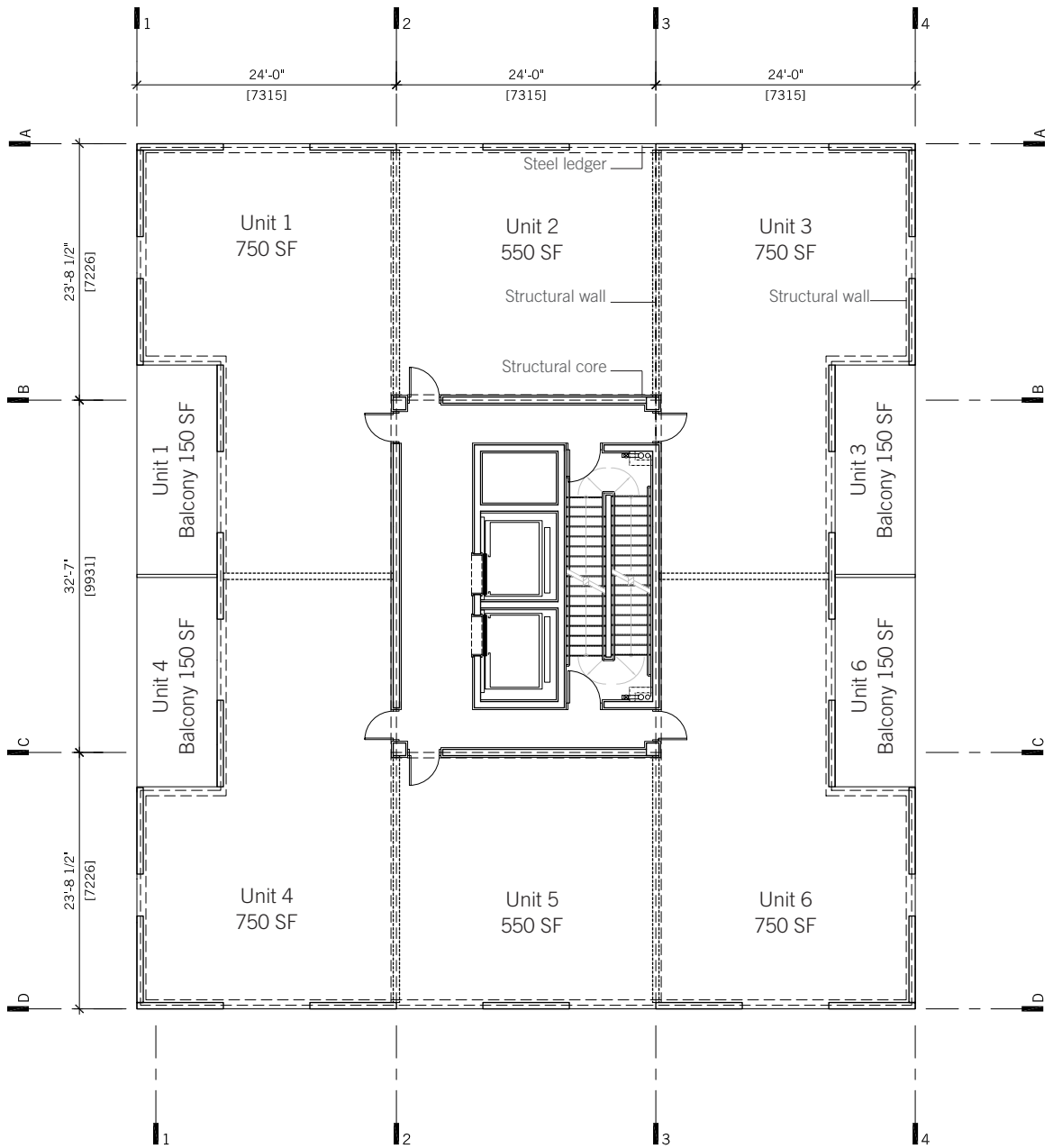

**PLAN**

Refer to Section 3.6 Structural Intent for structural information.

Note: Our analysis has shown a 30 storey model performed adequately with either the interior partition walls or exterior frame

### 3.5 Architectural Application of an Idea

The FFTT system is designed and considered as a universal structural system to engineer tall wood buildings. However, it is important to understand that it has also been driven by a number of architectural issues pertinent to tall buildings that are crucial to the system's success. The FFTT system allows for flexibility in tower planning and facade design with some decrease in flexibility once the system is utilized in applications above 20 storeys. Above this height, an FFTT tower would likely be limited to residential use. The flexibility in tower planning is important for a number of reasons:

1. An open plan (where there are no interior structural partition walls) allows for a variety of uses including office or residential.
2. An open plan (where there are no interior structural partition walls) allows for future modifications as uses and tenants change.
3. Developers typically look to flexibility in the structural system to ensure they can manipulate the solution to meet their market goals. Open plans give enormous design flexibility to the developers and architects.
4. Exterior character and massing are important to adjust to the specifics of a given site, setback requirements, views and view corridors, shadowing conditions or architectural expression.

In addition to these considerations, a review of acoustic and vibration conditions, systems integration, life safety, fire and finishing relevant to tower construction follow in subsequent sections. In summary, what we have found is that there are no obstacles with FFTT to satisfying the typical needs of a tower design leaving possibilities open to the imagination of all architects.

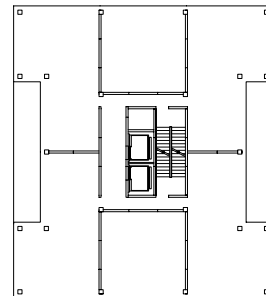
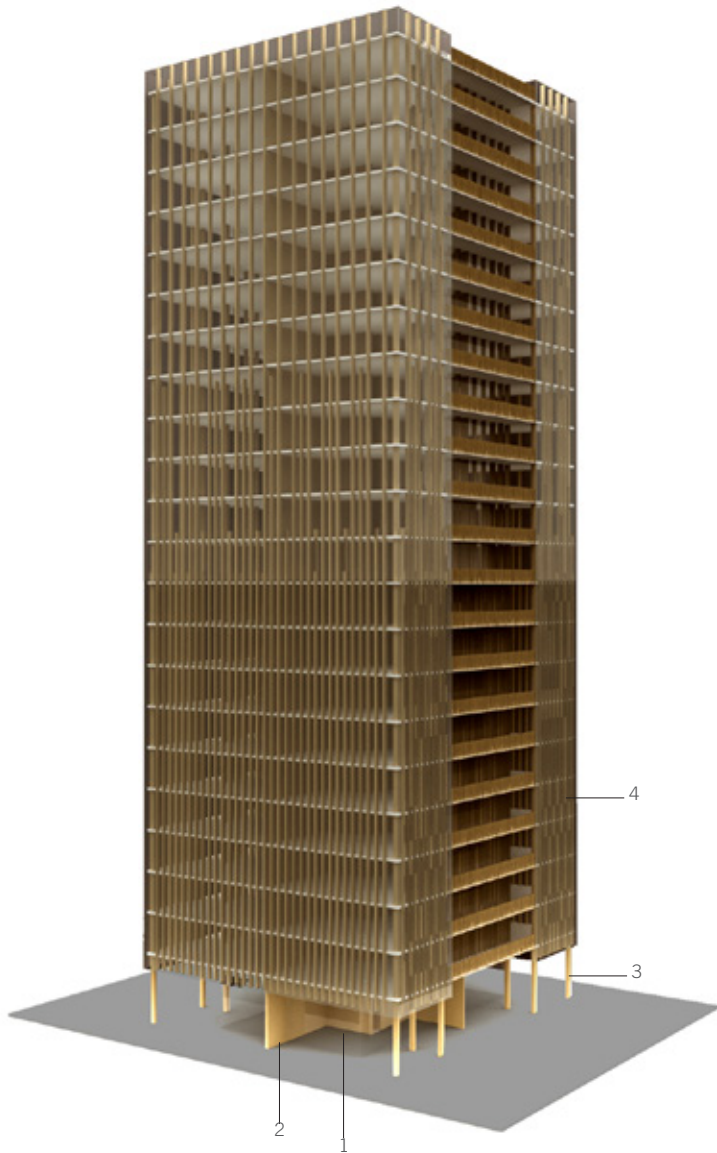

**OPTION 2 - Illustrated with a glulam curtain wall**

- 1 Structural core
- 2 Structural unit partition walls
- 3 Glulam columns
- 4 Protective envelope

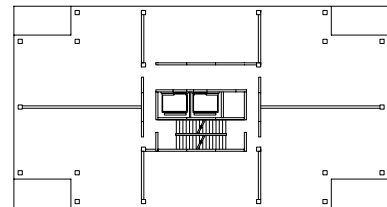

**OPTION 2 - Illustrated with a glulam curtain wall and corner balconies**

- 1 Structural core
- 2 Structural unit partition walls
- 3 Glulam columns
- 4 Protective envelope
- 5 Corner balcony



Interior perspective illustrating a glulam curtain wall



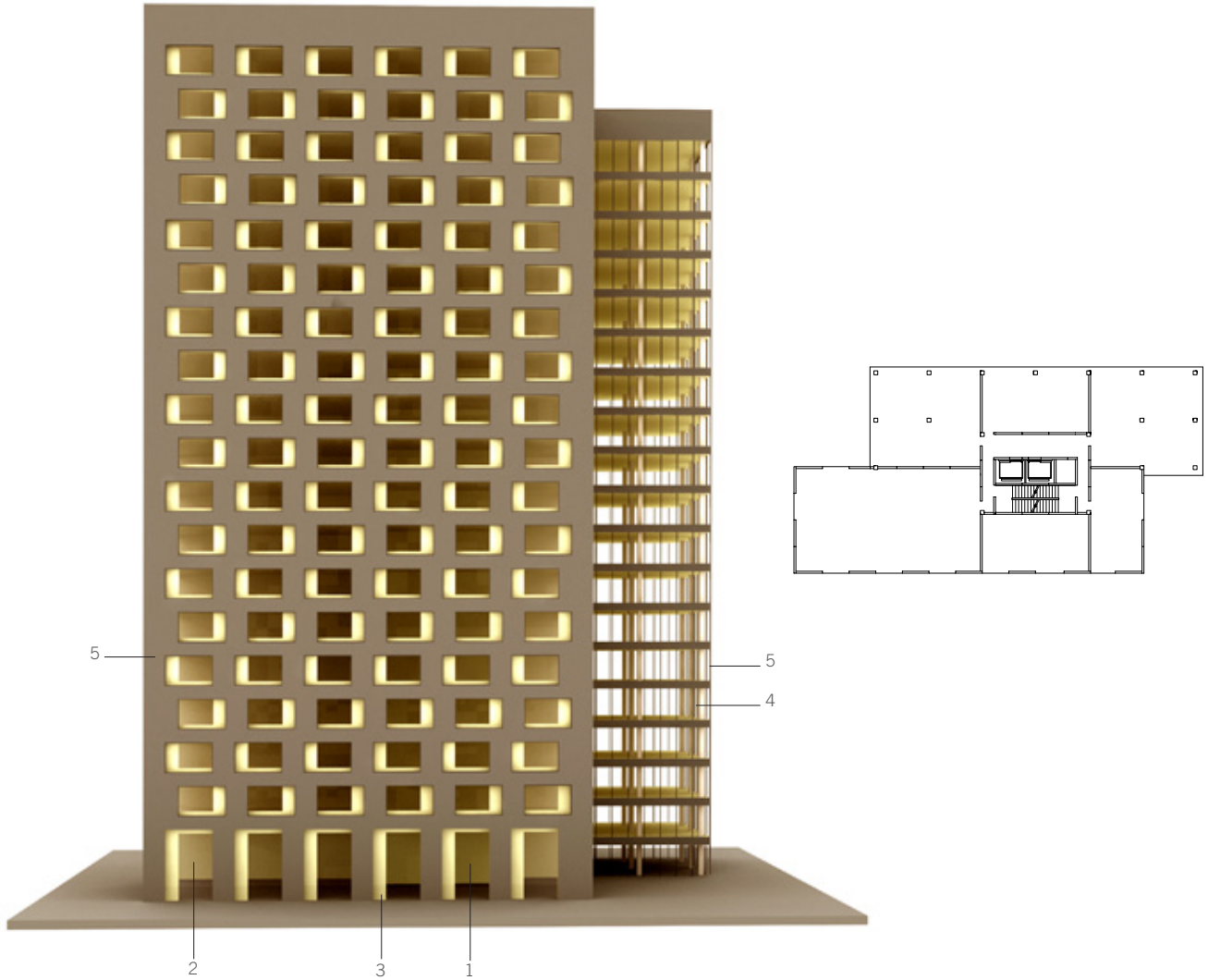

**OPTION 2 + 3 Hybrid - Illustrated with punched windows and a curtain wall**

- 1 Structural core
- 2 Structural unit partition walls
- 3 Structural exterior walls
- 4 Glulam columns
- 5 Protective envelope



Interior perspective illustrating structure as finishing

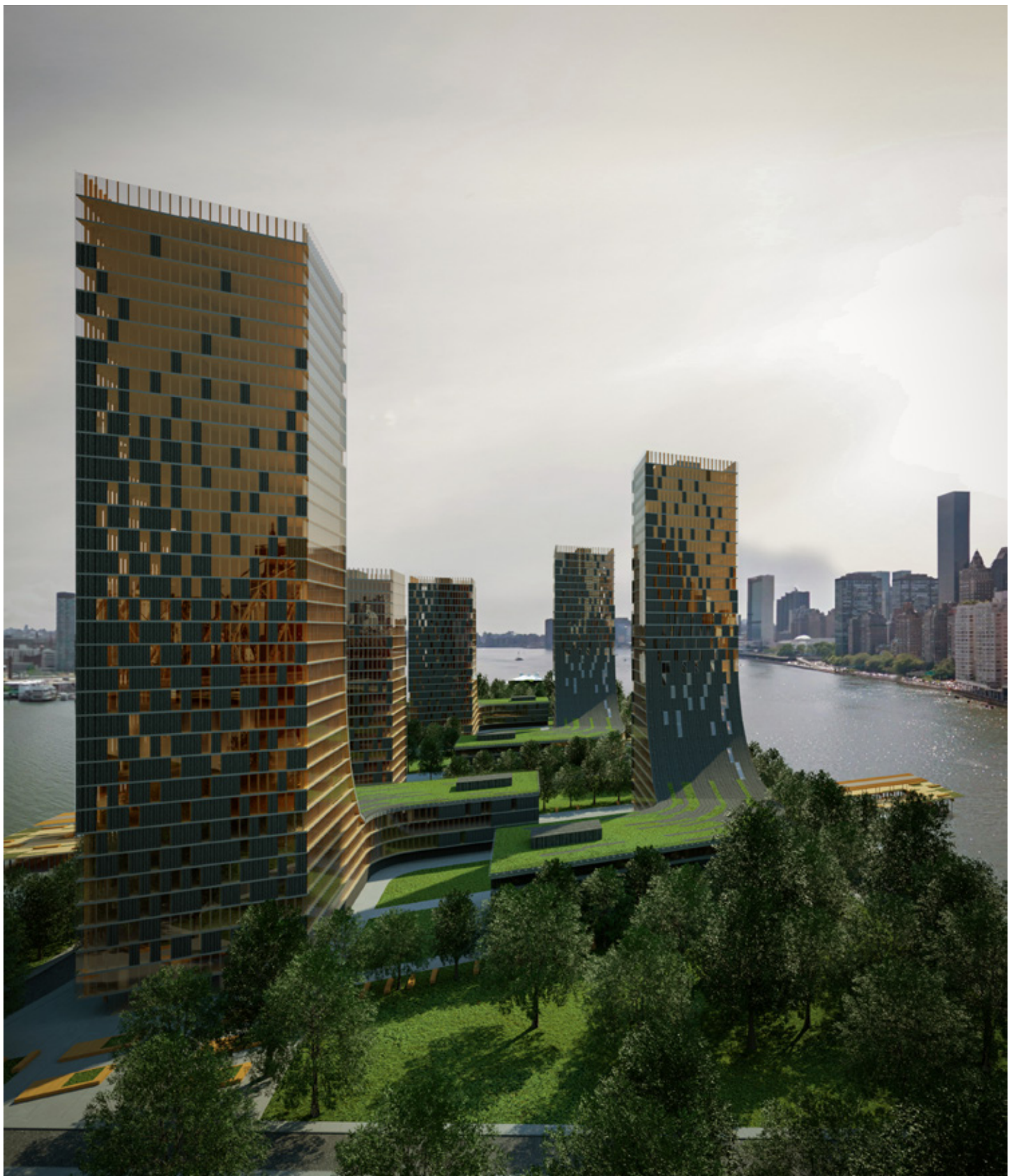

**Option 2 illustrated with a glulam curtain wall and podium base**

image: MICHAEL GREEN ARCHITECTURE



## 3.6 Structural Intent

### Introduction

The history of tall wood structures is 15 centuries old or more. The Horyu-ji temple in Japan, a post and beam timber structure dating back to the 7th century, still stands today at 32.5 metres in height in one of the highest seismic zones in the world.

The shift from heavy timber to light wood frame construction over the past century has triggered a natural progression towards lower wood structures. It is not wood as a material that prompted this shift, but the inherent limitations of light wood frame as a construction system. Light wood frame, while economical and versatile, is much more vulnerable to fire and less sturdy than heavy timber construction. Our own Canadian record of century-old post and beam buildings that dwarf today's light wood frame is a testament to the natural strength and resilience of wood as a structural material.

The recent adoption of 6 storey wood construction in the BC Building Code only constitutes progress in the context of light wood frame construction. In the larger context of heavy timber and engineered wood construction, the limits of scale and height potentially lie an order of magnitude beyond. The introduction of solid engineered wood panel products to our market offers the possibility to achieve this untapped potential. Structurally, one would think we should ultimately be able to build timber structures that are at least as tall as the trees that grace the forests of our beautiful province.

This report clearly builds on the efforts of other designers around the world. We hope our work makes a contribution to the overall effort, and look forward to others building upon the concepts presented herein.

### Scope

The following is a case study exploration of the performance of an innovative structural solution as it applies to the construction of a typical 12, 20 and 30-storey residential tower in Vancouver, British Columbia. The proposed system consists of large engineered wood wall and floor panels such as CLT, LSL or LVL panels, linked together with ductile wide flange steel beams, designed to yield and provide plastic hinges in a seismic event.

The specifics of our model are based on an arbitrary residential solution, however the concepts would be equally applicable to high-rise office construction or the construction of large-scale, low-rise buildings such as airports, museums or commercial complexes. The study presents a structural system which we believe makes the design of truly large scale timber structures

technically possible, whether they reach high towards the sky or wide across the horizon. But it also aims to present a construction system that is simple, flexible and economically viable.

While the study included preliminary calculations and computer modelling, the results remain primarily conceptual in nature. More detailed analysis as well as laboratory testing will be required to advance this effort to the implementation stage.

### Solid Wood Panel Construction

Widely used in Europe, particularly in low-energy construction, solid wood panels are dubbed the “concrete of the 21st Century”. Solid wood construction refers to all solid wood panel types, including side and cross-laminated panels - glued, dowelled or nailed. In the North-American context, they also include engineered wood panel products such as LSL and LVL, which are originally produced in large billets and subsequently cut into smaller elements.

One particular panel type, called CLT's (Cross Laminated Timber), the glued type, has recently attracted a lot of attention in Canada. Three Canadian Universities as well as FPInnovations (the largest timber research organization in the world) have been carrying out significant research in Vancouver and Québec City on CLT's over the last five years. This research has been aimed at numerous aspects of CLT design and construction, including fabrication and quality control, mechanical properties, seismic behaviour and connections, vibration and sound transmission, environmental impact and cost comparisons.

A joint Canada-US task force is due to release a CLT production standard by this summer. The first North-American CLT conference took place in Vancouver at which FPInnovations' excellent CLT design handbook was released. Most significantly, three Canadian timber suppliers have entered the market this year with their own brand of CLT panel products.

Qualifying as heavy timber under the current BC Building Code, solid wood panels display many of the qualities found in cast-in-place concrete construction, including strength and stiffness, good thermal mass, soundproofing and vibration control, and good fire resistance. In addition, solid wood panels offer a lighter and economical alternative to concrete construction and faster erection due to CNC pre-fabrication, with all the environmental and architectural qualities we know about wood, including a reduction in the carbon footprint embodied in the building.

For the purposes of this study, two basic panel types have been considered: Glued CLT's and LSL (Laminated Strand Lumber) panels. While LVL (Laminated Veneer Lumber) panels have not been reviewed specifically, they have similar characteristics to LSL panels and could also be used.

Glued CLT panels are now available from Canadian suppliers in sizes up to 400mm thick, 3m wide and 13m long. LSL and LVL are produced in Canada in billets up to 89mm thick, 2.44m wide and 19.5m long.

### Can Solid Timber Panel Construction Go Tall?

A building structure consists of individual elements connected together to form a system. The first step in assessing this system, is the assessment of the material proposed for the fabrication of its components. All other issues set aside (connections, ductility, erection, weather protection etc.) does engineered wood in itself have the inherent strength required to practically reach 30 storeys or more?

We know high-rises can efficiently be built of reinforced concrete. Let's then compare the properties of LSL and CLT wood panels, with the properties of the typical reinforced concrete core walls shown in our base case in Appendix A. For this purpose, we have transformed all basic properties of the reinforced concrete walls, LSL and CLT panels into comparable units of stress, based on gross cross sectional area.

To achieve comparative values for concrete, approximate gross equivalent stresses using the combined contribution of the reinforcing and concrete (equivalent areas) have been calculated, using 35MPa concrete and the steel reinforcing areas shown in our base case shear wall. The effective modulus of elasticity has been derived from the simplified assumption that the effective stiffness of a cracked reinforced concrete wall is roughly equal to 30% of the gross sectional stiffness ( $E_{cl} = 0.3 E_{c, gross}$ ).

Average factored capacity	Concrete	LSL (1.5E)	CLT
	(MPa)	(MPa)	(MPa)
Compression (vertical direction)	±20.0	21.5	±14.0
Tension (vertical direction)	± 6.0	19.1	± 9.0
Flexure (in plane)	± 6.0	± 9.0	28.7
Flexure (out of plane)	± 5.0	32.2	±18.0
Shear (in wall plane)	± 2.0	5.2	± 3.0
Modulus of elasticity	10,000	10,345	± 6,000

The values for CLT vary with material species and grade as well as with layer makeup. The following values have been estimated using D-Fir No1 material on the outer layer, D-Fir No 3 material for the core layers and a 60% longitudinal plank ratio. As the Canadian CLT industry grows, a greater variety of plank thicknesses, grades and species should become available, as was the case in Europe, allowing for more flexibility and efficiency in panel design.

It is clear that much stronger concrete can be achieved. The purpose of this exercise is not to show that one material is stronger than the other but to demonstrate that, based on the inherent strength of materials alone, if one can build a 30-storey concrete building with 35 MPa reinforced concrete, one should be able to also do so in solid wood panels. Considering that timber weighs a quarter of the weight of reinforced concrete, resulting in much lower gravity and seismic loads on the structure, one would also think, based on the table above, that solid wood panel construction should be able to do the job quite efficiently.

Structurally, the challenge then resides in the ability to achieve efficient and reliable connections and develop systems with sufficient ductility to achieve good performance in high seismic zones. We believe this report presents workable solutions addressing these issues. As more work is done and more minds focus their attention on this potential new way to build, more solutions will emerge, making tall timber construction increasingly efficient and competitive.

### CLT vs LSL (or LVL) panels

You will note that CLT and LSL panels have been used interchangeably in the typical details and discussions throughout the report. While the use of one panel type over the other will of course have an impact on specific details of a design, our analysis has shown that it does not have a significant impact on the overall dimensioning of the lateral load resisting system and floor panel.

For the purposes of this report, which aims to be primarily conceptual in nature, element sizes were often matched to the closest panel thickness currently available in the in the Canadian market. Shear wall thicknesses for instance were increased in increments of 3 ½ inches to match the thickest common LSL panel thicknesses available. More refined and efficient dimensioning would of course be considered in an actual design and will become increasingly possible as the industry sees the market potential of panel products and offers a larger variety of panel dimensions.

## Design Data

The following design values are based on Appendix C of the British Columbia Building Code 2006 for Vancouver. This data constituted the basis of our preliminary design. See right chart.

Based on BCBC 2006 and the Canadian Standards Association codes for material design (latest editions).

## Code Analysis

Based on BCBC 2006 and the Canadian Standards Association codes for material design (latest editions).

At the beginning of the study, we opted to look at four case study options, based on the typical residential tower floor layout provided by the architect and various building heights (see architectural report). These consist of:

- › Option 1: 12 Storey building with core only
- › Option 2: 20 Storey building with core and interior shear walls
- › Option 3: 20 Storey building with core and perimeter moment frames
- › Option 4: 30 Storey building with core and perimeter moment frames and interior walls

Structural concept plans have been included for each option below, and the associated architectural floor plans, elevations and exploded 3D models can be found in the architectural report.

While we originally anticipated that both interior shear walls and perimeter frames would be required to achieve sufficient stiffness for the 30-storey case (Option D), we discovered in the end that this was not the case, and that Options B and C both performed comfortably well for 30 storeys or more.

The structural options we have chosen are for demonstration purposes. Numerous other arrangements are certainly possible and may be required for different building geometries and sizes. The intent is to demonstrate that the innovative concepts of lateral load resisting systems in solid wood construction that we are proposing do meet the requirements of the code for various building heights, and display good reliable ductile behaviour under seismic loading. These concepts, we believe, provide a new workable structural solution for buildings of all types and sizes.

Please refer to Appendix A for the preliminary analysis results of our study for the four different options. These have been compared to concrete structures of equal height and identical floor plan. Also refer to Appendix A for typical details and reinforcing requirements for the concrete options.

Importance Category	Normal
Climatic Design Data (per BCBC 2006)	
ULS importance factor for snow	IC = 1.00
Ground Snow Load	IS = 1.60 kPa SS = 0.30 kPa Plus snow built up where applicable
ULS importance factor for wind	I <sub>w</sub> = 1.00
Hourly Wind Pressure	(1/10) 0.38 kPa
Hourly Wind Pressure	(1/50) 0.48 kPa
Seismic Design Data	
ULS importance factor for earthquakes	I <sub>q</sub> = 1.00
5% damped spectral accelerations	Sa(0.2) = 0.88 Sa(0.5) = 0.61 Sa(1.0) = 0.33 Sa(2.0) = 0.17
Peaked ground acceleration	PGA = 0.44
Assumed Site Class	C
R <sub>d</sub> (Based on FPIInnovation seismic tests)	2.0
R <sub>o</sub> (Based on FPIInnovation seismic tests)	1.5
R <sub>d</sub> (moderately ductile moment frames)	3.5
R <sub>o</sub> (moderately ductile moment frames)	1.5
Design Live Loads	
All floor and patio areas	1.90 kPa
Roofs	1.58 kPa Plus snow built up where applicable
Lateral Interstorey Drift Limit	
Wind	h <sub>n</sub> /500
Seismic	h <sub>n</sub> /40

# Plans



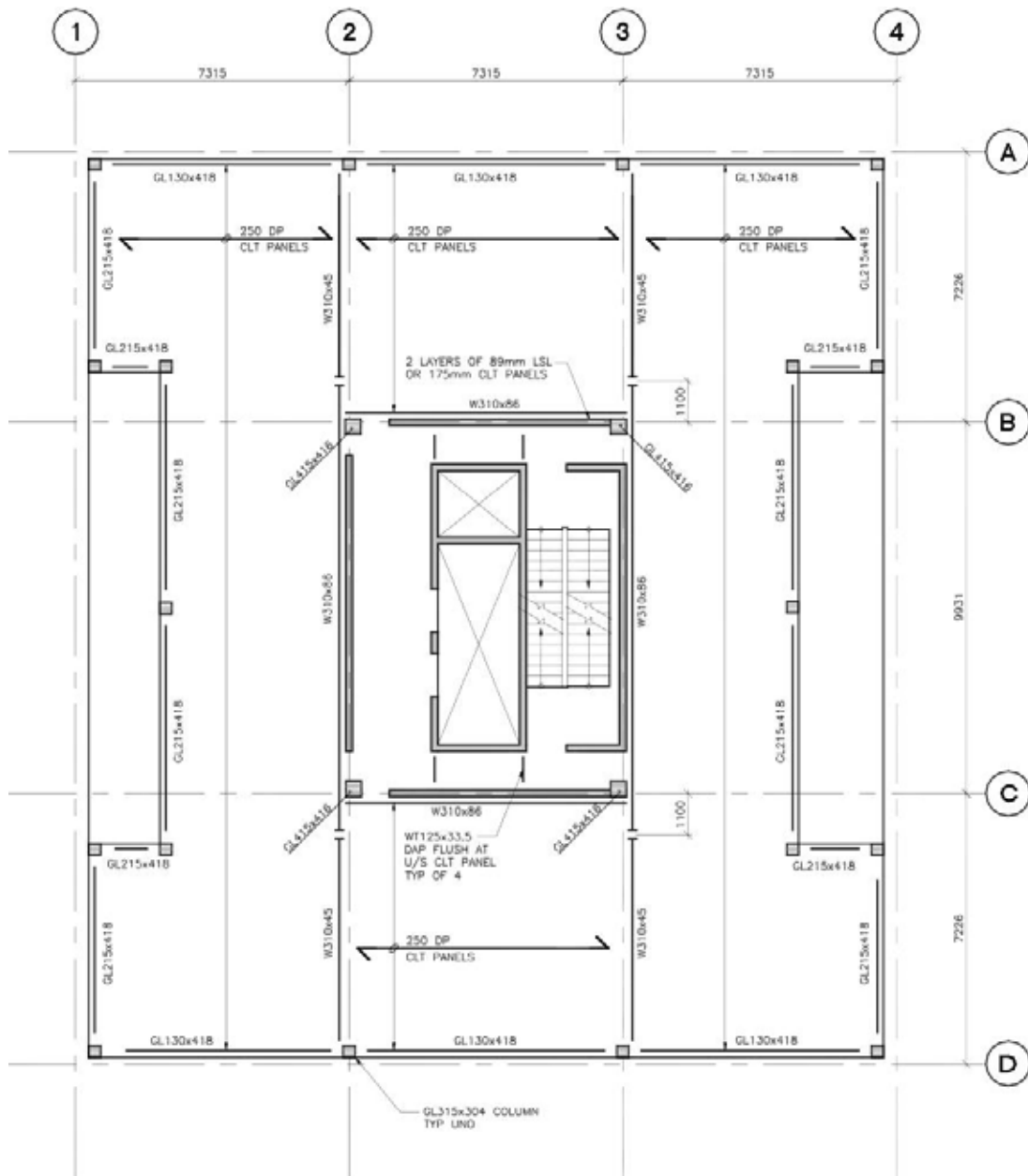

**Option 1 - 12 Storey**

NTS



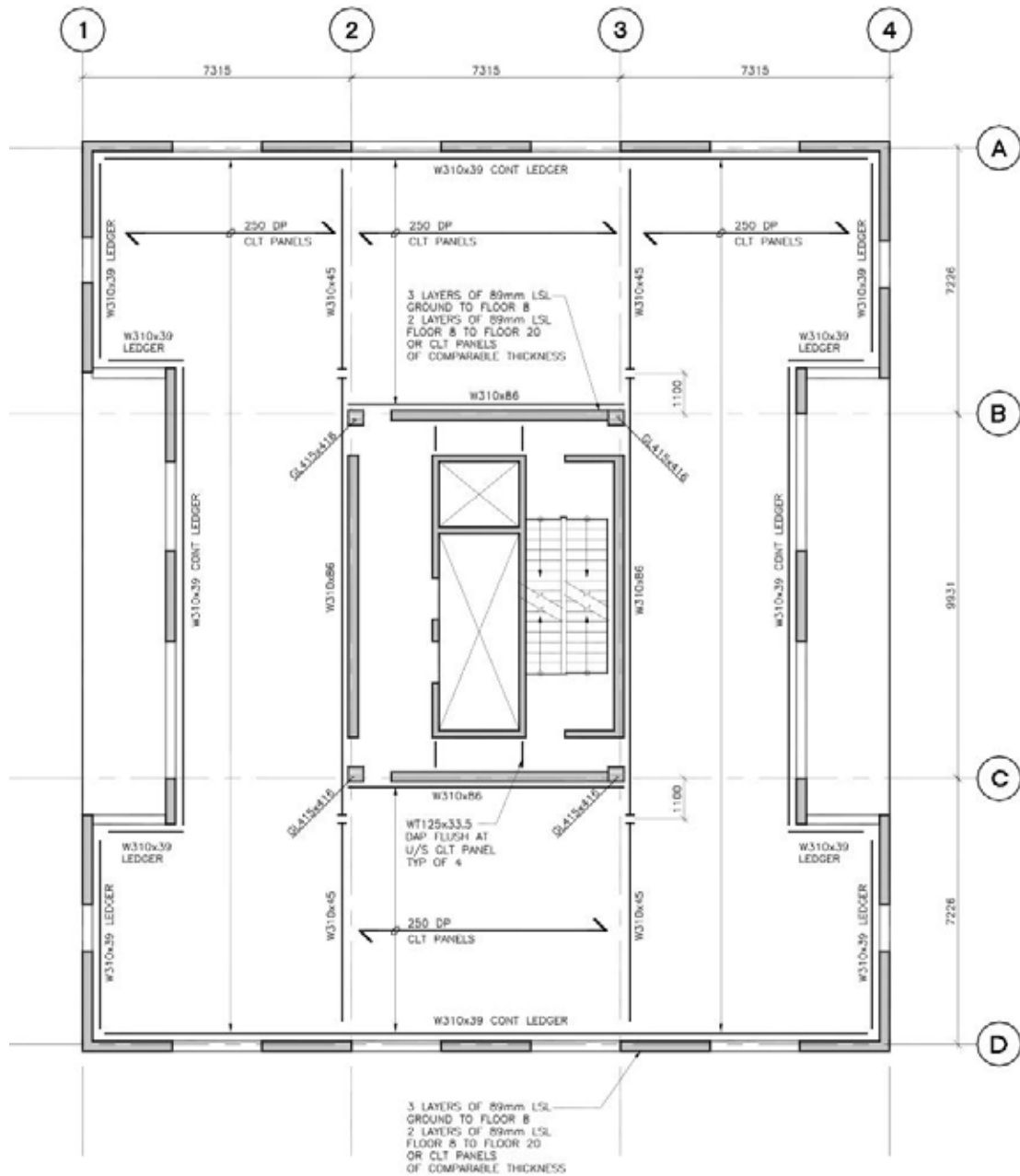

**Option 3 - 20 Storey**  
NTS

Note: Our analysis has shown that a 30 storey building of option 3 performed adequately.

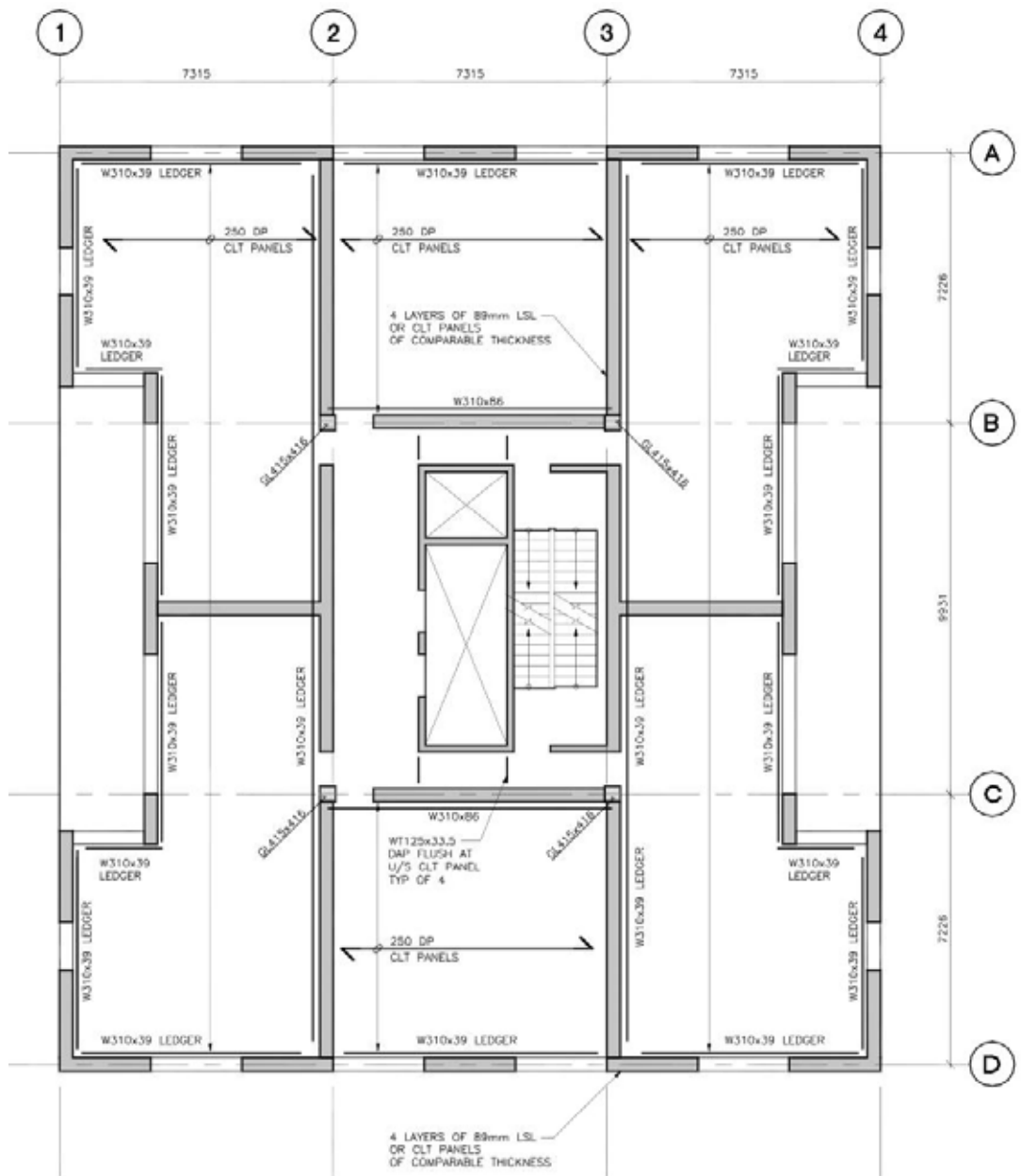

**Option 4 - 30 Storey**  
NTS

Note: Our analysis has shown that a 30 storey building of option 4 performed adequately with either the interior partition walls or perimeter frames.

## Gravity Resisting System

The floor and roof structure may be of CLT, laminated LSL panels or glue-laminated engineered wood panel construction, with or without composite or non-composite concrete topping. In the examples under consideration, the panels are assumed to span one-way east-west over interior steel beams which also act as core headers or link beams. A CLT panel thicknesses of 255mm is shown, and an LSL panel depth of 267mm has been assumed, using 3 layers of 89mm LSL, assumed to be glue laminated together in the shop.

The perimeter structure consists of glulam post and beam for Options A and B, and moment frames of solid wood panels and steel link beams for Options C and D. Typical columns will consist of glue-laminated timber which can be installed in multiple lifts to limit the number of or simplify connections from floor to floor.

While it is assumed at this time that dropped ceilings and wall finishes will be used in locations to provide fire protection and/or acoustic treatment and the concealment of services, spaces can be built into the panel assemblies to provide chases for services. In the case where charring is used as a strategy for fire protection, all member sizes would need to be checked and adjusted to meet the post-fire load case. Our preliminary analysis has shown that the charring design approach minimally impacts the sizing of the structural members in most cases (see following section on fire resistance as well as the architectural and code consultant reports).

## Floor Vibration

Floor vibration often governs the design of solid wood panel construction. Careful analysis of floor vibration must be included in the design of solid wood panel floors, particularly where concrete topping is omitted.

This said, the stiffness and feel of a properly designed solid wood panel floor will be much closer to that of a concrete slab than a light frame structure, often with a shallower depth, and can be nearly indiscernible from a concrete floor structure where concrete-wood composite is used.

## Lateral Load Resisting Systems

Using the inherent vertical strength of solid wood panel construction, the approach is to achieve “strong column / weak beam” shear wall and moment frame systems with good ductility and sufficient strength and stiffness to resist all required loading conditions.

The “strong columns”, would therefore consist of large CLT (cross-laminated timber) or engineered wood panel elements (LSL or LVL) glue-laminated to the required thicknesses. The “weak beams” would consist of ductile (class 1) wide flange beams, proportioned to develop plastic hinges at or near design load levels (as per the principles of capacity design), while providing the required stiffness, contributing to the overall ductility of the system. Reduced beam sections (RBS) can be used to achieve the desired hinge locations and capacities while retaining the majority of the beam stiffness.

Based on the typical residential tower floor plan illustrated in the architectural report, three lateral load resisting systems (LLRS) have been explored: 1) the core, 2) perimeter moment frames which would be integrated into the building facades, and 3) interior demising walls. These can be used individually or in combination, provided of course that code requirements regarding the combination of different lateral load resisting systems are followed.

Our preliminary analysis shows that the ductility level of the lateral load resisting system does not impact the final design significantly. Stiffness appears to govern in most cases, and wind loading will govern for higher buildings even in higher seismic zones, particularly if concrete topping is omitted and the building mass is relatively low.

### 1. Core walls and headers (moderate to high ductility)

- › Core walls would consist of “strong”, glue-laminated LSL or LVL panels or CLT’s installed vertically and connected together to form larger wall panels to form the core. “Weak” ductile wide flange steel beam headers, partially embedded into the panel face would connect individual core wall panels together over doors and other openings. The system’s ductility will vary with the design.

- › The steel headers would be proportioned to develop plastic hinges at or near design load levels (as per the principles of capacity design), while providing the required stiffness, contributing to the overall ductility of the system.
- › The header moments will be developed by direct end grain bearing of the header beam on the solid wood panel edges. No mechanical fasteners would usually be required, other than to stabilize the header beam into place.
- › The vertical joints between adjacent panels could consist of lapped joints (say  $\pm 150$ mm wide) connected with a large number of self-tapping mechanical fasteners over the full height of the core. This has been shown in CLT testing at UBC to provide significant additional ductility over single, homogeneous panel walls connected at the base only.
- › The horizontal joints can also consist of lapped joints (say 600mm wide), connected with numerous mechanical fasteners and/or keyed as required for higher shear loads.
- › Ductile hold down and shear connections will be provided to anchor the core at the base. Numerous options are available for this purpose.

## 2. Perimeter wall moment frames (high ductility)

- › Perimeter moment frames will consist of “strong” glue-laminated LSL, LVL or CLT vertical panel elements, linked by “weak” ductile (class 1) wide flange steel headers connecting the vertical panel elements to create ductile strong column / weak beam moment frames which can be integrated in the building façades.
- › The headers would be proportioned to develop plastic hinges at or near design load levels (as per the principles of capacity design), while providing the required stiffness, contributing to the overall ductility of the system.
- › The header moments will be developed by direct end grain bearing of the header beam on the solid wood panel edges. No mechanical fasteners are required, other than to stabilize the header beam into place.

- › This will provide flexible and reliable, high ductility moment frames with very simple connections, without the risk of brittle weld failures, a characteristic problem in steel moment frame structures.

## 3. Interior partitions/load-bearing walls (moderate to high ductility)

- › Interior walls can be made to be continuous and load-bearing from foundation to roof, and can be used as an integral part of the core structure.
- › Alternatively, they could be used as a complement to the primary LLRS (lateral load resisting system), much as drywall sheathing is used in combination with engineered wood panel shear-walls (OSB and plywood), to add stiffness to the primary lateral load resisting system and help control drift. Unlike drywall this strategy could allow the partitions to remain non load-bearing, but would require that the interior walls be connected to the floor diaphragms with connections sufficiently ductile to accommodate the drift of the primary LLRS at ultimate loading conditions.

Refer to the typical details further in the report for details of interior partitions built through and between floors.

Lateral Load Models

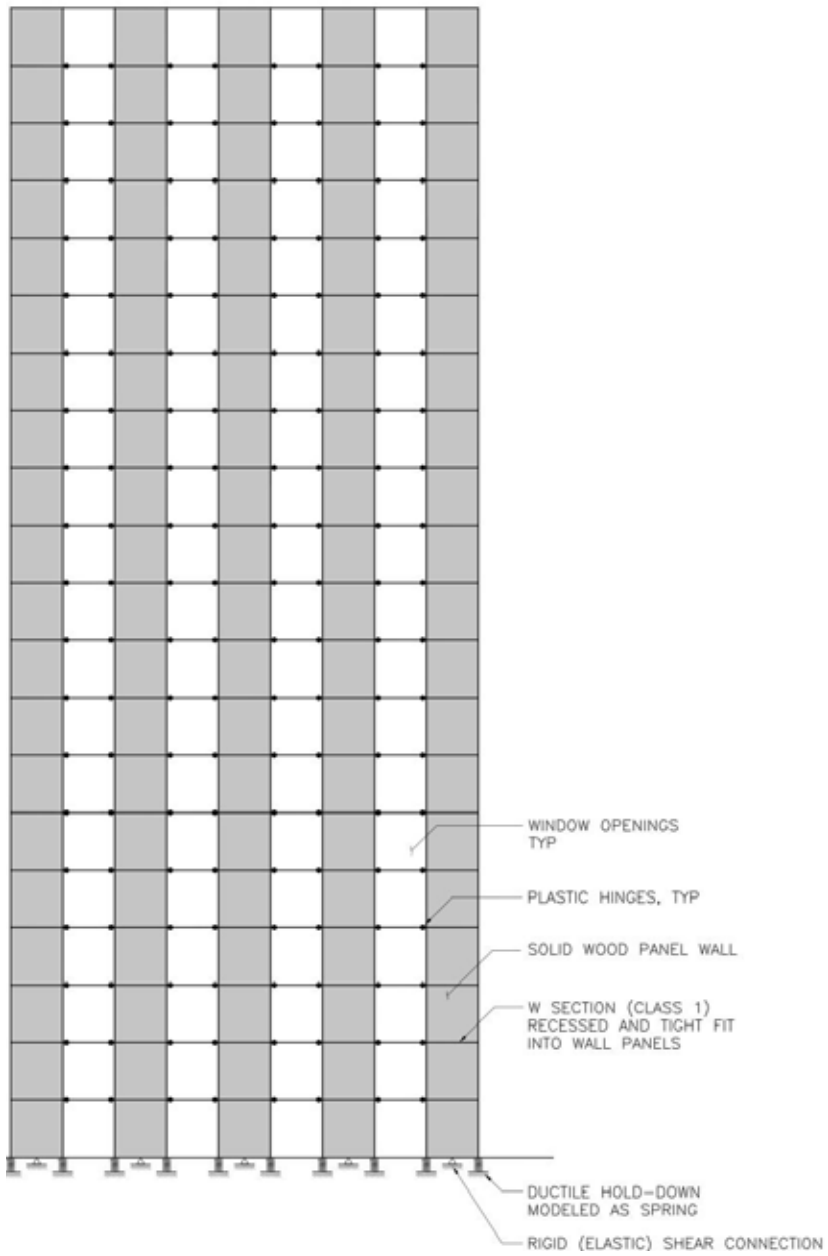

Typical Perimeter Moment Frame Model

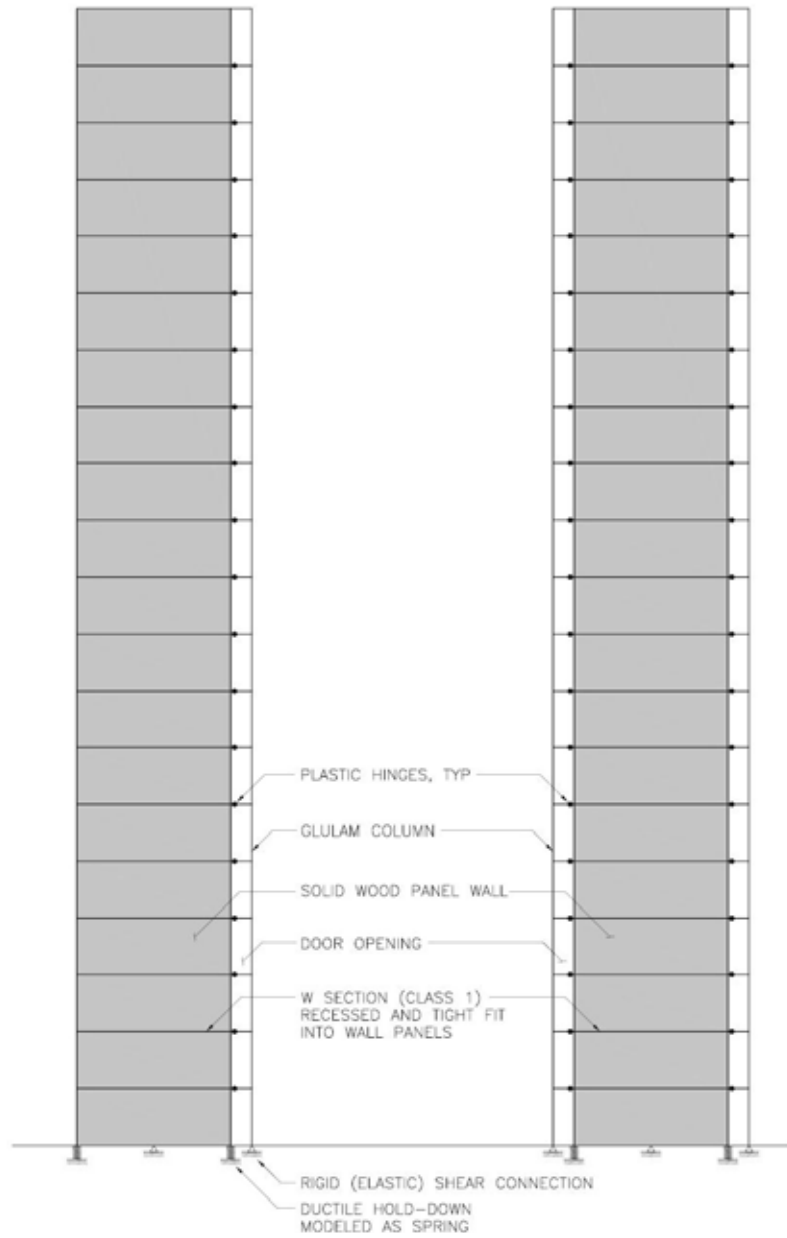

**Typical Core Model - NS and EW Elevations**



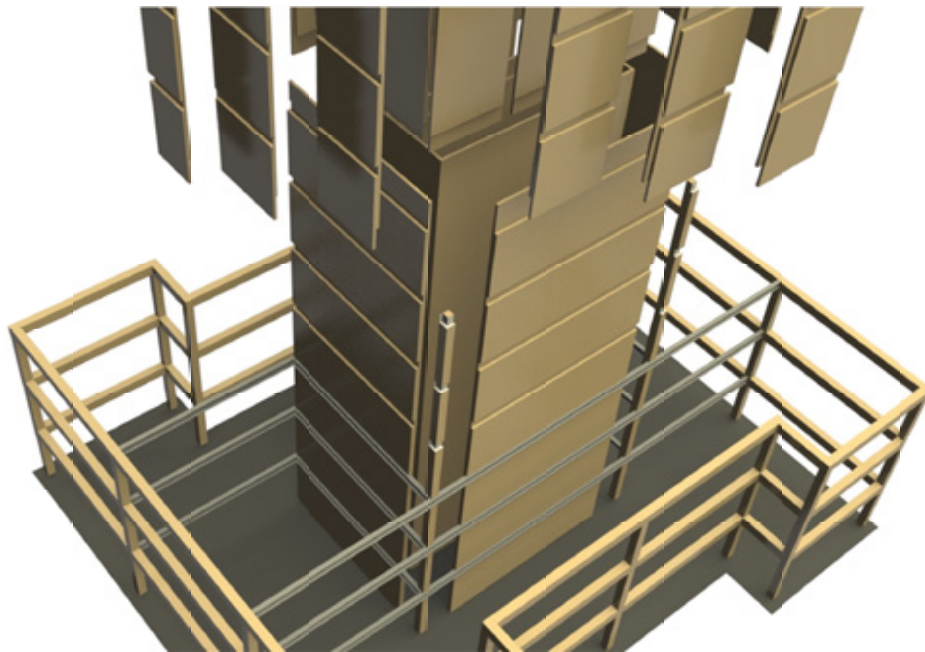

**Option 1 - 12 Storey with core**

Exploded view

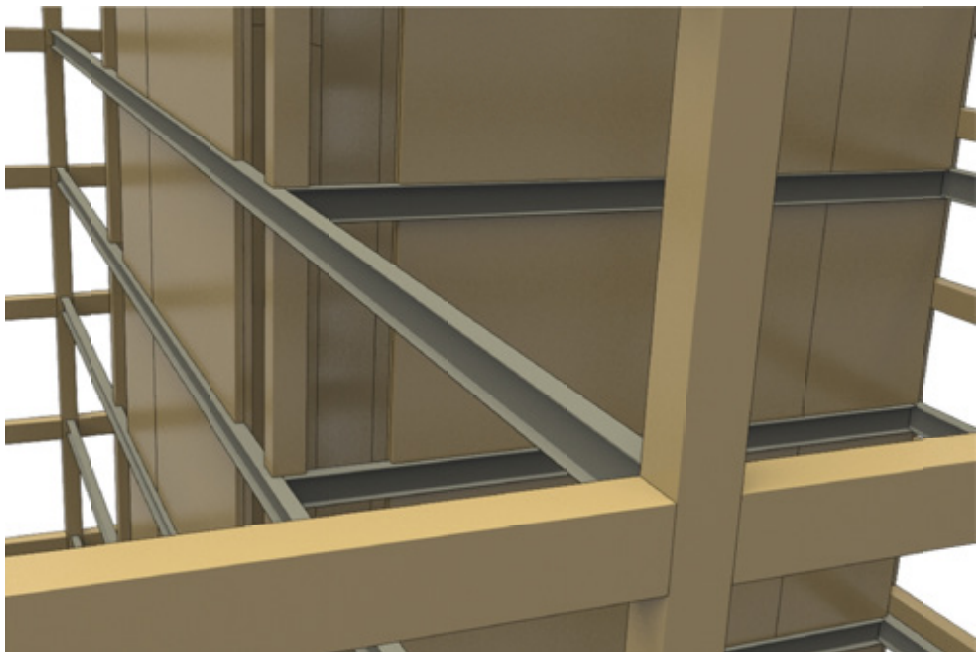
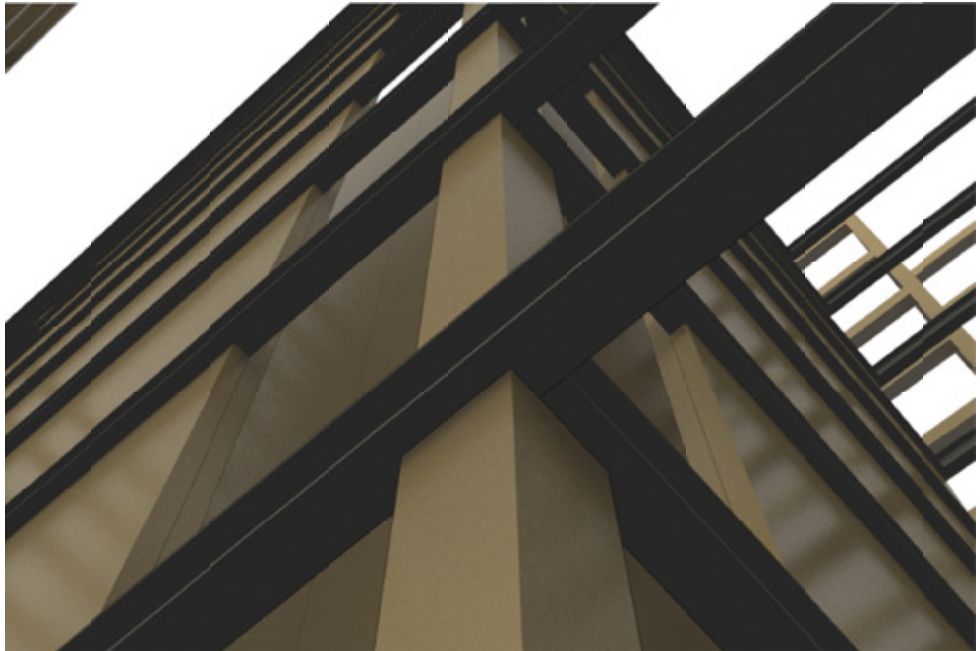

### **Close-up Views**

Solid panel core and intersecting ductile steel link beams

## R Values for Seismic Design

The “R” factors referenced in Section 4 of the National Building Code represent the level of ductility of a lateral load resisting system and are critical to the design of seismically resistant structures. All commonly used lateral load resisting systems are assigned an  $R_o$  and  $R_d$  value in the National Building Code. The higher the ductility of a system, the higher the associated “R” factors, and as a result, the lower the required seismic design forces. “R” values have yet to be assigned for solid wood panel construction in the building code but educated assumptions have been made for the purposes of this study.

Preliminary results of CLT shear wall panel tests conducted by FP Innovations laboratory at the University of British Columbia have shown good behaviour and ductility, for panels connected at the base with standard hold down anchors and “L” shaped shear connectors and screws. These displayed well-shaped hysteresis curves over 20 cycles or more. Because solid wood panels are proportionally extremely strong and rigid, the ductility must be provided by the connections.

On this basis, FPInnovations is recommending preliminary “R” values for CLT panels with simple, standard connections of:

- ›  $R_d = 2.0$
- ›  $R_o = 1.5$ .

This is in line with the existing code category “Braced Frames with Ductile Connections – Moderately Ductile (Timber)”. FPInnovations has also shown that the presence of screwed vertical lap joints in the panel assembly adds further ductility to the system.

The seismic forces used in the preliminary design of our prototypes are therefore based on  $R_d = 2.0$  and  $R_o = 1.5$ . It is our opinion however that the use of more sophisticated hold down details, in combination with numerous vertical lap joints and carefully designed ductile link beams in the perimeter moment frames as well as the core elements will provide considerable redundancy and energy dissipation opportunities and should justify significantly higher “R” values. Testing is of course required to confirm appropriate values for the design of various solid wood panel based lateral load resisting systems.

## Wall Thicknesses

The strength of engineered wood panels (LSL and LVL) and CLT’s, and the shear capacity in particular can be significantly higher than reinforced concrete. The building mass, and resulting seismic forces however are much lower. Consequently, from a lateral point of view, wood panel walls in cores in particular are expected to be thinner than concrete walls.

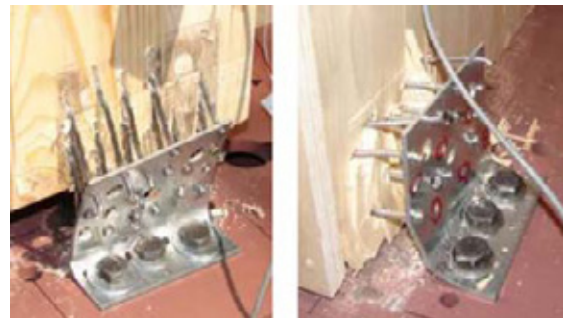

CLT Shearwall Test  
FPInnovations

**Lateral Loads**

As mentioned above, the seismic forces used in the preliminary design of our prototypes are based on 3 meter storey heights and  $R_d = 2.0$  and  $R_o = 1.5$ . Soil factors are based on a site class “C”, and a category “Normal” importance factor was assumed.

Based on this information, seismic base shears were calculated as follows:

- › 12 Storey Building:  $V_q = 0.148W$
- › 20 Storey Building:  $V_q = 0.091W$
- › 30 Storey Building:  $V_q = 0.057W$

Wind loading is based on  $q = 1/50 = 0.48$  kPa as summarized in the design data summarized above.

Following are tables summarizing the seismic and wind load calculations for the 12, 20 and 30-storey cases respectively:

**Project Name:**  
**Project No.:** 10075      **Location:** Vancouver

**By:** JEK  
**Date:** 4/20/2011  
**Ckd:**  
**Date:**

Note: Not applicable to structures of Site Class "F", some irregular structures per 4.1.8.6. & 4.1.8.7.  
 Engineer should check the irregularity of the structures to make sure Equivalent Static Force Procedure applies.

Seismic Data				
Sa(0.2)	Sa(0.5)	Sa(1.0)	Sa(2.0)	PGA
0.94	0.63	0.33	0.17	0.47

Number of stories N	12
Height of Model $h_n$	36 m
Site Class	C
$I_E$	1.0
<b>Type of SFRS</b>	<b>TB 4.1.8.9. Braced frames with ductile connections Moderately ductile(Timber)</b>
$T_a$	0.900 4.1.8.11.3.
$F_a$	1.000 TB 4.1.8.4.B.
$F_v$	1.000 TB 4.1.8.4.C.
	0.940
$S(T_a < 0.2)$	0.940
$S(0.5)$	0.630
$S(1.0)$	0.330 4.1.8.4.6.
$S(2.0)$	0.170
$S(T_a > 4.0)$	0.085
	0.085
$S(T_a)$	0.390
$R_d$	2.0 TB. 4.1.8.9.
$R_o$	1.5
$M_v$	1.000 TB. 4.1.8.11.
J	0.947
V/W	0.130 4.1.8.11.2.
$I_E * F_a * S_a(0.2)$	0.940
$I_E * F_v * S_a(1.0)$	0.330
Height limit	TB 4.1.8.9. 20 m

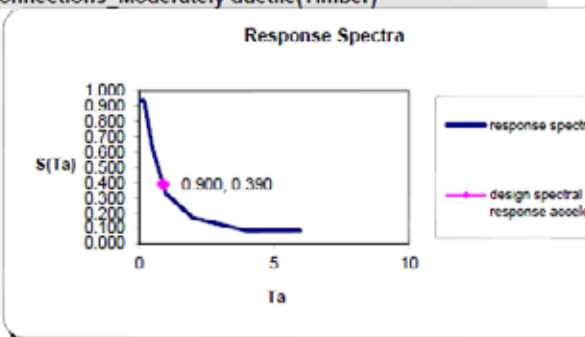

Project Name:  
 Project No.: 10075 Location: Vancouver

By JEK  
 Date 4/20/2011  
 Ckd  
 Date

Note: Not applicable to structures of Site Class "F", some irregular structures per 4.1.8.6. & 4.1.8.7.  
 Engineer should check the irregularity of the structures to make sure Equivalent Static Force Procedure applies.

Seismic Data				
Sa(0.2)	Sa(0.5)	Sa(1.0)	Sa(2.0)	PGA
0.94	0.63	0.33	0.17	0.47

Number of stories N		20
Height of Model $h_n$		60 m
Site Class		C
$I_E$		1.0
Type of SFRS	TB 4.1.8.9.	Braced frames with ductile connections Moderately ductile(Timber)
$T_a$		1.500 4.1.8.11.3.
$F_a$		1.000 TB 4.1.8.4.B.
$F_v$		1.000 TB 4.1.8.4.C.
$S(T_a \leq 0.2)$		0.940
$S(0.5)$		0.630
$S(1.0)$		0.330 4.1.8.4.6.
$S(2.0)$		0.170
$S(T_a \geq 4.0)$		0.085
$S(T_a)$		0.250
$R_d$		2.0
$R_o$		1.5 TB. 4.1.8.9.
$M_v$		1.000
J		0.867 TB. 4.1.8.11.
V/W		0.083 4.1.8.11.2.
$I_E * F_a * S_a(0.2)$		0.940
$I_E * F_v * S_a(1.0)$		0.330
Height Limit	TB 4.1.8.9.	20 m
is OK?		N.G.

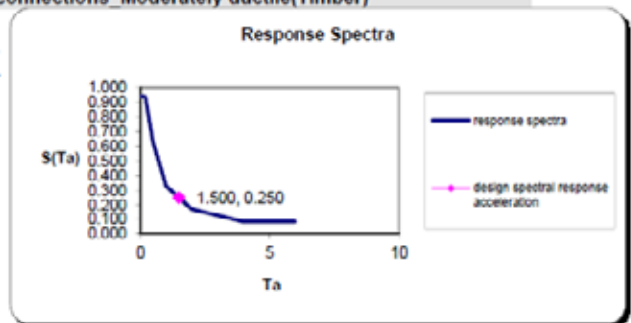

Project Name:  
 Project No.: 10075 Location: Vancouver

By JEK  
 Date 4/20/2011  
 Ckd  
 Date

Note: Not applicable to structures of Site Class "F", some irregular structures per 4.1.8.6. & 4.1.8.7.  
 Engineer should check the irregularity of the structures to make sure Equivalent Static Force Procedure applies.

Seismic Data				
Sa(0.2)	Sa(0.5)	Sa(1.0)	Sa(2.0)	PGA
0.94	0.63	0.33	0.17	0.47

Number of stories N		30
Height of Model $h_n$		90 m
Site Class		C
$I_E$		1.0
Type of SFRS	TB 4.1.8.9.	Braced frames with ductile connections Moderately ductile(Timber)
$T_a$		2.250 4.1.8.11.3.
$F_a$		1.000 TB 4.1.8.4.B.
$F_v$		1.000 TB 4.1.8.4.C.
$S(T_a < 0.2)$		0.940
$S(0.5)$		0.940
$S(1.0)$		0.630
$S(2.0)$		0.330 4.1.8.4.6.
$S(T_a > 4.0)$		0.170
		0.085
		0.085
$S(T_a)$		0.159
$R_d$		2.0
$R_o$		1.5 TB. 4.1.8.9.
$M_v$		1.000
J		0.800 TB. 4.1.8.11.
V/W		0.057 4.1.8.11.2.
$I_E * F_a * S_a(0.2)$		0.940
$I_E * F_v * S_a(1.0)$		0.330
Height Limit	TB 4.1.8.9.	20 m
is OK?		N.G.

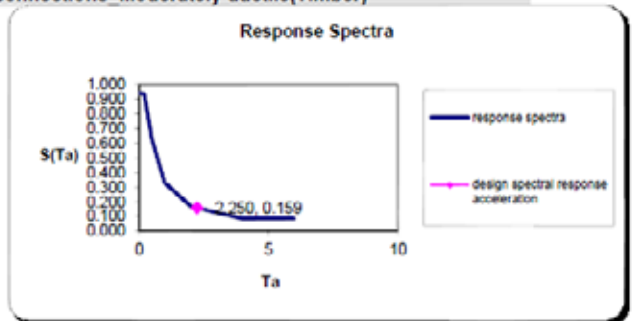

12-Storey Building

Seismic Load Distribution

LEVEL	Trib Area (m <sup>2</sup> )	wx (kPa)	Wx (kN)	hx (m)	Wxhx	$\frac{Wxhx}{\sum Wxhx}$	Fx (kN)	/m width	$\sum Fx$ Base of wall	Jx
0								kN/m	2106	0.84
1	450	3.00	1350	3.0	4050	0.015	30	2.6	2076	0.04
2	450	3.00	1350	6.0	8100	0.030	60	5.2	2016	0.84
3	450	3.00	1350	9.0	12150	0.045	90	7.7	1927	0.84
4	450	3.00	1350	12.0	16200	0.061	120	10.3	1807	0.84
5	450	3.00	1350	15.0	20250	0.076	149	12.9	1658	0.84
6	450	3.00	1350	18.0	24300	0.091	179	15.5	1478	0.84
7	450	3.00	1350	21.0	28350	0.106	209	18.1	1269	0.84
8	450	3.00	1350	24.0	32400	0.121	239	20.6	1030	0.84
9	450	3.00	1350	27.0	36450	0.136	269	23.2	761	0.84
10	450	3.00	1350	30.0	40500	0.152	299	25.8	462	0.04
11	450	3.00	1350	33.0	44550	0.167	329	28.4	133	0.84
12	450	3.00	1350	36.0	48600	0.182	133	11.4	0	0.84
			16200	315900			2106			

Ta = 0.9 s

V = 0.13 \*W = 2106 kN

Ft = 133 kN

12 Storey Building

Wind Load Distribution											
LEVEL	Trib Area (m <sup>2</sup> )	w <sub>x</sub> (kPa)	W <sub>x</sub> (kN)	h <sub>x</sub> (m)	W <sub>x</sub> h <sub>x</sub>	W <sub>x</sub> h <sub>x</sub> Σ W <sub>x</sub> h <sub>x</sub>	C <sub>p</sub> C <sub>g</sub>	C <sub>e</sub>	F <sub>x</sub>	F <sub>x</sub> applied to each floor	/m k
0											
1	450	3.00	1350	3.0	4050	0.015	2	0.70	44	22	
2	450	3.00	1350	6.0	8100	0.030	2	0.70	44	44	
3	450	3.00	1350	9.0	12150	0.045	2	0.70	44	44	
4	450	3.00	1350	12.0	16200	0.061	2	0.70	44	44	
5	450	3.00	1350	15.0	20250	0.076	2	0.75	47	46	
6	450	3.00	1350	18.0	24300	0.091	2	0.79	50	49	
7	450	3.00	1350	21.0	28350	0.106	2	0.83	52	51	
8	450	3.00	1350	24.0	32400	0.121	2	0.86	55	54	
9	450	3.00	1350	27.0	36450	0.136	2	0.89	57	56	
10	450	3.00	1350	30.0	40500	0.152	2	0.92	58	57	
11	450	3.00	1350	33.0	44550	0.167	2	0.95	60	59	
12	450	3.00	1350	36.0	48600	0.182	2	0.97	62	61	
			16200		315900				619		31
							q 0.48 kPa Bdg width 22 m Panel width 26 ft 11.59 m				



20-Storey Building

Seismic Load Distribution										
LEVEL	Trib Area (m <sup>2</sup> )	w <sub>x</sub> (kPa)	W <sub>x</sub> (kN)	h <sub>x</sub> (m)	W <sub>x</sub> h <sub>x</sub>	$\frac{W_x h_x}{\sum W_x h_x}$	F <sub>x</sub> (kN)	/m width Base of wall	$\sum F_x$	J <sub>x</sub>
0								kN/m	2166	0.84
1	450	3.00	1350	3.0	4050	0.005	10	0.9	2156	0.84
2	450	3.00	1350	6.0	8100	0.011	20	1.8	2136	0.84
3	450	3.00	1350	9.0	12150	0.016	31	2.6	2105	0.84
4	450	3.00	1350	12.0	16200	0.021	41	3.5	2064	0.84
5	450	3.00	1350	15.0	20250	0.026	51	4.4	2013	0.84
6	450	3.00	1350	18.0	24300	0.032	61	5.3	1952	0.84
7	450	3.00	1350	21.0	28350	0.037	71	6.2	1881	0.84
8	450	3.00	1350	24.0	32400	0.042	82	7.0	1799	0.84
9	450	3.00	1350	27.0	36450	0.047	92	7.9	1707	0.84
10	450	3.00	1350	30.0	40500	0.053	102	8.8	1605	0.84
11	450	3.00	1350	33.0	44550	0.058	112	9.7	1493	0.84
12	450	3.00	1350	36.0	48600	0.063	122	10.6	1370	0.84
13	450	3.00	1350	39.0	52650	0.068	133	11.4	1238	0.84
14	450	3.00	1350	42.0	56700	0.074	143	12.3	1095	0.84
15	450	3.00	1350	45.0	60750	0.079	153	13.2	942	0.84
16	450	3.00	1350	48.0	64800	0.084	163	14.1	778	0.84
17	450	3.00	1350	51.0	68850	0.089	173	15.0	605	0.84
18	450	3.00	1350	54.0	72900	0.095	184	15.8	421	0.84
19	450	3.00	1350	57.0	76950	0.100	194	16.7	227	0.84
20	450	1.00	450	60.0	27000	0.035	227	19.6		
			26100	796500			2166			
Ta =				1.5 s						
V =		0.003		*W =		2166 kN				
Fl =						227 kN				

20-Storey Building

Wind Load Distribution											
LEVEL	Trib Area (m <sup>2</sup> )	w <sub>x</sub> (kPa)	W <sub>x</sub> (kN)	h <sub>x</sub> (m)	W <sub>x</sub> h <sub>x</sub>	$\frac{W_x h_x}{\sum W_x h_x}$	C <sub>p</sub> C <sub>g</sub>	C <sub>e</sub>	F <sub>x</sub>	F <sub>x</sub> applied to each floor	/m kN
0											
1	450	3.00	1350	3.0	4050	0.005	2	0.70	44	22	
2	450	3.00	1350	6.0	8100	0.011	2	0.70	44	44	
3	450	3.00	1350	9.0	12150	0.016	2	0.70	44	44	
4	450	3.00	1350	12.0	16200	0.021	2	0.70	44	44	
5	450	3.00	1350	15.0	20250	0.026	2	0.75	47	46	
6	450	3.00	1350	18.0	24300	0.032	2	0.79	50	49	
7	450	3.00	1350	21.0	28350	0.037	2	0.83	52	51	
8	450	3.00	1350	24.0	32400	0.042	2	0.86	55	54	
9	450	3.00	1350	27.0	36450	0.047	2	0.89	57	56	
10	450	3.00	1350	30.0	40500	0.053	2	0.92	58	57	
11	450	3.00	1350	33.0	44550	0.058	2	0.95	60	59	
12	450	3.00	1350	36.0	48600	0.063	2	0.97	62	61	
13	450	3.00	1350	39.0	52650	0.068	2	1.00	63	62	
14	450	3.00	1350	42.0	56700	0.074	2	1.02	65	64	
15	450	3.00	1350	45.0	60750	0.079	2	1.04	66	65	
16	450	3.00	1350	48.0	64800	0.084	2	1.06	67	67	
17	450	3.00	1350	51.0	68850	0.089	2	1.08	68	68	
18	450	3.00	1350	54.0	72900	0.095	2	1.10	70	69	
19	450	3.00	1350	57.0	76950	0.100	2	1.12	71	70	
20	450	1.00	450	60.0	27000	0.035					35
			26100			796500			1088		
							q	0.48 kPa			
							Bdg width	22 m			
							Panel width	38 ft	11.59 m		

## 30-Storey Building

## Seismic Load Distribution

LEVEL	Trib Area (m <sup>2</sup> )	wx (kPa)	Wx (kN)	hx (m)	Wxhx	$\frac{Wxhx}{\sum Wxhx}$	Fx (kN)	/m width kN/m	$\sum Fx$ Base of wall	Jx
0									1448	0.80
1	450	3.00	1350	3.0	4050	0.002	4	0.2	1444	0.80
2	450	3.00	1350	6.0	8100	0.005	9	0.4	1435	0.80
3	450	3.00	1350	9.0	12150	0.007	13	0.6	1422	0.80
4	450	3.00	1350	12.0	16200	0.009	17	0.8	1405	0.80
5	450	3.00	1350	15.0	20250	0.011	22	1.0	1383	0.80
6	450	3.00	1350	18.0	24300	0.014	26	1.2	1357	0.80
7	450	3.00	1350	21.0	28350	0.016	31	1.4	1326	0.80
8	450	3.00	1350	24.0	32400	0.018	35	1.5	1291	0.80
9	450	3.00	1350	27.0	36450	0.021	39	1.7	1252	0.80
10	450	3.00	1350	30.0	40500	0.023	44	1.9	1208	0.80
11	450	3.00	1350	33.0	44550	0.025	48	2.1	1160	0.80
12	450	3.00	1350	36.0	48600	0.028	52	2.3	1107	0.80
13	450	3.00	1350	39.0	52650	0.030	57	2.5	1051	0.80
14	450	3.00	1350	42.0	56700	0.032	61	2.7	946	0.80
15	450	3.00	1350	45.0	60750	0.034	66	2.9	836	0.80
16	450	3.00	1350	48.0	64800	0.037	70	3.1	723	0.80
17	450	3.00	1350	51.0	68850	0.039	74	3.3	605	0.80
18	450	3.00	1350	54.0	72900	0.041	79	3.5	482	0.80
19	450	3.00	1350	57.0	76950	0.044	83	3.7	356	0.80
20	450	3.00	1350	60.0	81000	0.046	87	3.9	223	0.80
21	450	3.00	1350	63.0	85050	0.048	92	4.1	96	0.80
22	450	3.00	1350	66.0	89100	0.051	96	4.3	0	0.80
23	450	3.00	1350	69.0	93150	0.053	101	4.5		0.80
24	450	3.00	1350	72.0	97200	0.055	105	4.6		0.80
25	450	3.00	1350	75.0	101250	0.057	109	4.8		0.80
26	450	3.00	1350	78.0	105300	0.060	114	5.0		0.80
27	450	3.00	1350	81.0	109350	0.062	118	5.2		0.80
28	450	3.00	1350	84.0	113400	0.064	122	5.4		0.80
29	450	3.00	1350	87.0	117450	0.067	127	5.6		0.80
30	450	1.00	450	90.0	40500	0.023	356	15.8		
			39600		1802250		2257			
Ta =				2.25 s						
V =		0.057		*W =		2257 kN				

30-Storey Building

Wind Load Distribution											
LEVEL	Trib Area (m <sup>2</sup> )	w <sub>x</sub> (kPa)	W <sub>x</sub> (kN)	h <sub>x</sub> (m)	W <sub>x</sub> h <sub>x</sub>	W <sub>x</sub> h <sub>x</sub> ΣW <sub>x</sub> h <sub>x</sub>	C <sub>p</sub> C <sub>g</sub>	C <sub>e</sub>	F <sub>x</sub>	F <sub>x</sub> applied to each floor kN	/m <sup>2</sup> kN
0											
1	450	3.00	1350	3.0	4050	0.002	2.6	0.70	58	29	
2	450	3.00	1350	6.0	8100	0.005	2.6	0.70	58	58	
3	450	3.00	1350	9.0	12150	0.007	2.6	0.70	50	50	
4	450	3.00	1350	12.0	16200	0.009	2.6	0.70	58	58	
5	450	3.00	1350	15.0	20250	0.011	2.6	0.75	62	60	
6	450	3.00	1350	18.0	24300	0.014	2.6	0.79	65	63	
7	450	3.00	1350	21.0	28350	0.016	2.6	0.83	60	67	
8	450	3.00	1350	24.0	32400	0.018	2.6	0.86	71	70	
9	450	3.00	1350	27.0	36450	0.021	2.6	0.89	74	72	
10	450	3.00	1350	30.0	40500	0.023	2.6	0.92	76	75	
11	450	3.00	1350	33.0	44550	0.025	2.6	0.95	78	77	
12	450	3.00	1350	36.0	48600	0.028	2.6	0.97	80	79	
13	450	3.00	1350	39.0	52650	0.030	2.6	1.00	82	81	
14	450	3.00	1350	42.0	56700	0.032	2.6	1.02	84	83	
15	450	3.00	1350	45.0	60750	0.034	2.6	1.04	86	85	
16	450	3.00	1350	48.0	64800	0.037	2.6	1.06	87	87	
17	450	3.00	1350	51.0	68850	0.039	2.6	1.08	89	88	
18	450	3.00	1350	54.0	72900	0.041	2.6	1.10	91	90	
19	450	3.00	1350	57.0	76950	0.044	2.6	1.12	92	91	
20	450	3.00	1350	60.0	81000	0.046	2.6	1.13	93	93	
21	450	3.00	1350	63.0	85050	0.048	2.6	1.15	95	94	
22	450	3.00	1350	66.0	89100	0.051	2.6	1.17	96	95	
23	450	3.00	1350	69.0	93150	0.053	2.6	1.18	97	97	
24	450	3.00	1350	72.0	97200	0.055	2.6	1.20	99	98	
25	450	3.00	1350	75.0	101250	0.057	2.6	1.21	100	99	
26	450	3.00	1350	78.0	105300	0.060	2.6	1.23	101	101	
27	450	3.00	1350	81.0	109350	0.062	2.6	1.24	102	102	
28	450	3.00	1350	84.0	113400	0.064	2.6	1.25	103	103	
29	450	3.00	1350	87.0	117450	0.067	2.6	1.27	104	104	
30	450	1.00	450	90.0	40500	0.023					52
			39600	1802250				2407			
							q	0.48 kPa			
							Bdg width	22 m			

Typical Details

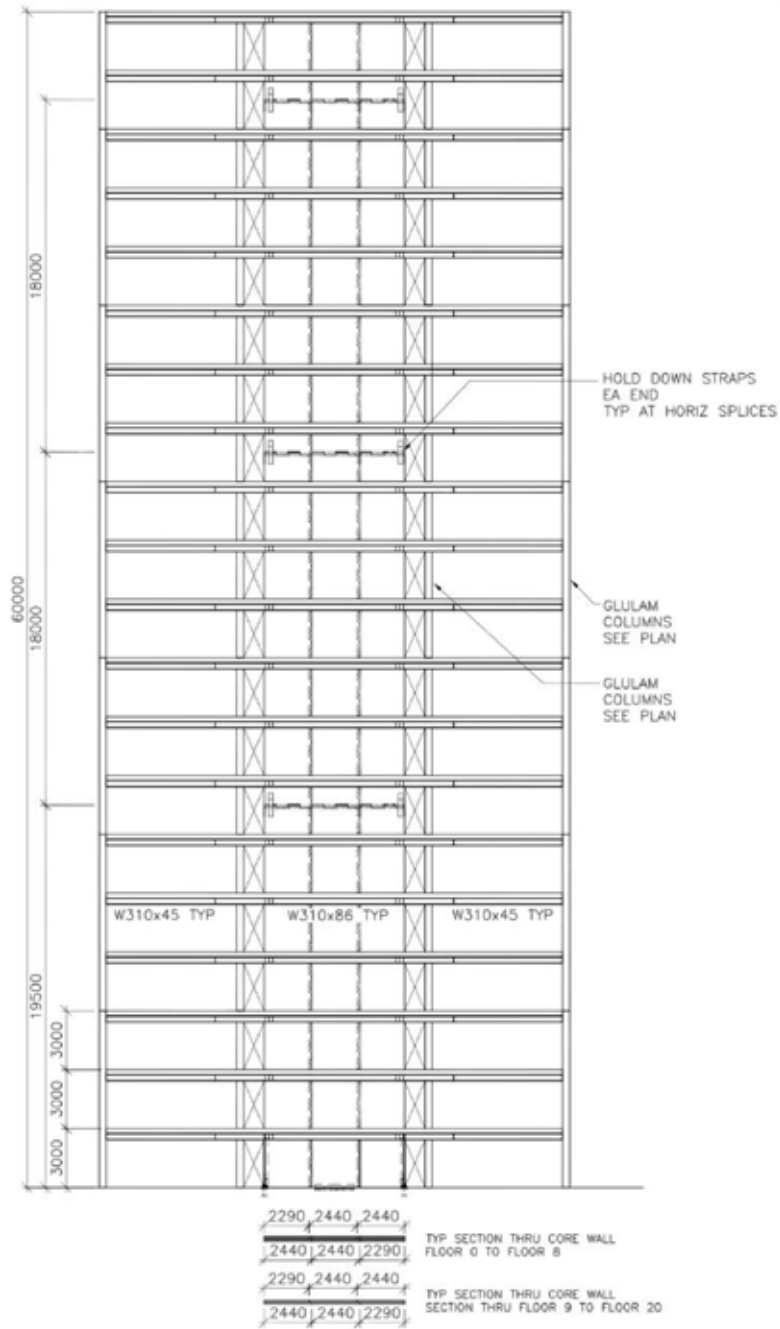

Typical Core Wall

20 Storey

1:250

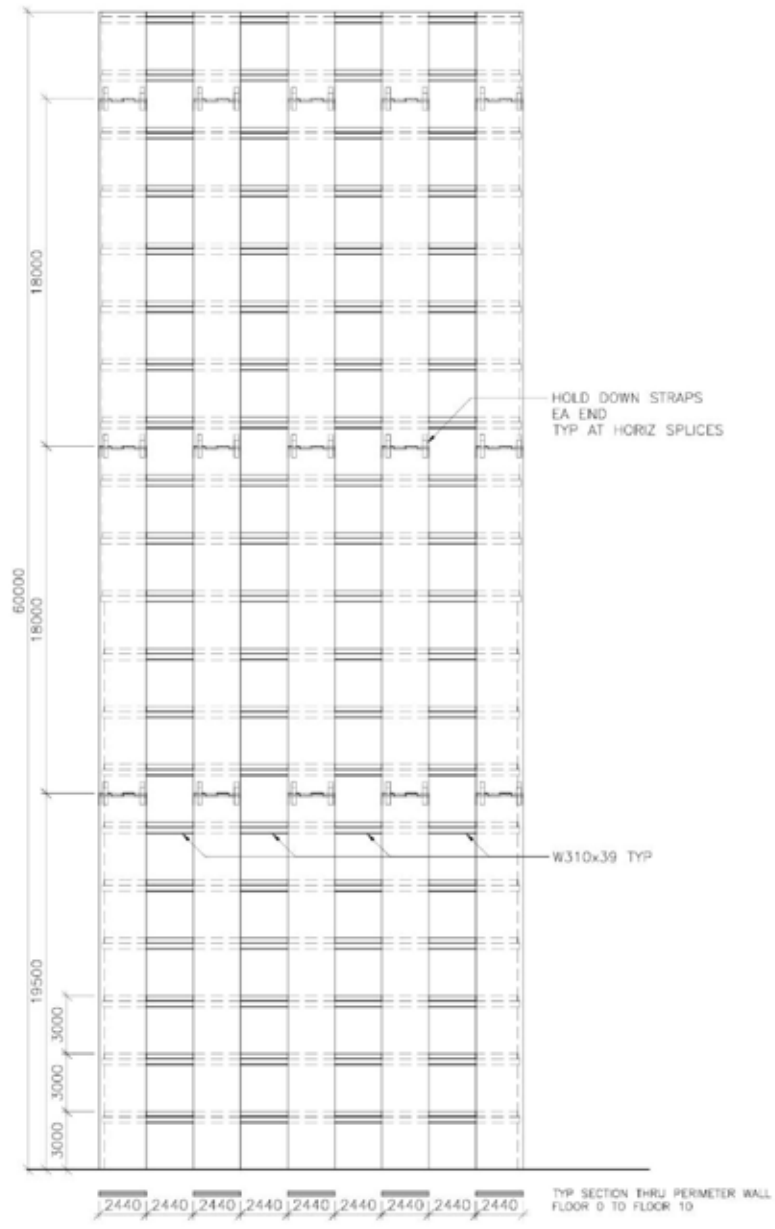

**Typical Perimeter Moment Frame**

20 Storey

1:250

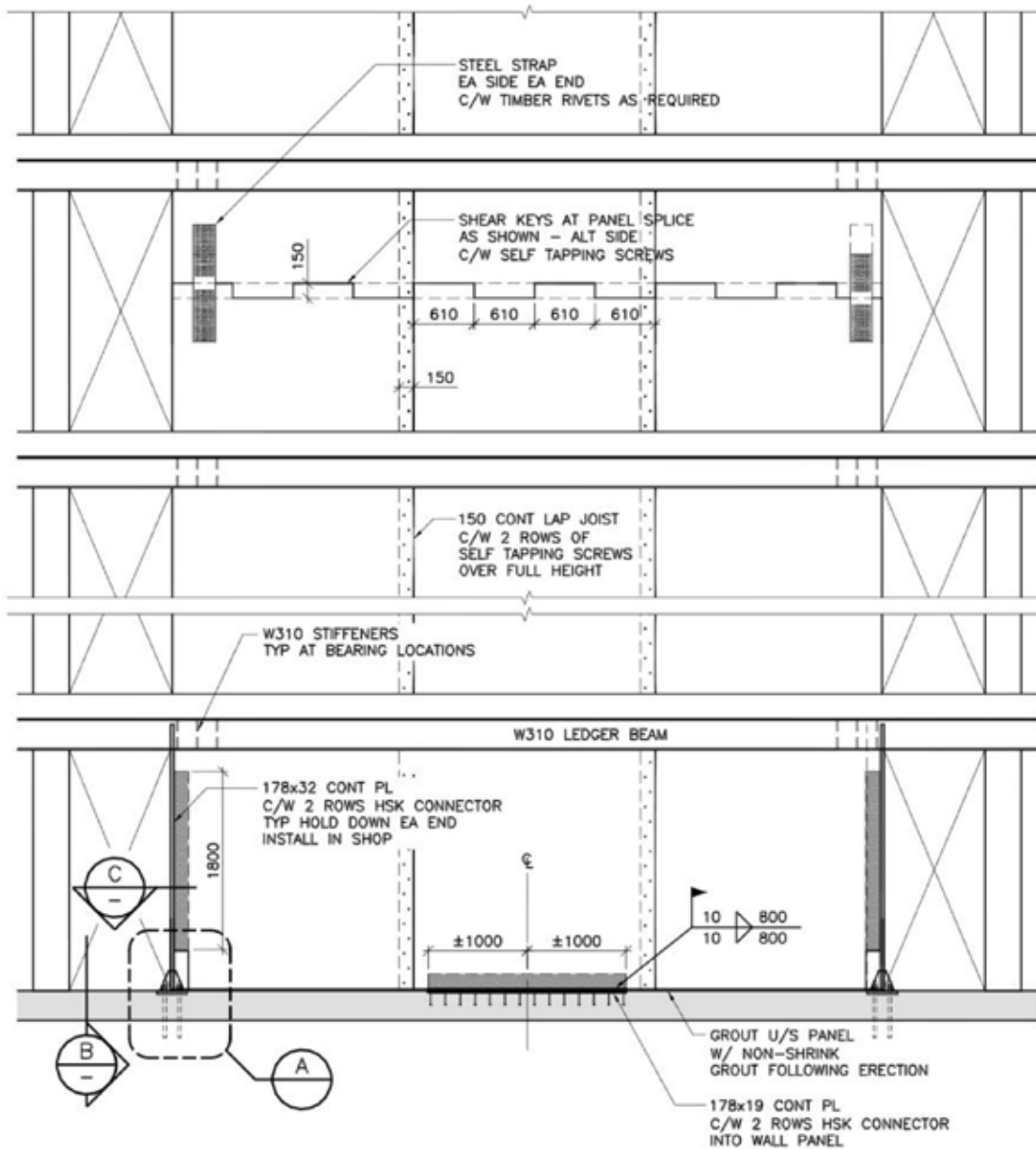

Panel Connection Detail

1:50

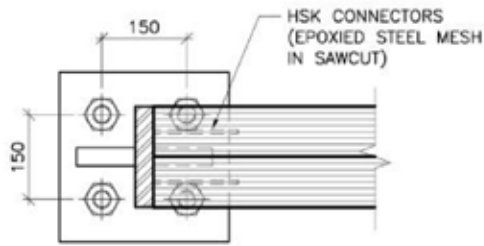

**C DETAIL**  
1:10

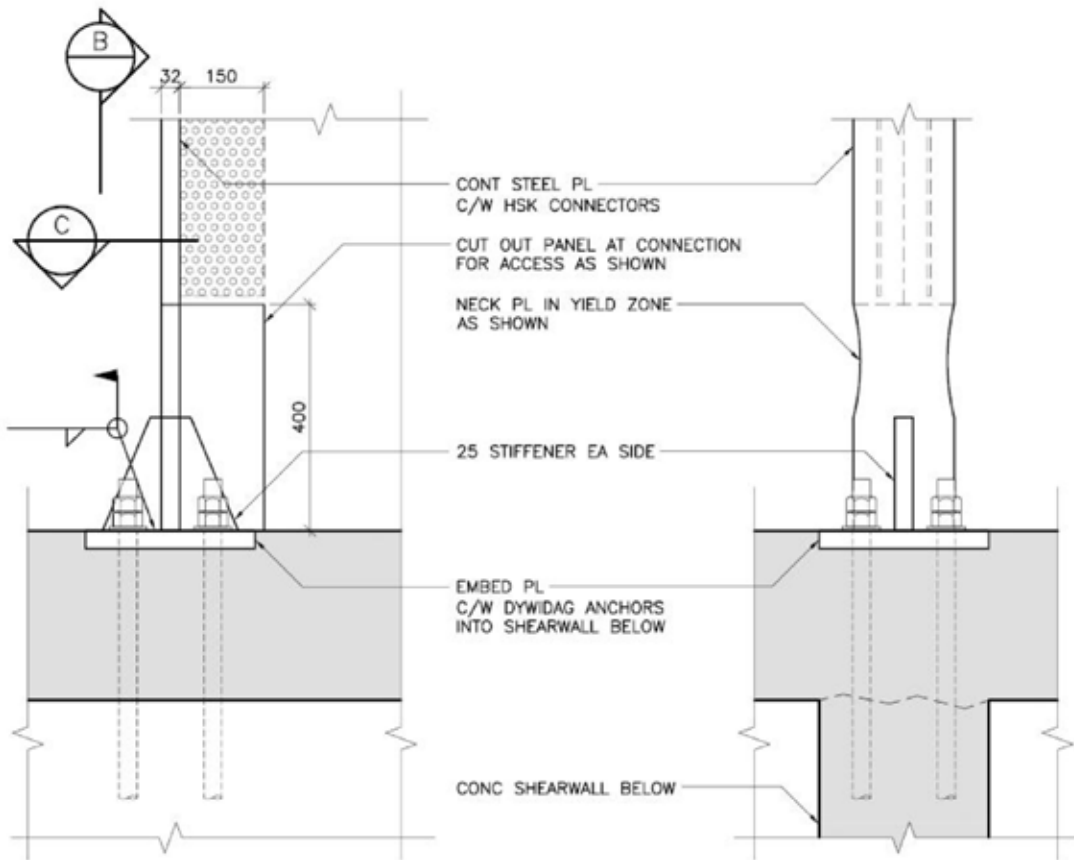

**A DETAIL**  
1:10

**B DETAIL**  
1:10

**Typical Hold Down - 12 Storey**

1:10



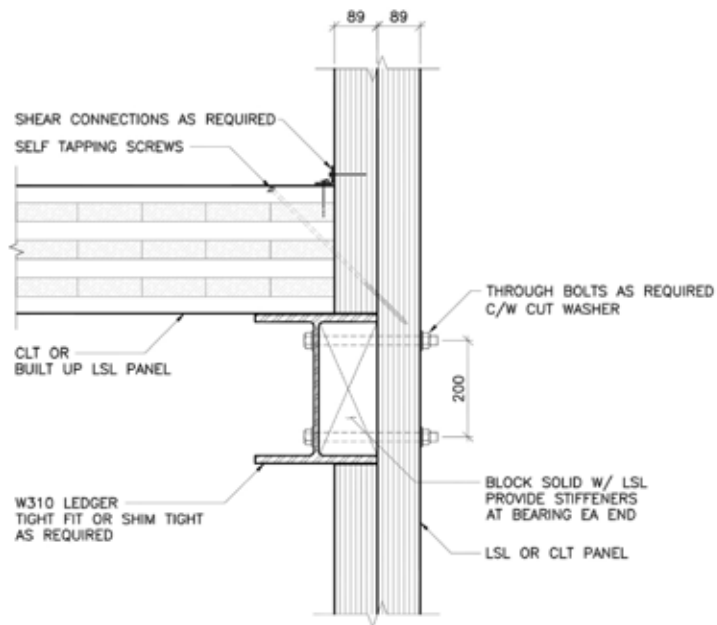

**Section Details - Ledger Connection**  
**Double LSL Panel or 175 CLT**

1:10 Typical at core or at moment frames

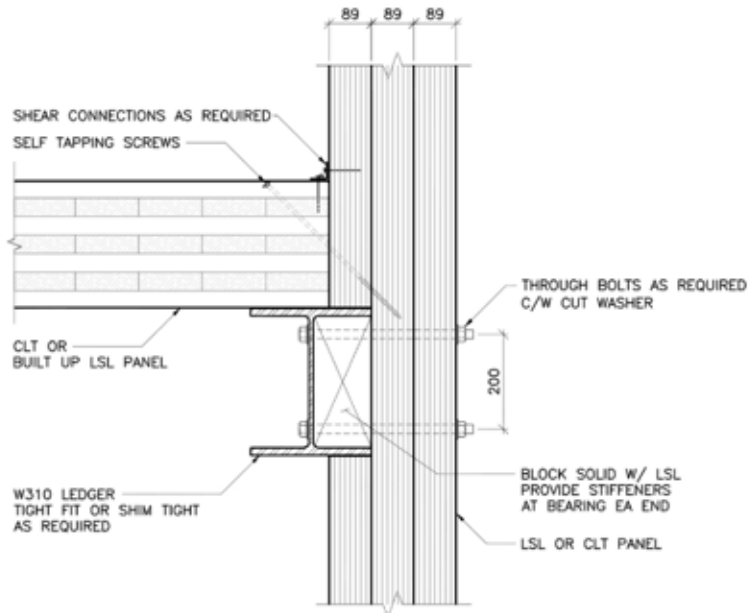

**Section Details - Ledger Connection**  
**Triple LSL Panel or 175 CLT**

1:10 Typical at core or at moment frames

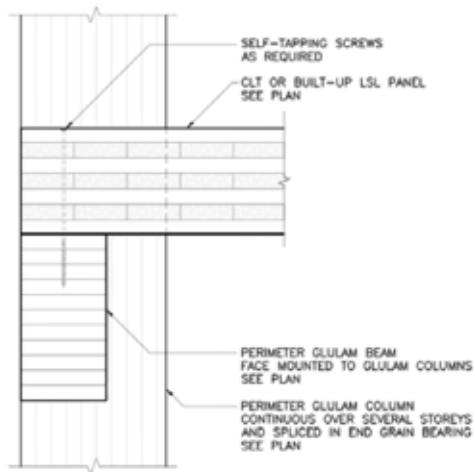

**Section Detail - Typical Perimeter at Post and Beam**

1:10 Options A and B

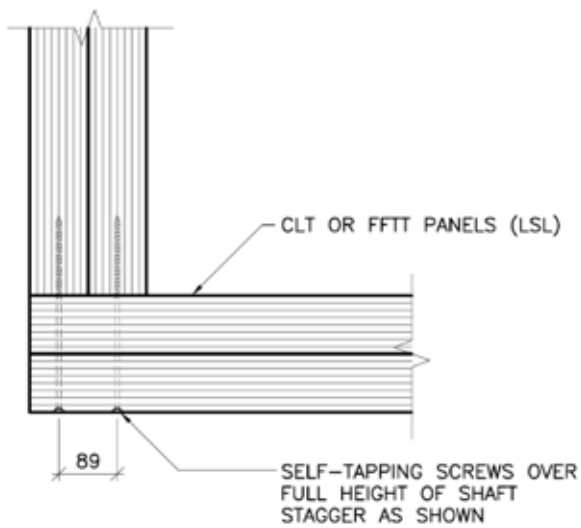

**Plan Detail - Typical Wall Intersection**

1:10

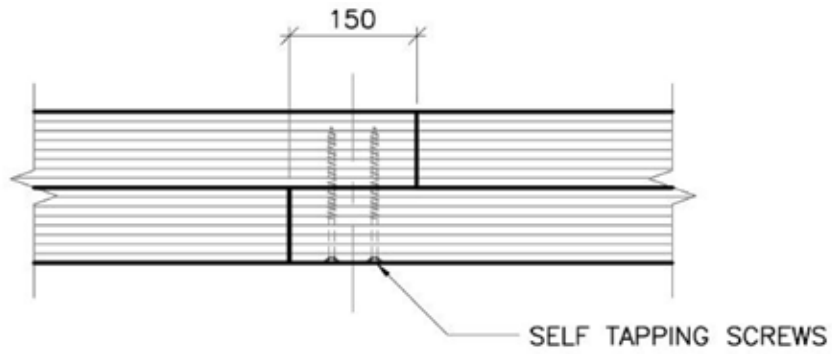

Plan Detail  
 Typical Vertical Joint  
 Double Panel (178 mm)  
 1:10

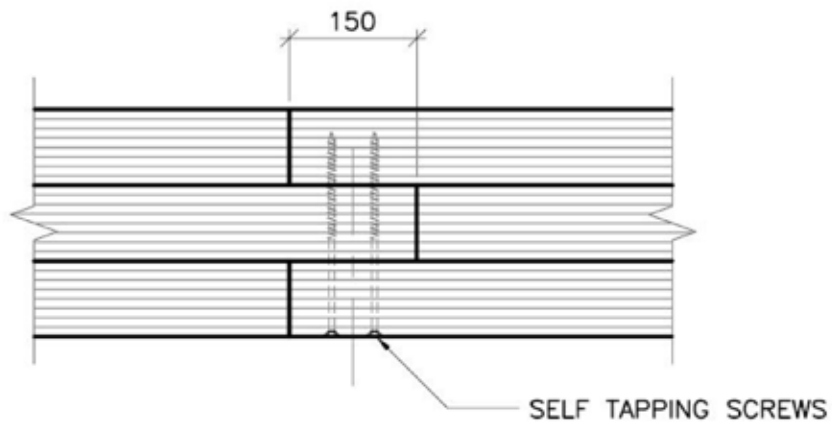

Plan Detail  
 Typical Vertical Joint  
 Triple Panel (267 mm)  
 1:10

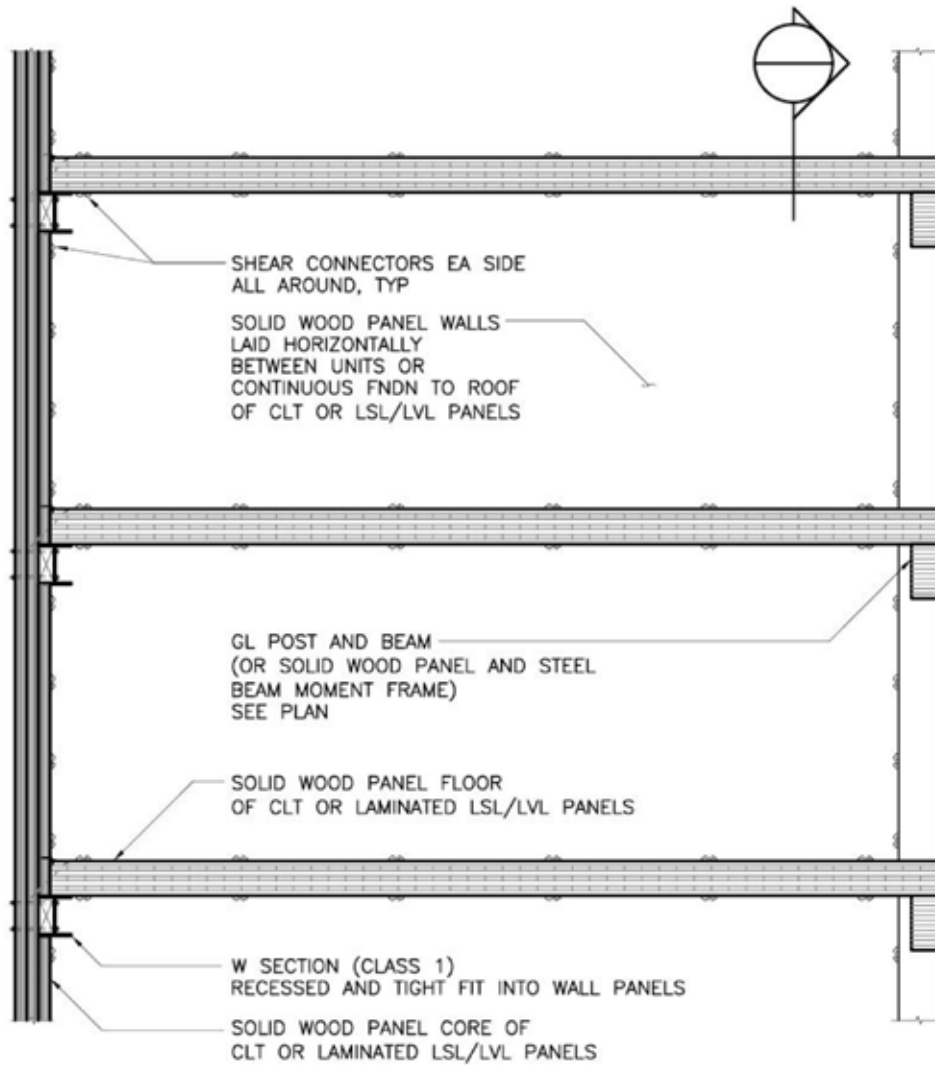

**Interior Demising Wall Elevation**

1:50 Intermittent or Continuous

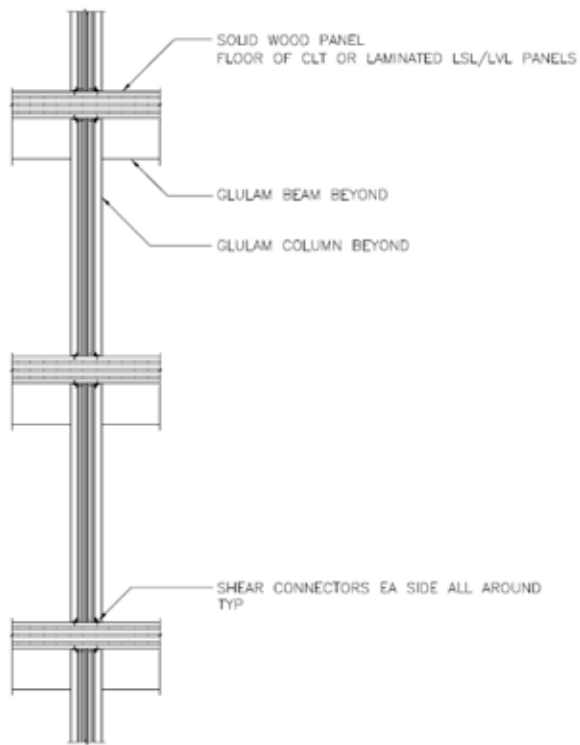

**Section - Intermitten Wall**  
1:50

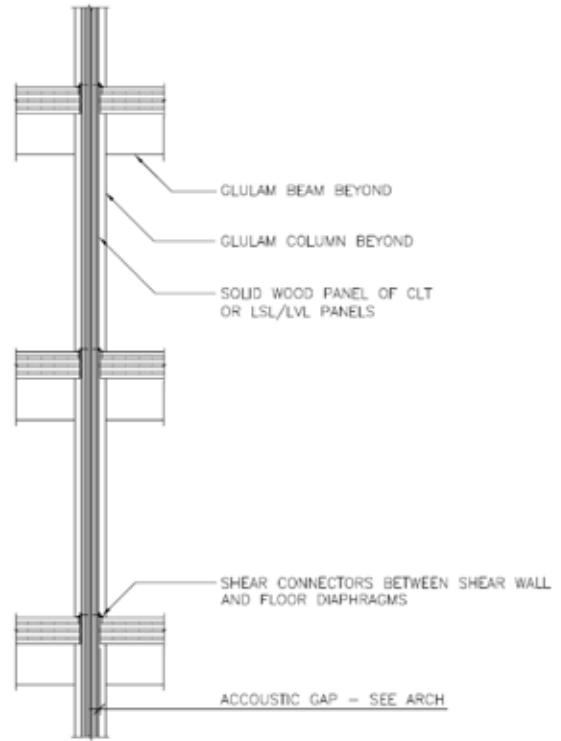

**Section - Continuous Demising Wall**  
1:50

## Erection

All timber elements will be pre-fabricated to sizes designed to optimize speed and ease of erection.

The header to panel connections will be simple and can be made on the ground to connect several panels together. These can then be “tilted up” several stories at a time. The core can be erected first, in pre-assembled lengths of 9.75m, and used to brace other walls and columns, which can be erected in lengths as high as 12m (for CLT’s) or 19.5m (for LSL and LVL).

Alternatively, the core can be pre-assembled on the ground and erected in 3 or 6 storey lifts, and the perimeter structure can be prefabricated in a shop with the envelope on and erected in one storey lifts.

Refer to the architectural report for a summary of contractor feedback, erection diagrams and additional construction related commentaries.

## Fire Resistance

Encapsulation is typically used to provide fire resistance rating to timber structures; however, charring is increasingly accepted around the world as a valid means of achieving reliable and safe structural performance in fire. Early tests at NRC and other facilities around the world have shown that solid wood panels perform very well in fire.

Combined with modern fire suppression systems and compartmentalization, structures can be detailed to safely resist fire without encapsulation using charring calculation methods. This eliminates the need for encapsulation, reducing building weight and cost while showcasing the natural beauty of the exposed timber.

## Design Loads

BCBC 2006 addresses fire loading in Paragraph 25 of Structural Commentary A, where the loading is:

$$D + T_s + (aL \text{ or } 0.25S)$$

**$a = 0.5$  for typical live load (or 1.0 where storage or equipment occurs)**

Eurocode 5 EN1995-2-1 provides a simplified method, whereby:

$$E_{d,fi} = n_{fi} E_d$$

**( $n_{fi}$  can be taken as 0.6) i.e. fire loading is 60% of the factored dead and imposed loading**

For the design loads in this study ( $D = 3.0$  kPa and  $L = 1.9$  kPa) the fire loading is essentially the same irrespective of the design approach used (3.96 vs 3.95 kPa).

## Material Strength Factor

Typically, material strength is multiplied by a factor of safety to account for variations in the strength of materials. In Canada, the typical factors used are 0.9 for steel, 0.65 for concrete and 0.8 – 0.9 for timber, reducing the strength of the material that can be assumed in design. As a result, the material actually used is very often stronger than that assumed for design; however, a small fraction will be of lower strength than that assumed in design.

For the low probability event of a fire, Eurocode 5 contains a factor that effectively increases the strength that can be assumed for the material. This is because: a fire occurring during the lifetime of a modern building is very unlikely; the strength of the material is unlikely to be below that assumed; the possibility of a) and b) in combination is exceedingly unlikely - for example a fire occurring in a compartment or building where the material strength is less than the assumed strength.

This factor is 1.15 for glulam members (and CLT) and 1.1 for LVL members. For conservative results at this stage, we have not allowed for this material strength increase in our computations.

## Structural Element Area Reduction

Timber elements exposed to a fire char at measured rates of 0.65mm/min (for CLT and LSL panels) and 0.635mm/min (for glulam elements). An additional ‘heated zone’ is assumed to provide negligible resistance to load – this is taken as 7mm, 10mm and 16mm for glulam, floor panels and wall panels, respectively.

In the analysis, column elements were exposed to fire on 3 sides; walls and floors to fire on 1 side. Based on the reduced load (60% of factored dead and live load), the capacity of the reduced-area structural elements was verified to determine what increases, if any, were necessary to carry the structural loads for a fire event. The tables below illustrate the thickness of structure removed by a 120-minute fire and the changes in section size necessary to safely accommodate this approach to fire safety design. It will be seen that minor increases to some column sizes were necessary; however, as a whole, the changes are minimal.

Refer to the charring diagrams for floor panels, wall panels and columns below. CLT panels have been used for the illustration as they are the worst case scenario due to the cross laminations, which are assumed to have zero cross grain capacity.

### Structural Element Area Reduction

Timber elements exposed to a fire char at measured rates of 0.65mm/min (for CLT and LSL panels) and 0.635mm/min (for glulam elements). An additional 'heated zone' is assumed to provide negligible resistance to load – this is taken as 7mm, 10mm and 16mm for glulam, floor panels and wall panels, respectively.

In the analysis, column elements were exposed to fire on 3 sides; walls and floors to fire on 1 side. Based on the reduced load (60% of factored dead and live load), the capacity of the reduced-area structural elements was verified to determine what increases, if any, were necessary to carry the structural loads for a fire event. The tables below illustrate the thickness of structure removed by a 120-minute fire and the changes in section size necessary to safely accommodate this approach to fire safety design. It will be seen that minor increases to some column sizes were necessary; however, as a whole, the changes are minimal.

Refer to the charring diagrams for floor panels, wall panels and columns below. CLT panels have been used for the illustration as they are the worst case scenario due to the cross laminations, which are assumed to have zero cross grain capacity.

### Char Depth and Heat Zone

	$d_{heat}$	$t$	$\beta$	$d_{char}$	total
	mm	min	mm/min	mm	mm
<b>CLT Floor Panel</b> <sup>[1]</sup>	10	120	0.65	78	88
<b>CLT Wall Panel</b> <sup>[1]</sup>	16	120	0.65	78	94

	$k_0$	$d_0$	$t$	$\beta_n$	$d_{char,n}$	$d_{ef}$
		mm	min	mm/min	mm	mm
<b>Glulam Element</b> <sup>[2]</sup>	1.0	7	120	0.635	76	83

<sup>[1]</sup> Based on FPIInnovations CLT Handbook 2011, Chapter 8 – Fire

<sup>[2]</sup> Based on Eurocode 5 - EN1995-2-1, Design of Timber Structures, General Rules - Structural Fire Design

**Changes to structural elements for 120-minute exposed fire rating**

<i>Option</i>	<i>Changes required</i>	<i>Protected</i>	<i>Exposed</i>	<i>Comments</i>
<b>Option A – 12-Storey Core</b>				
	Column size increase (GrL 2 & 3)	315x304	315x365	L00 to L08 only
	Perimeter column size increase (GrL 2 & 3, A & D)	315x304	315x415	L00 to L08 only
<b>Option B – 20-Storey Core &amp; Internal Walls</b>				
	No change			
<b>Option C – 20-Storey Core &amp; Perimeter Walls</b>				
	Column size increase (GrL 2 & 3, B & C)	415x406	415x465	L00 to L08 only
<b>Option D – 30-Storey Core, Internal Walls &amp; Perimeter Wall</b>				
	No change			



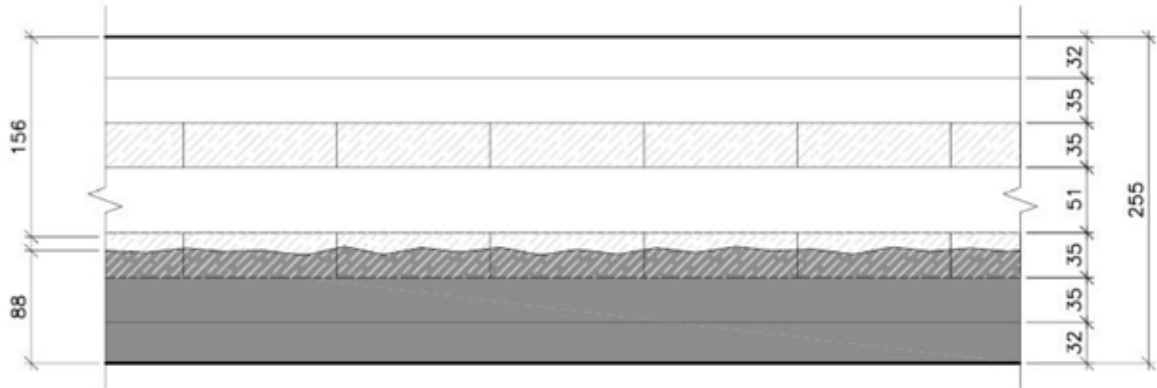

**Design Charring - CLT Floor Slab - Option 1**  
1:5

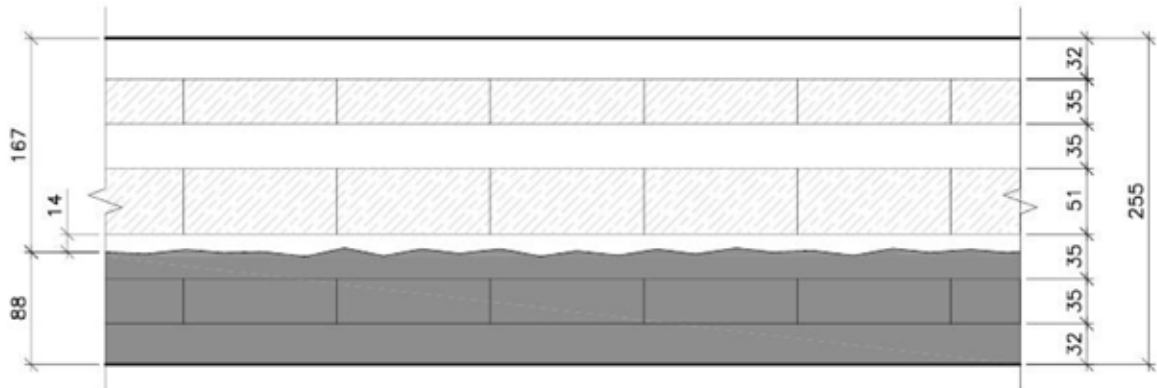

**Design Charring - CLT Floor Slab - Option 2**  
1:5

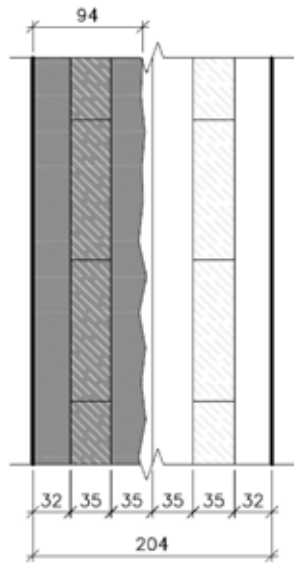

**Design Charring - 204mm Shear Wall**  
1:5

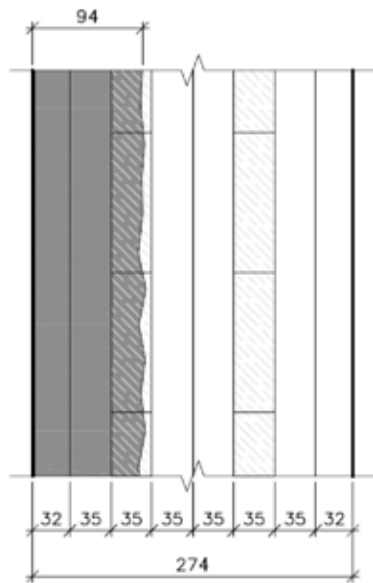

**Design Charring - 274mm Shear Wall**  
1:5

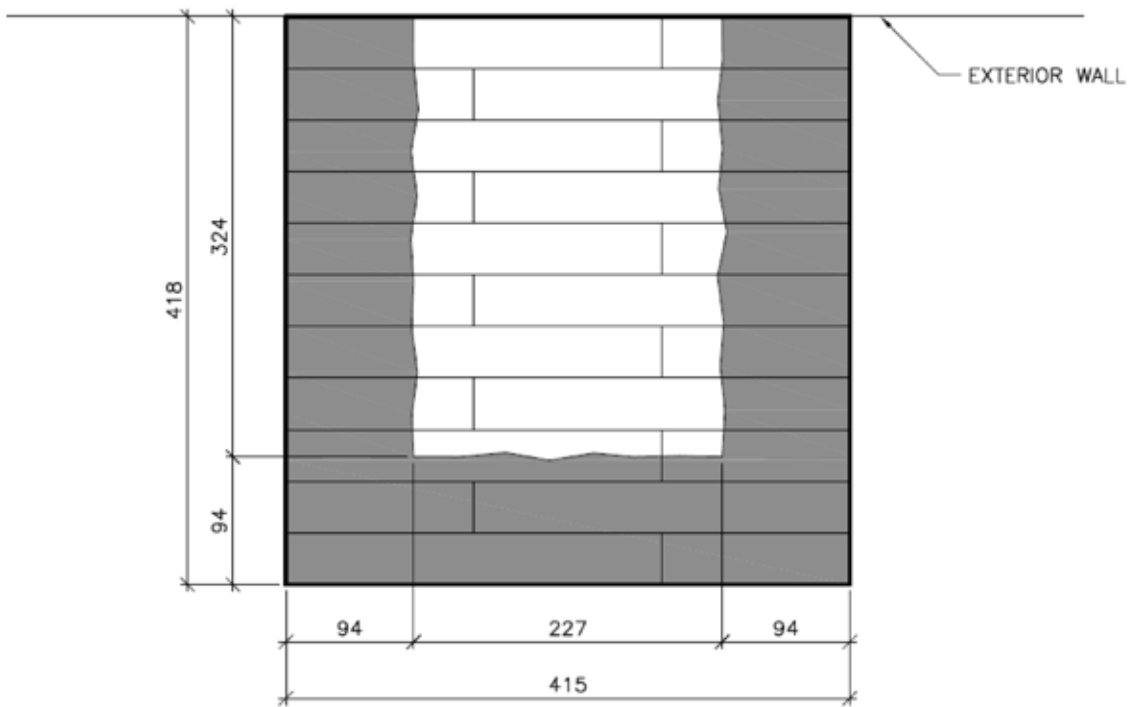

**Design Charring - Glulam Column**  
**Exposed on 3 sides**  
 1:5

## **Conclusion**

Based on our case study and preliminary analysis, using the Vancouver load case, it is our opinion that solid wood panel structures of 12 to 15 storeys can be practically and economically constructed with wood core construction alone and that structures of 30 storeys or more can be achieved practically and economically with a combination of lateral load resisting systems.

## **Appendix A**

See Appendix A for structural details including the concrete benchmark details, option frame layouts, deflection outputs and analysis report.

### 3.7 Fire Performance

The following is a summary of the building code requirements for the proposed mass timber system approaches being considered. It is noted that the proposed building design will be primarily of Residential (Group C) major occupancy with an assumed building height of between 12-30 storeys. Therefore, the subject building designs will be classified under the “high building” requirements of Subsection 3.2.6., with the additional measures for high buildings considered to be incorporated in the Project design (i.e., complete sprinkler protection with fire booster pump, firefighters’s elevator, emergency generator for 2-hour back-up power supply, full fire alarm system with CACF & voice communication systems and 2-hour protection of emergency electrical conductors). In all respects, the proposed Tall Wood Building case study will comply with the applicable requirements of the local building code within the jurisdiction of the City of Vancouver (VBBL 2007), with the exception that mass timber systems will be utilized as the structural framework for the building.

#### Project Characteristics Summary

Project Characteristics Summary Table	
Applicable Part of Division B:	3
Number of Buildings:	1; no firewalls
Building Area:	Approx. 500 m <sup>2</sup>
Building Height:	12-30 storeys
Number of Streets Facing:	1
Sprinklered:	Yes - per NFPA 13 (and additional sprinkler criteria outlined in this report)
Major Occupancies:	Group C residential (above-grade dwelling units) Group F3 Industrial (below-grade parking)
Article:	3.2.2.42. (Group C), Any Height, Any Area, Sprinklered) - see below for details
Construction Type:	Noncombustible prescribed (mass timber system “alternative” proposed) Fire assemblies and supporting structures to have 2-hour fire-resistance rating (floors constructed as “fire separations”)
Highrise Requirements:	Applicable - > 18 m and therefore, in accordance with Sentence 3.2.6.1.(1), the Project is a “high building”

#### Intent of Applicable Building Code Requirements

Relative to the fundamental structural fire protection and construction requirements of the building code, the objectives and functional statements from Division B - Table 3.9.1.1. that are applicable to the code requirements noted above are as follows:

Code Requirement	Objectives and Functional Statements
3.1.5.1.(1) Non-combustible materials	[F02-OP1.2], [F02-OS1.2]
3.2.2.42. (2) Group C, Any Height, Any Area	[F02-OP1.2], [F02-OS1.2] applies to the portion of the Code text:”... the building referred to in Sentence (1) shall be of non-combustible construction...”

Based on the breakdown of the applicable objective and functional statements applicable to the noncombustible requirements of the applicable building code sections, it is noted that the important statements relative to “non combustibility” of building construction are [F02-OP1.2] and [F02-OS1.2]. The detailed descriptions of the applicable objective and functional statements from Division A are as follows:

Objectives and Functional Statements	Description
F02	To limit the severity and effects of fire and explosions
OP1.2	To limit the probability that, as a result of it’s design or construction, the building will be exposed to an unacceptable risk of damage due to fire addressed in this Code are those caused by fire or explosion impacting area beyond its point of origin.
OS1.2	To limit the probability that, as a result of the design or construction of the building, a person in or adjacent to the building will be exposed to an unacceptable risk of injury due to fire. The risks of injury due to fire addressed in this Code are those caused by fire or explosion impacting areas beyond its point of origin.

### **Analysis of Objective and Functional Statements**

The functional and objective statements noted-above are intended to limit the probability that construction materials will contribute to the growth and spread of fire, which could lead to significant damage to the building and/or unacceptable harm to persons. Also the functional and objective statements noted state that materials, assemblies of materials and structural members required to have a fire-resistance rating are intended to protect people and the building from fire or explosion progressing through the building, and prevent collapse of structural and non structural members which could injure people or damage the building beyond the area of origin.

Subsection 3.2.2. requires non-combustible construction and specific fire-resistance ratings for various occupancies within buildings of varying heights and areas (i.e., 2-hour ratings and non-combustible construction for this project). These requirements relate the anticipated fire load in the various occupancies to the size of the building (area and building height), location of the building (relative to streets/principal entrances) and type of occupants expected in the building. The intent of the structural fire protection requirements outlined in Subsection 3.2.2. is to minimize the possibility of collapse, due to fire exposure, of floor or roof assemblies, for a sufficient time to allow occupants to move to a place of safety and to allow fire fighting operations to commence within the building.

It is the objective of this study to demonstrate in principle, that a high building constructed of mass timber systems, can not only provide the required 2-hour fire-resistance rating for a building of this height and occupancy, but also achieve the level of fire safety and performance that are attributed from the above-referenced functional and objective statements. That is, although the building is required to be of “non-combustible construction” in accordance with the applicable building code requirements, an equal level of fire performance and occupant safety can be provided, utilizing mass timber systems as the principal construction material and method. These construction systems and other active/passive protection measures to be incorporated in the building, will be designed to meet the appropriate functional and objective statements of the applicable building code requirements (as referenced above), in order to deliver a tall wood building design that will provide an equal level of performance to the building code requirements, as further outlined below.

## Review of Fire Performance Methodologies

There are fundamentally two different approaches that can be taken towards demonstrating sufficient fire performance of a mass timber structural system; a “charring” approach where the mass timber panels or systems may be exposed within the building, and an “encapsulation” approach where the mass timber panels are covered with conventional membrane systems (gypsum board). Although it is technically feasible to incorporate exposed wood timber panels in the building design based on a charring analysis approach, this approach will require further research and development (fire testing of mass timber panels and connection details in exposed state) before it is permitted with confidence on any high building designs. In the long-term, as sustainability objectives for building designs increase, exposed mass timber systems will gain more momentum and recognition as a truly “green” and safe building system, but in the shorter term, it is felt that an exposed timber system would be used to a limited extent and the majority of the mass timber panel systems (and associated structural elements) will be encapsulated or protected with conventional fire-rated gypsum board materials.

### Light Frame Construction vs Heavy Timber Construction Under Fire Exposure

In light wood frame construction, the structural components are typically composed of dimensional lumber such as 2x4, 2x6 etc. The relatively small size of these wood members makes them extremely susceptible to collapse in a fire. Typically, these smaller members will be fully engulfed and quickly burned by fire causing structural collapse. Thus, in light wood construction, the structure is normally protected from fire by using a fire resistant membrane layer such as gypsum board.

Although timber is considered a combustible material, heavy timber structures have been recognized as having good performance in fire due to the fact that there is a sufficient mass of wood that a char layer can form (incomplete combustion) that helps retard heat penetration.

### Charring of Heavy Timber

Charring is a process whereby when exposed to flame the outer layer of wood reaches its burning point, ignites and burns. In this chemical reaction, the heat removes hydrogen and oxygen from the solid wood, leaving a layer of char that is now mainly composed of carbon. This char layer has low conductivity which results in a sharp thermal gradient across the char layer. Beyond the char layer, a layer known as the pyrolysis zone forms, where the rise in temperature of the char layer causes decomposition of the wood in this zone. The inner core is only slightly affected by the temperature rise resulting mainly in moisture loss.

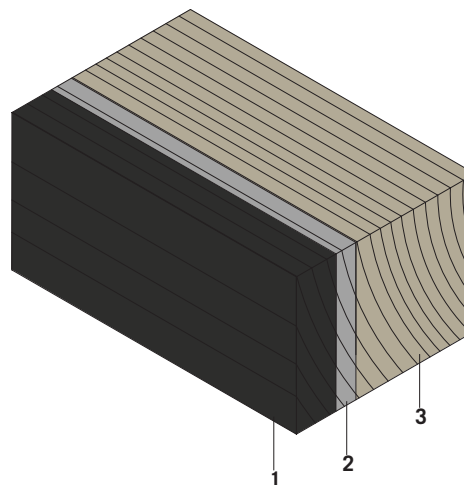

### Charring Diagram

- 1 Char layer
- 2 Pyrolysis zone
- 3 Normal wood

### Charring Rates

Timber elements exposed to a fire char at measured rates of 0.65mm/min (for CLT and LSL panels) and 0.635mm/min (for glulam elements). An additional ‘pyrolysis zone’ is assumed to provide negligible resistance to load – this is taken as 7mm, 10mm and 16mm for glulam, floor panels and wall panels, respectively. Source: FP Innovations CLT Handbook 2011

#### Char depth + heat zone

	$d_{char}$ mm	$t$ min	$\beta$ mm/min	$d_{char}$ mm	total mm
CLT Floor Panel <sup>[1]</sup>	10	120	0.65	78	88
CLT Wall Panel <sup>[1]</sup>	16	120	0.65	78	94

	$k_0$	$d_0$ mm	$t$ min	$\beta_0$ mm/min	$d_{char,0}$ mm	$d_{ch}$ mm
Glulam Element <sup>[2]</sup>	1.0	7	120	0.635	76	83

<sup>[1]</sup> Based on FPInnovations CLT Handbook 2011, Chapter 8 – Fire

<sup>[2]</sup> Based on Eurocode 5 - EN1995-2-1, Design of Timber Structures, General Rules - Structural Fire Design

The fire-resistance rating of large-sized members can be calculated, based on minimum structural thicknesses and the remaining sacrificial thickness available for charring. This fire safety design approach is of particular interest as it is consistent with the technical analysis of mass timber structures being done in Europe and would ultimately facilitate a truly expressed/exposed wood design in a tall wood building. However, it is expected that this approach may encounter less certainty and more stringent levels of review by approving Authorities Having Jurisdiction, based on the “performance-based” nature of the fire safety design and reliance on detailed calculation methods, fire modelling analysis and other factors.

Mass timber construction is beneficial from a fire performance perspective since the wood itself can provide the necessary fire-resistance to support the imposed dead/live loads on the structural assemblies both during and after a fire condition, and do not have to rely on additional thermal membrane protection in all cases to achieve this. It is noted that where mass timber panels are used for floor assemblies and “drop-ceilings” are installed below, a combustible concealed space condition will result. These concealed spaces can be addressed with the use of gypsum-board protection of the wood surfaces within the void spaces, or the installation of automatic sprinklers as required by NFPA 13. However, in general it is recommended that combustible void spaces be avoided as much as possible in the Tall Wood Building designs.

## Charring Rate

Charring rate is the rate at which a wood member will burn away when exposed to fire over time. This charring rate depends on numerous factors such as timber type, its density, tree species, adhesives, moisture content and structural forces acting upon it, as well as the properties of the fire itself.

Timber elements exposed to a fire char at measured rates of 0.65mm/min (for CLT and LSL panels) and 0.65mm/min (for glulam elements). An additional ‘pyrolysis zone’ is assumed to provide negligible resistance to load – this is taken as 7mm, 10mm and 16mm for glulam, floor panels and wall panels, respectively. See section 3.6 for design specific structural analysis of charring and impact on material thickness specification.

The measured rates of potential fire exposure are considered a “worst-case” scenario in real world conditions, due to the fact that in most fire conditions the sprinkler system would operate to control temperatures/fire development within the compartment of origin, which would further minimize the fire impact on the underside of the mass timber floor assembly. In addition, it is expected that fire department resources would be dispatched and operational to suppress the fire condition well before the 2-hour fire duration is achieved.

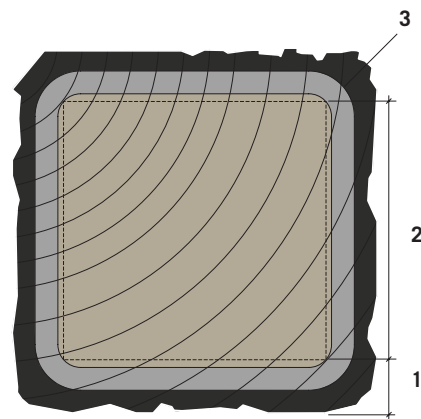

**Charring Structural Design Diagram**

- 1 Sacrificial layer (char layer and pyrolysis zone; no structural capacity)
- 2 Residual section (structural capacity retained)
- 3 Rounded corner



## **Structural Design and Capacity of Charring Heavy Timber**

It is widely recognized that heavy timber members that have been damaged by fire still retain structural capacity in the non-charred section or residual section. It is accepted that the charred portion has no structural strength. Using this principle as a basis for design, heavy timber structural members can be designed to have a sacrificial layer of wood that would act as a fire protection layer. Using tested charring rates, the thickness of this sacrificial layer can be determined to give the appropriate fire resistance rating necessary to protect the structure from collapse and sufficient time for occupants to exit the building.

Assuming that the sacrificial layer of wood is burned away but the remaining wood is of sufficient capacity to support the imposed dead/live loads of the floor assembly above, the mass timber floor assembly would meet the performance objectives for fire safety and structural stability. Schaffer indicates that fire resistance testing of heavy timber type construction of specified minimum dimensions, is considered “equivalent to or better than other types of construction having a 1-hour fire endurance.” (Schaffer 1984) Studies of material properties have also shown that at the piloted ignition temperature of wood timber (approximately 350°C), structural steel would begin to lose strength, and at a critical temperature of 550°C, the steel will be reduced to approximately 60% of its original strength, with further reductions in strength as the temperature rises. In fact, Schaffer draws a comparison between the critical temperature for loss of strength in steel (550°C) and the temperature at which the demarcation between charred and uncharred wood occurs as a result of fire exposure. (Schaffer 1984) Consequently, it is concluded that wood timbers and other heavy timber wood elements will perform equal to or better than structural steel under fire conditions.

## **Fire Resistance Rating and Compartmentalization**

Fire resistance is a measure of a building assembly's ability to resist the effects of heat and fire on a construction assembly or building material when exposed to fire under specified conditions of test for a determined fire duration, as well as for a loading bearing structures to continue to carry loads without collapsing or excessive deflection when exposed to fire. In the case of non-load bearing assemblies, the fire resistance is based on its fire separating function and its ability to maintain integrity (self-supporting). The fire resistance rating (FRR) of a building assembly has been typically assessed by standardized tests CAN/

ULC S101 in Canada and ASTM E119 in the United States and ISO 834 in many other countries. By containing the spread of a fire and protecting its structure, occupants are given time to exit the building and fire fighters time to prevent further property loss.

Standardized fire testing of mass timber material assemblies will be beneficial to gain further confidence and technical information towards the use of this technology in the future. In the meantime, other analytical calculation techniques including charring rate calculations (in conjunction with dynamic structural analysis during fire conditions) and computerized fire modeling applications, can be used to determine the fire-resistance performance of the material assemblies to be used for this Project.

It is also noted that one of the positive characteristics of the TWB project design, is the level of compartmentalization that will be realized in the completed project. That is, each floor area will be sub-divided into small residential suite “fire compartments” that will limit the potential spread of fire and development beyond the compartment of origin, with the rated floor/wall construction around the boundary. In conjunction with automatic “fast-response” residential type sprinkler protection in each fire compartment, the likelihood of a potential fire condition developing beyond the compartment of origin will be negligible. This design arrangement will assist in meeting one of the fundamental Code objectives of Article 3.2.2.42. – OP 1.2/OS 1.2 limiting the probability of damage or injury due to fire spread impacting areas beyond the point of origin.

## **Flammability and Interior Finishes: Flame Spread Rating and Smoke Developed Classification**

While fire resistance assemblies prevent the spread of heat and fire from passing from one compartment to another they do not consider flame spread and smoke development. Since heavy timber is still a combustible material, there will be an amount of smoke and heat generated when exposed to fire. Of particular concern would be exit corridors and exit shafts where smoke, flames and other toxic gases generated by combustibles can spread and compromise exiting facilities. Consequently, these areas of the building will typically be protected with gypsum board or other noncombustible finish materials to meet the applicable building code requirements.

The spread of flames and smoke for material assemblies is also governed by the building code and are referred to as Flame-Spread Rating (FSR) and Smoke Developed Classification (SDC). However, it is noted that the flame-spread rating and other surface burning requirements of the Code are intended to be applicable to the interior finish materials that form part of the interior surface of a floor, wall, partition or ceiling, including such elements as: interior claddings; surfacing of fabric, paint, veneer, etc.; doors, windows, trim; lighting elements such as light diffusers/lenses; and carpet material that overlays a floor.

Generally, these interior finish materials are thin surface or veneer treatments that are applied to or overlaid onto a base substrate material, and which, due to their combustibility or other material properties, may represent an increased fire hazard within an interior compartment of a building. Due to the massive, solid wood nature of mass timber construction, the surface burning characteristics of the solid wood panels will be substantially different.

#### **Flame Spread and Smoke Developed Indices in High Buildings**

Section 3.1.13.7 (1) provides a specific “relaxation” for sprinklered buildings, whereby the more stringent FSR/SDC ratings of the Code are waived in sprinklered floor areas of high buildings. Therefore, it is noted that where mass timber systems are proposed to be used in an exposed installation, the surface burning characteristics of the wood materials is not intended to be augmented through “fire-retardant treatments” or other chemical applications, since the fire compartments in which they are exposed will be fully sprinklered. Further, since the exposed wood surfaces will form part of a solid mass timber panel system (as opposed to a thin interior finish or lining material that these Code requirements are intended to regulate), the wood surfaces will not be as readily ignitable and will not sustain surface combustion in the same manner as thin/low mass interior finish materials.

**Table: Flame Spread Indices of Wood Products**

Wood Material	Flame Spread Index	
Yellow Poplar Lumber	185	<b>Class C</b>
Douglas Fir Plywood	155	
Walnut Lumber	140	
Oriented Strand Board	138	
Yellow Birch Lumber	110	
Southern Pine Plywood	110	
Maple Lumber	104	
Douglas Fir Lumber	100	
Red or White Oak Lumber	100	
Eastern White Pine Lumber	85	
Western White Pine Lumber	75	<b>Class B</b>
Red Cedar Lumber	73	
Redwood Lumber	70	
White Fir Lumber	65	
Fire Retardant Treated Lumber Plywood	< 25	<b>Class A</b>

(American Wood Council 2006)

**Table: Smoke Developed Indices of Wood Products**

Wood Material (Lumber 1" Nominal Thickness)	Smoke Developed Index
Red Pine	229
Lodgepole Pine	210
Maple flooring	157
Eastern White Pine	122
Red Oak Flooring	100
Redwood	75-115
Western Red Cedar	98
Douglas Fir (Pseudotsuga menziesii)	54

(USDA, Forest Service 2010)

**Applicable Building Code Excerpts for Flame-Spread Rating and Smoke Developed Classification for High Buildings**

**3.1.13.7. High Buildings**

1) Except as permitted by Sentences (2) to (4), the interior wall, ceiling and floor finishes in a building regulated by the provisions of subsection 3.2.6. shall conform to the flame-spread rating requirements in Article 3.1.13.2 and to the flame-spread rating and smoke developed classification values in Table 3.1.13.7.

<b>Table 3.1.13.7 Flame-Spread Rating and Smoke Developed Classification in a High Building</b>						
Location or Element	Maximum Flame-Spread Rating			Maximum Smoke Developed		
	Wall Surface	Ceiling Surface(1)	Wall Surface	Wall Surface	Ceiling Surface(1)	Wall Surface
Exit stairways, vestibules to exit stairs and lobbies described in Sentence 3.4.4.2.(2)	25	25	25	50	50	50
Corridors not within suites	(2)	(2)	300	100	50	500
Elevator cars and vestibules	25	25	300	100	100	300
Service spaces and service rooms	25	25	25	50	50	50
Other locations and elements	(2)	(2)	No Limit	300	50	No Limit

Notes to Table 3.1.13.7.

(1) See Article 3.1.13.4. for lighting elements

(2) Other requirements of this Part apply

(British Columbia Building Code 2006) Division B - Part 3

## Encapsulation Approach

The alternate approach to ensuring adequate fire performance of the mass timber assemblies, is to utilize an encapsulation method which is similar to standard construction techniques used to construct fire-rated floor, roof and wall assemblies in both combustible and noncombustible building types. This approach is concluded to be highly feasible and acceptable as a means of addressing the applicable Code requirements from a designers, builders and Code authorities perspective, whereby the solid wood members are protected with 2 layers of fire-rated gypsum board within each compartment and generally throughout the building.

The encapsulation approach would incorporate the installation of 2-layers of 16 mm type X gypsum board directly to the exposed surfaces of the mass timber materials, using positive fastening devices (i.e., screws) of sufficient depth to resist deterioration and pull-out during fire exposure. The resulting floor and wall assemblies are expected to achieve the required 2-hour fire resistance ratings based on similar ULC listed fire-tested assemblies incorporating gypsum board protection of light wood or steel construction, and the cumulative assembly rating information contained in Appendix D of the BC Building Code.

As with typical drywall finished construction techniques, gypsum board layers would incorporate staggered, overlapping joints to maintain solid continuous thermal protection of the underlying wood substrates. Other benefits of this approach would include the fact that no combustible void or concealed spaces would be created in the mass timber construction, due to the presence of GWB on all surfaces within ceiling spaces, shaft areas, etc. The finished gypsum board surfaces providing protection of the mass timber structural elements of the building, may also perform as the interior room finishes for the individual residential dwelling units (for high ceiling areas with no drops and wall finishes). Therefore, specific instructions and information would need to be distributed to the individual building owners, to caution them on altering or damaging the ceiling/wall finishes in the suite. Other “serviced” areas of the suites would incorporate suspended ceiling “dropped” areas (as per architectural details) with space to house electrical/mechanical/plumbing services within and avoid openings/penetrations of the fire-rated mass timber system as a benefit of this design approach. Where these concealed spaces exist, the horizontal timber panel would either be protected with gypsum board membranes or the concealed space would be provided with sprinkler protection.”

## Exterior Cladding and Balcony Details

The fire-rated mass timber system approaches would apply to all of the interior/exterior load-bearing structural elements of the proposed building, including interior floor assemblies, interior/exterior load-bearing walls and other structural columns, beams, posts that are supporting the dead/live loads imposed by the building and it’s occupants. One exception to the above will be the exterior balcony assemblies, which are permitted to be “unrated” elements on the exterior of the building by the applicable building code requirements, and due to conflicts with building envelope/ventilation detailing are problematic to provide a fire-rating to the underside. It is noted that the all exterior balcony areas of the building will be sprinkler protected (using dry sidewall type sprinklers) and the underside of the balcony assemblies will be finished with a ventilated noncombustible cladding material (i.e., cementitious panels system). The exterior cladding system providing the building envelope for the Tall Wood Building design, will entail a ventilated “rain-screen” exterior wall system, utilizing noncombustible cladding and components (including exterior insulation materials) in order to minimize the potential for vertical fire spread on the building façade via exterior window openings.

## Scissor Stair Design and Protection of Connection Hardware

The proposed building designs incorporate two options for meeting the exiting requirements of the building code; a 2 stair shaft design with separate exit stair facilities located in 2 separate exit shafts constructed of vertical mass timber panels, and a 2 stair shaft design with separate exit stair facilities located in a “scissor stair” design of hybrid mass timber/concrete construction. Refer to Core Plan and Stair Detail drawings for further details of each configuration. While the 2 separate exit shaft design will be feasible from a constructability and safety perspective, the possible scissor stair design requires further analysis and development relative to connection details, continuity/integrity of fire separations between separate stair compartments, and provision of rated firestopping systems that will prevent the passage of smoke at gaps/joints between the scissor stair components. For the scissor stair design to be acceptable in the City of Vancouver, all of the above factors must be addressed at the design phase of the Project, as the City has indicated that scissor stair designs in wood-frame buildings will not be permitted without full resolution of the design details in advance of construction. In addition, the City of Vancouver and most other municipalities require a full “smoke test” of the scissor stair construction prior to Occupancy of a building, in order to demonstrate that each exit stair is “smoke tight” from the other.

Another concern and detail that will require further analysis/review relative to fire performance of the mass timber systems, is the detailing and protection of the timber connection hardware that is used to tie the building structural panels and systems together. Using the “encapsulation approach” to fire-rating the mass timber structures, the connection plates will typically be protected within depth of the protected assemblies or wood materials. However, where the connection plates may be exposed or vulnerable to the effect of fire, and perform a critical load-bearing capacity in the structural design of the building, these connectors will need additional fire protection in the form of intumescent coatings or similar applied fire protection products.

### **Enhanced Sprinkler System Design – Benefits of Automatic Sprinklers**

For either of the fire-rated mass timber approaches (exposed charring or encapsulation), an enhanced sprinkler system design based on the requirements of NFPA 13, is proposed such that a complete and high-reliability automatic fire suppression system will be available in the building. The following points summarize the proposed enhanced sprinkler system design:

- › Installation of fast-response residential type sprinkler heads in all fire compartments, rooms, closets, exterior balconies, spaces, etc. throughout the entire building with no exceptions for unsprinklered compartments. This feature will mitigate the possibility of a fire developing in a small non-sprinklered space and spreading to other areas of the building.
- › All exterior occupied spaces such as balconies, ground level patios with building overhangs above, and similar exterior spaces will be sprinkler protected to minimize potential fire ignition and vertical spread on the building exterior.
- › In order to provide an improved degree of seismic safety and reliability in the sprinkler/standpipe system design, the building will be typically provided with a 2 vertical standpipe system (one in each exit stair) and this standpipe system will be “looped” within the building such that if one part of the water supply system becomes severed or impaired, the fire department will still have the ability to pump into the system and boost the pressure to the sprinkler/standpipe systems. Manual isolation valves will be installed in strategic, accessible locations for isolation of the overall fire protection system during such an emergency condition as necessary.
- › All control and isolation valves serving the entire fire protection system, including the main shut-off valve on the City street supply will be electrically supervised and monitored by the building fire alarm system, in order to avoid the possibility of a critical valve being closed and thus, impairing the water supply to the entire building.

The proposed enhancements to the base sprinkler system for the building are intended to provide a complete and high-reliability automatic fire suppression system for the entire building, such that the potential for fire exposure of the mass timber systems will be of minimal effect, due to the well documented cooling and suppression benefits of automatic sprinkler protection. Other enhancements proposed for the base fire suppression systems are intended to provide a higher degree of reliability for firefighters operating within the building, during a fire incident or other “post-disaster” scenarios (i.e., seismic event).

### **Enhanced Fire Detection Design – Exposed Timber Applications**

For the potential exposed timber panel designs, using a charring analysis approach for determining the structural fire-resistance rating of the building, there is a concern that fire exposure of the exposed timber panels within an interior fire compartment may result in partial combustion, which in turn could produce quantities of smoke that could jeopardize occupants of the building (i.e., persons evacuating the building). It is intended by the design that the exposed timber elements would be typically located within the residential fire compartments of the building (i.e., not in the building common areas or exit systems) and therefore, the primary concern would be a developing fire from a dwelling unit area. The fire alarm technology is available to install “intelligent” smoke alarm/detector devices within each residential fire compartment, that would perform a two-fold function: one function would be activate as a conventional “smoke alarm” to sound an audible signal within the dwelling unit only (i.e., to alert/awake the occupants). The 2nd “enhanced” function of these devices would form part of the fire alarm system for the building, with these smoke detection devices initiating an “alarm” condition on the building fire alarm panel and throughout the building after a period of 5 minutes. The fire alarm system could also be programmed to initiate a fire department response signal after a pre-determined period of time, to investigate the cause of the alarm condition, and initiate manual fire suppression activities as necessary upon arrival. As an “addressable” type fire alarm system, the smoke detectors within suite could be utilized to pin-point the location of the fire detection initiation, such that firefighters will know the exact location of the fire alarm condition upon arrival.

## Diagrams

## Hybrid Charring and Encapsulation Details

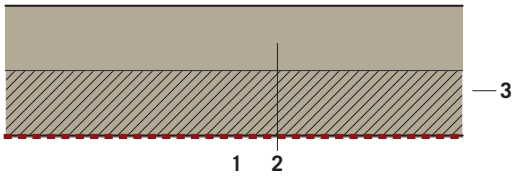

- 1 Fire exposed side
- 2 Mass timber structure
- 3 \*\*/\*\*Sacrificial mass timber layer (2HR FRR)

### Assembly illustrating charring only concept

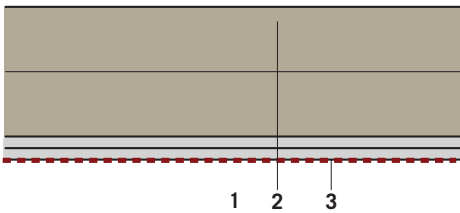

- 1 Fire exposed side
- 2 Mass timber structure
- 3 2 layer 5/8" type X gypsum board (2HR FRR)

### Assembly illustrating encapsulation only concept

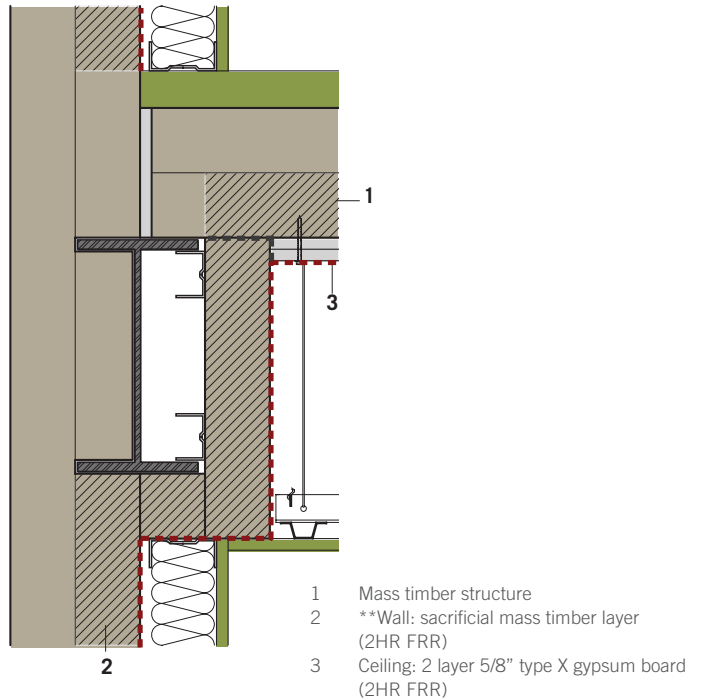

- 1 Mass timber structure
- 2 \*\*Wall: sacrificial mass timber layer (2HR FRR)
- 3 Ceiling: 2 layer 5/8" type X gypsum board (2HR FRR)

### Assembly illustrating hybrid charring and encapsulation concept

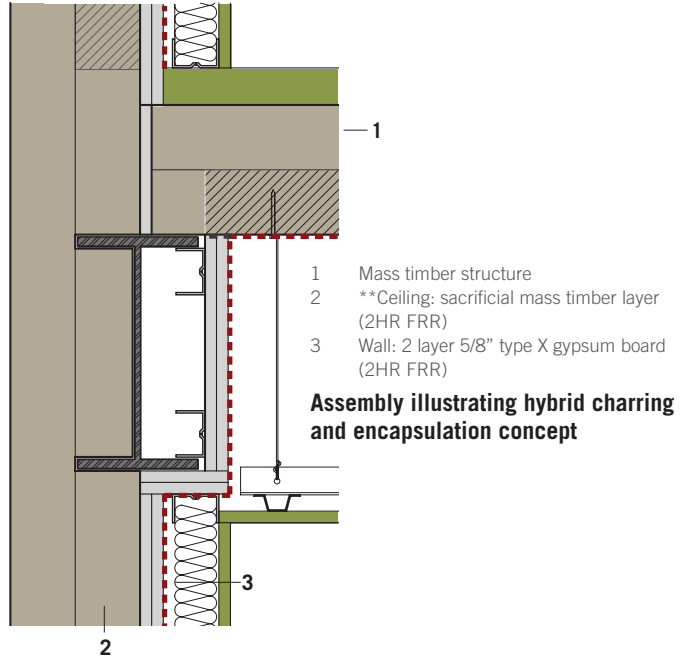

- 1 Mass timber structure
- 2 \*\*Ceiling: sacrificial mass timber layer (2HR FRR)
- 3 Wall: 2 layer 5/8" type X gypsum board (2HR FRR)

### Assembly illustrating hybrid charring and encapsulation concept

\*\*

Charring rates vary depending on moisture, density, species etc. The charring rate of 0.65mm/min is the generally accepted average. Refer to Section 3.7 Fire Performance for additional information on charring rate.

\*\*\*

Interior finish: exposed wood paneling subject to flame-spread rating and smoke developed classification code requirements. Refer to section 3.7 for additional information on flamespread, smoke classification and interior finishes.

\*\*\*\*

Sprinklers required in ceiling cavity if charring method is used.

## Fire Separation and Panel Joints

Since the study proposes the use of panel products (LVL, LSL, CLT) that are required to be joined at some instances, an important component of a fire protection strategy would be the integrity of the joints. These joints are vulnerable to leaks that would allow a fire to penetrate an assembly. Therefore, proper design is required to ensure an effective seal.

In the case of fire protection using encapsulation, the gypsum board should be attached directly to the wood panels so that it is tightly butted with no air cavity. For additional integrity and continuity, joints of the gypsum board can be staggered to the joints of the wood panels.

Where wood panels are used as a finished surface, or in the charring fire protection method, it is crucial that joints are sealed properly to prevent fire from breaching the assembly at a faster rate than anticipated during a fire. Some manufacturers provide tested details for such joints. However, further work and collaboration between designers, manufacturers and authorities is required to ensure joint details are sufficient to maintain the integrity of the given fire-rated assemblies. Moreover, these joints must be designed and reviewed in relation to the actual type of timber used, its structural function and required fire protection requirements.

### Typical Panel Joint Details

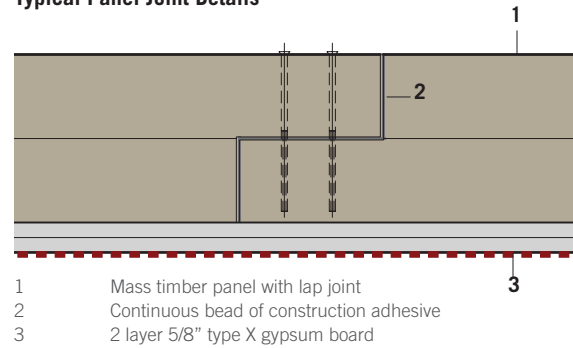

### Assembly illustrating encapsulation concept with lap joint

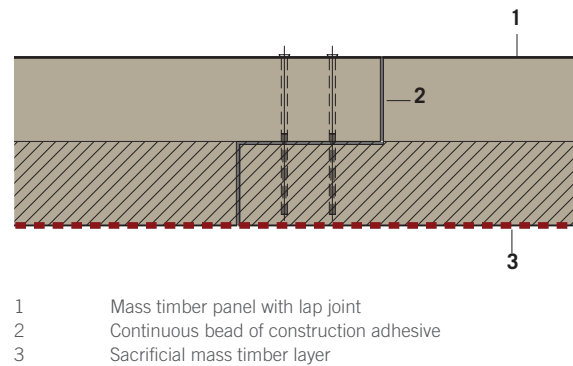

**Assemblies illustrating joints. Refer to Section 3.6 Structural Intent for additional information on joints.**



## Code Analysis

From a building code perspective, the main focus has been on the determination and delivering of an equivalent level of performance for a tall wood building constructed of engineered “mass timber” technology, as compared with a typical market apartment building of reinforced concrete construction. However, it is noted that the mass timber systems approach is feasible to use on other high building types typical of the downtown Vancouver area, including office buildings and potentially “mixed-use” type buildings incorporating a variety of live, work and shopping functions in one building. The introduction of other occupancy classifications would not fundamentally change the technical approaches to building code compliance utilizing mass timber systems, but would integrate appropriate fire protection and life safety features based on the specific occupancy hazards within each occupied area. There are fundamentally two main approaches to achieving the base-line Code requirements for fire-resistance of the mass timber structural elements: an “encapsulation” approach whereby the solid wood members are protected with 2 layers of fire-rated gypsum board within each compartment and generally throughout the building - this approach is seen as highly feasible and acceptable as a means of addressing the applicable Code requirements. The other design approach with respect to fire safety and fire-resistance of the structural mass timber elements, is that of a “charring rate” analysis, whereby the mass timber panels would be used as fully or partially exposed elements in the building design, and calculation methodologies for determining the rate of charring and subsequent reduction in structural capacity would be applied to determine the effective depth/thickness of wood required to achieve the required level of performance. This fire safety design approach is of particular interest as it is consistent with the technical analysis of mass timber structures being done in Europe and would ultimately facilitate a truly expressed/exposed wood design in a tall wood building. However, it is expected that this approach may encounter less certainty and more stringent levels of review by approving Authorities, based on the “performance-based” nature of the fire safety design and reliance on detailed calculation methods, fire modeling analysis and other factors.

A residential building greater than 18 m high is classified as a “high building” under the applicable Code requirements, and therefore is required to have minimum 2-hour rated floor/load-bearing wall assemblies, as well as being fully sprinkler protected. At the same time, the “objective-based” information of the Code that has been outlined in this report (and is used to develop Alternative Solutions), incorporates a functional statement to “limit the severity of the effects of fire” with “fire safety to occupants” and “fire protection of the building” as the main objectives relative to construction type.

It is these fundamental performance criteria that should be used to evolve and redevelop the traditional Code classification system (of combustible vs. non-combustible construction) into a modern Code format that ultimately considers all base construction materials on an even playing field (i.e., concrete, steel, wood, etc.). As summarized in this report, the fundamental fire protection and life safety objectives for a residential building greater than 18 m in height (high building classification) can be distilled as follows:

- › All floor assemblies and load-bearing elements to have minimum 2-hour fire-resistance rating (based on standard testing, or other analytical methods).
- › Building to be designed to limit the severity and effects of fire or explosions.
- › Building to be designed to limit the probability of unacceptable risk of injury of occupants caused by fire impacting areas beyond the point of origin.
- › Building to be designed to limit the probability of unacceptable risk of damage to building caused by fire impacting areas beyond the point of origin.
- › To provide for the safety of the occupants of a building, by maintaining the tenability of occupied floor spaces during a fire emergency, and by providing a means for all occupants of the fire floor to leave that floor quickly;
- › To maintain tenable conditions in exit stairs leading from floor spaces to the outdoors, and in spaces through which occupants have to pass or in which they remain while waiting for assistance to evacuate;
- › To maintain tenable conditions in elevators that are used to transport fire fighters and their equipment from the street floor to the floor immediately below the fire floor and for the evacuation of injured persons or persons with disabilities.

This type of “objective-based” language could be used as the basis for a future Code change proposal to the National Research Council of Canada, in order to permit the use of all materials for a proposed building design, including the possible use of mass timber structural systems for high buildings.

In conclusion, it is noted that a high building of residential occupancy can be feasibly designed and constructed to meet the above noted functional statements and fundamental safety objectives of the National Building Code of Canada, on a “performance-basis”, whether it be of concrete, steel or mass timber construction. As part of the technical research and interview process for this Project, it is noted that a successful presentation and discussion meeting with the City of Vancouver CBO and other senior technical staff was held on March 11th, 2011. During that meeting, it was concluded that the City staff were generally receptive/positive towards the information and technical details of the proposed Tall Wood Building study, and that such a building can be developed to meet the fundamental objectives of the applicable building code (VBBL 2007) on a “performance-basis”. It is interesting to note from this meeting, that the CBO indicated the “encapsulation” approach seemed “counter-sustainable” due to extensive use of gypsum board materials in the design, and suggested that more research should be done towards exposed mass timber designs as an ultimate sustainability objective for the design study.

## 3.8 Sound Performance

### Sound and Buildings

The passage of sound between units of a residential or commercial building, as well as from the outside in, plays a large role in the comfort level (and general happiness) of its occupants. There are two ways to measure the passage of sound, Sound Transmission Class and (STC) and Impact Insulation Class (IIC).

### Sound Transmission Class (STC)

Sound transmission can be defined as sound waves hitting one side of a partition causing the face of the partition to vibrate which re-radiates as sound on the other side.

Sound transmission class or STC, is a numerical rating assigned to a wall or floor assembly, used to describe how well it transmits sound. STC classifies the average noise reduction in decibels for sounds that pass through an assembly. A high STC rating for an assembly implies good sound attenuation characteristics. Loud or amplified speech and loud music would still be audible with an assembly that has an STC rating of 45. Whereas, loud music would be inaudible except for very strong bass notes in an assembly with a rating of STC 60. (Canadian Mortgage and Housing Corporation 2009)

The STC rating ignores low-frequency sound transmission below 125 Hz, which is often associated with mechanical systems, transportation noise and amplified music. Low-frequency sounds can be a major cause for complaint in multi-family construction. A heavier assembly with the same STC as a lighter assembly may often outperform the lighter assembly at low frequencies.

### Impact Insulation Class (IIC)

Impact sound is caused by a direct contact or impact on a floor or wall that vibrates the partition. This sound is then radiated in the cavity of the assembly which can then be transmitted into a space as sound.

The standard test for impact sound that results in a rating called "impact insulation class" (IIC). The standard test method uses a tapping machine that consists of a motor and turning shaft that lifts and drops five steel hammers on the floor a total of 10 times per second. Sound pressure levels are measured in the room below at specific frequencies.

IIC increases as the impact sound insulation improves. The building code does not outline acceptable IIC ratings for walls or floors but recommends an IIC of 55. In practice, this is deemed largely ineffective and levels of IIC 70 are necessary for residential applications.

### Flanking Sound

Flanking noise refers to when sound vibrations are transmitted through an assembly by moving across its top, bottom or sides and into an adjoining space.

A flanking path transmits sound through connections other than the common partition between two spaces. Sound can travel considerable distances in a structure because of flanking noise re-radiating from space to space. Flanking noise is difficult to control because of low frequency of the sound waves and the way in which it is transmitted. Typical flanking paths include open plenums that are over walls and through suspended ceilings, common ductwork, adjacent exterior windows, common floor heaters, open vents and under doors. The sensitivity to details and materials in a structure will determine the effect of flanking noise which is almost impossible to avoid.

### Typical flanking paths through an interior floor and wall assembly

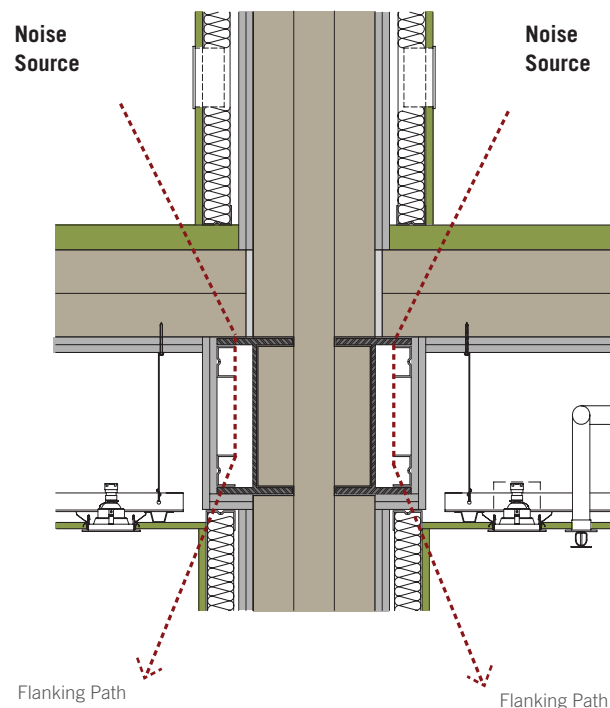

## Mass

The weight or thickness of a partition is one of the major factors in its ability to block sound. Mass is commonly added to existing walls by adding additional layers of gypsum. When the mass of a barrier is doubled, the STC rating increases by approximately 5 dB, which is clearly noticeable. The denser a product the better its sound transmission performance will be. (Canadian Mortgage and Housing Corporation 2009)

## Discontinuity

An air space within a partition or floor assembly can also help to increase sound isolation. When sound vibrations are allowed to move from one wall face to another through a solid internal element, the STC rating significantly decreases. The airspace can be increased or added to a partition by using components such as resilient channels and layers of gypsum board. An airspace of 1 ½" will improve the STC by approximately 3 dB. An air space of 3" will improve the STC by approximately 6 dB. An air space of 6" will improve the STC by approximately 8 dB. (Canadian Mortgage and Housing Corporation 2009)

## Resilient Connections

Fastening horizontal resilient channels to the structural members of an assembly are common approaches used to break the sound transmission path. Resilient channels installed on both sides of a wall may be beneficial where flanking sound can enter the wall framing from above or below. The position and location of resilient channels are important because if installed wrong, can actually decrease the STC rating (e.g. ensuring the resilient channels are oriented with their bottom flange attached to the wall stud framing).

## Absorption

Sound absorptive material can be installed in a cavity wall or floor to reduce sound transmission between spaces. These sound absorbing materials are usually porous foams or fibrous layers so that sound passes easily through them. Examples of sound absorbing materials are mineral wool, glass fiber, cellulose fiber, open cell foams, and acoustical tiles. These materials convert sound vibrations into heat as sound repeatedly reflects from the surfaces of an enclosed space, passing through the sound-absorbing material many times and with each pass, decreasing the sound energy.

## Assembly Components

A sound rating depends on and is affected by the components in any wall or floor assembly. The construction details play a large role in this, from materials and thickness in the layers (gypsum board or sound absorption material) to spacing of studs and resilient channels in a wall assembly. In a floor assembly, the same principals apply where finishing, topping, sub-floor, ceiling boards, sound absorption material, space between layers, and the size and spacing of joists and resilient channels all affect sound ratings. An ideal assembly to control sound transmission would include an airtight construction (especially at penetrations), two layers that are not connected at any point by a solid material, the heaviest or most dense material that would be practical, and the deepest cavity that is practical filled with a sound-absorbing material.

## Addressing sound control issues through assembly components in the tall wood case study

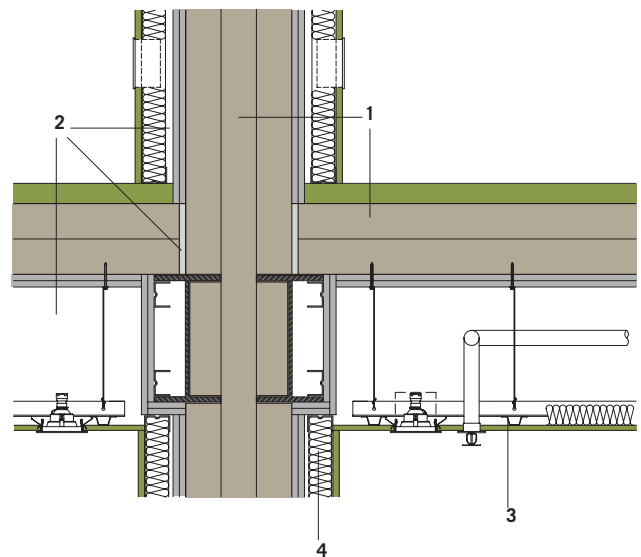

- 1 Mass: density of LVL, LSL, or CLT
- 2 Discontinuity: use of airspace or isolation pad
- 3 Resilient Connections
- 4 Absorption: use of sound absorptive material

## 3.9 Building Enclosure

### The Role of the Building Envelope

The envelope of a building is designed to resist wind and earthquake loads, limit air leakage, control vapour diffusion, prevent rain penetration, prevent surface and cavity condensation, limit excessive heat loss and heat gain, and resist noise and fire.

A common preconception with wood buildings is that they are more prone to weathering and failure and therefore are less likely to last as long as buildings with concrete or steel structures. The reality is that all buildings must consider how to protect the structure from the elements of weather and climate and therefore the performance of a well designed building envelope will extinguish the concerns of one building structure over another. Once protected by an envelope designed to address the environment and particulars of the structure all buildings are effectively equal. It is quite common for example to find wood houses in eastern North America that are 100-200 years old and of wood frame construction. These buildings have endured as the result of suitable envelope design and maintenance over the life of the building.

Each structural material will have a different and unique set of parameters that affect how it is to be protected and how it will perform. By example, lightweight wood frame buildings dry over time and shrink as the moisture content of the wood is removed. This requires consideration in the design of an envelope. Another example is in concrete buildings where any penetration of the concrete from interior to exterior without a suitable insulation and protection layer will cause enormous heat loss through conductivity. This is a common problem seen in the design of concrete buildings around Vancouver. These issues are addressed in all buildings with proper design detailing.

For the vast majority of conditions the approach to designing an envelope for a tall mass timber building will be no different or only very modestly different than designing an envelope for a tall concrete building.

### The History of Vancouver's Leaky Condo Crisis

Part of the legacy image that wood buildings have in Vancouver is particular to the history of envelope failures that caused significant moisture damage in condominiums in Vancouver over the last few decades. The reasons for the envelope failures were numerous but were in part attributable to poor detailing and poor understanding of the movement of wood structures. Light weight wood frame buildings shrink over time as the wood dries to its ultimate stable moisture content. In a typical platform-built wood frame building this means that each floor will see shrinkage over its height. Building envelopes must accommodate that shrinkage to ensure continuity of both the air and vapour barrier layers and the protective exterior building envelope. As a result of an array of issues, including a lack of understanding of the characteristics of good envelope design and wood frame construction, effectively branded wood as a riskier building material than concrete.

This is a critically important preconception to address as wood buildings move into the next generation and specifically as mass timber buildings are introduced into the market.

### The Principles of Envelope Design

Protect the building from degradation due to the impacts of:

1. Water
2. Ice / Snow
3. Solar Radiation
4. Humidity (movement of humidity from inside to outside or vice versa)
5. Temperature variation from inside to outside or vice versa  
- Heat or Cold
6. Movement (due to wind and seismic)
7. Pressure (due to wind – positive and negative forces)
8. Acoustics / Sound
9. Fire / Smoke

To tackle these issues there are several factors to consider:

1. Will the building's movement due to live loads (wind/ seismic/ functional use) put unique stresses on the building's envelope?
2. Will the building's structure change over time? Shrinkage in lightweight wood or creep in concrete for example.
3. How will water be repelled by the exterior protective surface?
4. How will the materials on the exterior dry out if they are wet?
5. How will air flow be controlled?
6. How will vapour flow be controlled?
7. How will the building insulate from heat and/or cold?

### Thermal Performance

Wood, steel and concrete have significant differences in their thermal performance characteristics. These characteristics will affect the performance of the building envelope. The first is thermal conductivity, which is the property of a material's ability to conduct or transmit heat. Essentially, thermal conductivity predicts the rate of energy loss through a piece of material. In building science, this is typically referred to as the U-Value. The greater the U-Value, the greater the amount of energy passes through that material.

Thermal conductivity of some common materials and products are indicated in the table below.

Thermal conductivity (k) is measured in Watts per meter Kelvin (W/(m·K)).

#### Thermal Conductivity - k - W/(m·K)

Material/Substance	Temperature
Aluminum	250
Concrete	1.7
Carbon Steel	54
Glass, window	0.96
Glass, wool Insulation	0.04
Wood across the grain, white pine	0.12
Mass Timber	+/- 0.11

As the above chart illustrates, wood performs considerably better than concrete and steel in terms of thermal conductivity. Thermal conductivity is particularly important in building conditions where thermal bridging can occur, for instance, where floor plates project from the interior to the exterior such as in a balcony. These are areas where large amounts of heat can be lost. Thus, wood, with its low thermal conductivity can significantly out-perform materials such as concrete and steel in areas where thermal bridging is a concern.

The reciprocal of thermal conductivity is thermal resistivity. This is typically known as the R-value which measures the thermal resistance or the ability of a material to resist heat transfer. The greater the R-value the better the insulating properties of that particular material across a thickness.

#### Thermal Resistance – R-value ft.<sup>2</sup>·°F·h/(BTU in)

Material/Substance	R-Value
Concrete	0.08
Glass, window	0.91
Glass, wool Insulation	3.5
Wood (most soft woods)	1.41
Mass Timber	+/- 1.2

#### References:

##### Thermal Conductivity

[http://www.engineeringtoolbox.com/thermal-conductivity-d\\_429.html](http://www.engineeringtoolbox.com/thermal-conductivity-d_429.html)

##### Thermal Resistance

[http://en.wikipedia.org/wiki/R-value\\_\(insulation\)](http://en.wikipedia.org/wiki/R-value_(insulation))

As illustrated, wood drastically out performs concrete in regards to its insulating properties. Concrete which is almost negligible in its contribution to resisting heat transfer is often left exposed without additional insulation. Conversely, mass timber does have contributive thermal properties, notably equaling almost a 1/3 of glass wool insulation. Used as a structural material, mass timber products like CLT can offer tremendous insulating values to an assembly. For instance, a CLT panel of 3 1/2" would have an R-value of 4.2. In the FFTT system, structural panels are deployed in thickness of greater than 7", providing significant baseline insulation for the entire structure.

The result is that wood out performs both steel and concrete in terms of its ability to resist heat transfer and heat loss. Thus, wood has the potential to radically change the way we build from a thermal performance point of view, if employed as a baseline structure.

### **Curtain Wall**

Glass curtain wall systems are very common on tall buildings and are amongst the most weather resistant and airtight exterior wall systems on the market today. These are characterized by large panels of glass, spandrel panels and a grid of window frames. Properly constructed and designed curtain walls will control air leakage, rain penetration and condensation. Additionally, a rainscreen system at the spandrel panels will facilitate water penetration, venting and drying. A comparison of the FFTT system (Options 1 and 2) against its concrete benchmark reveals that there would be no significant difficulties in employing a curtain wall with the FFTT system (refer to section 3.11 Typical Details).

### **Rainscreen**

A rainscreen wall system typically includes an exterior cladding, a cavity behind the cladding drained and vented to the outside; an inner wall plane incorporating an air barrier; and a set of compartment seals limiting the cavity size. The outer layer of the rain screen is typically made up of a cladding that deflects the kinetic force of the rain, while the inner components remain protected. The vented cavity uses gravity and flashings to drain water that penetrates the outer wall. In the FFTT system (Option 3 and 4) where exterior structural walls are utilized, a pressure equalized rain screen system is recommended.

### **Detailing at Grade**

Mass Timber panels should be well protected from moisture at grade. Tall wood buildings will have a concrete foundation and foundation walls to above grade raising the concrete to timber panel connection at least 12" above grade. This height should increase in areas prone to high snow drifting, ponding, flooding or termite concerns. In general there will be a moisture barrier between concrete structures and the mass timber materials in the structure.

Mass timber products..." (especially any exposed portions of the panels and parts in contact with foundations) would benefit from wood preservative such as borate or copper based preservatives, particularly in wetter or more humid climates or where termites are prevalent." "In areas of high termite hazard, such as the Southeastern United States, multiple lines of defense should be used to prevent termite damage to CLT panels"— (FPInnovations 2011)

### **Control of Moisture During Construction**

During construction, it is critical to prevent the wood panels from being exposed to moisture for prolonged periods. Care and consideration can easily alleviate many of the issues that moisture can cause. These include:

- 1.** Pre-fabricate panels to reduce construction time
- 2.** Scheduling of material deliveries to optimize material usage and minimize on-site storage time
- 3.** Use preservative treated lamina for panels that are likely to be exposed to moisture for prolonged periods of time particularly edges and end grains
- 4.** Products such as LVL and LSL from certain manufacturers come with standard water-resistant coating on all faces providing additional weather protection
- 5.** On-site protection such as temporary shelters
- 6.** Consider season for construction

## Diagrams



## Envelope Comparison

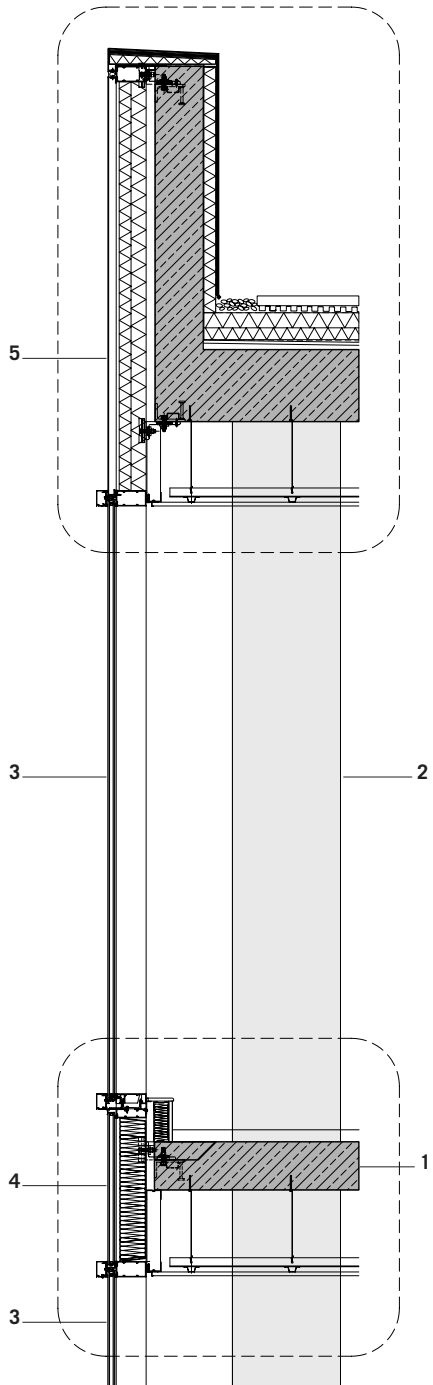

- 1 Concrete floor slab (2HR FRR)
- 2 Concrete column beyond (2HR FRR)
- 3 Vision glass
- 4 Spandrel glass panel
- 5 Spandrel glass panel or non-combustible cladding

**Typical concrete tower curtain wall facade section**

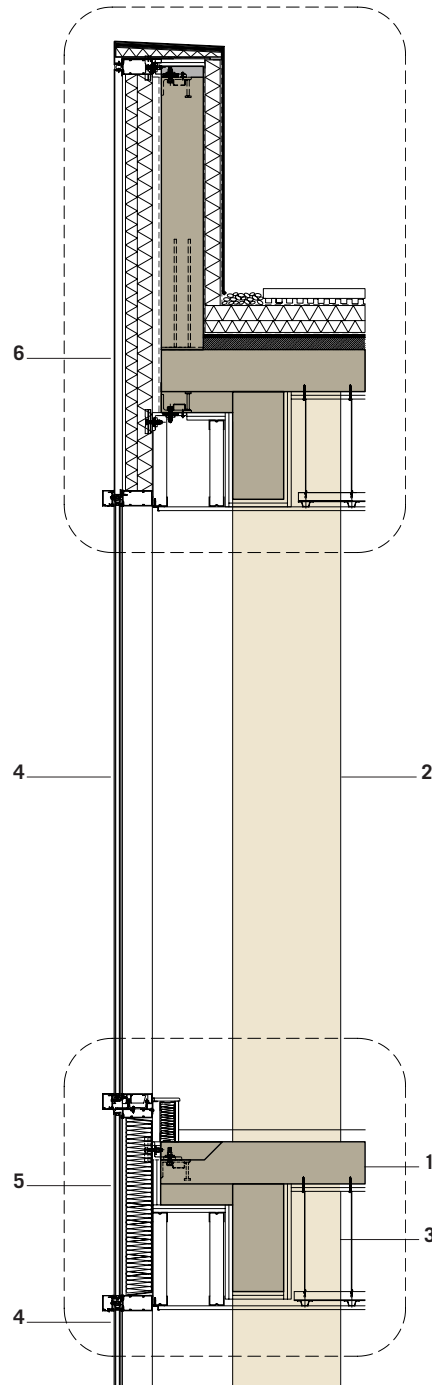

- 1 2 layer mass timber + 2 layer 5/8" type X gypsum board (2HR FRR)
- 2 Glulam column + 2 layer 5/8" type X gypsum board beyond (2HR FRR)
- 3 Glulam beam + 2 layer 5/8" type X gypsum board (2HR FRR)
- 4 Vision glass
- 5 Spandrel glass panel
- 6 Spandrel glass panel or non-combustible cladding

**Tall wood case study curtain wall facade section (option 1 + 2)**

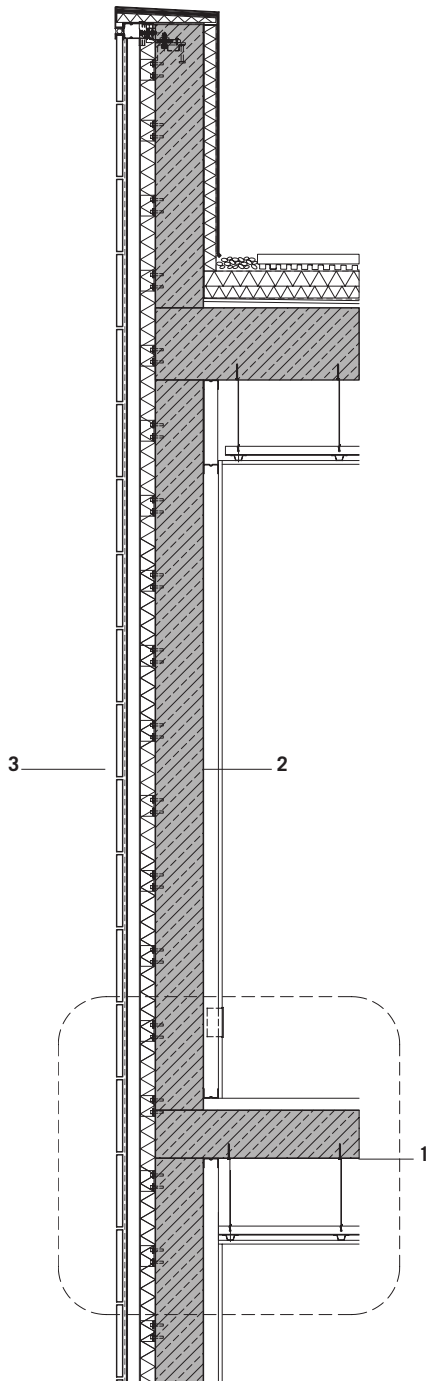

- 1 Concrete floor slab (2HR FRR)
- 2 Concrete wall (2HR FRR)
- 3 Non-combustible cladding + rainscreen

**Typical concrete tower facade section**

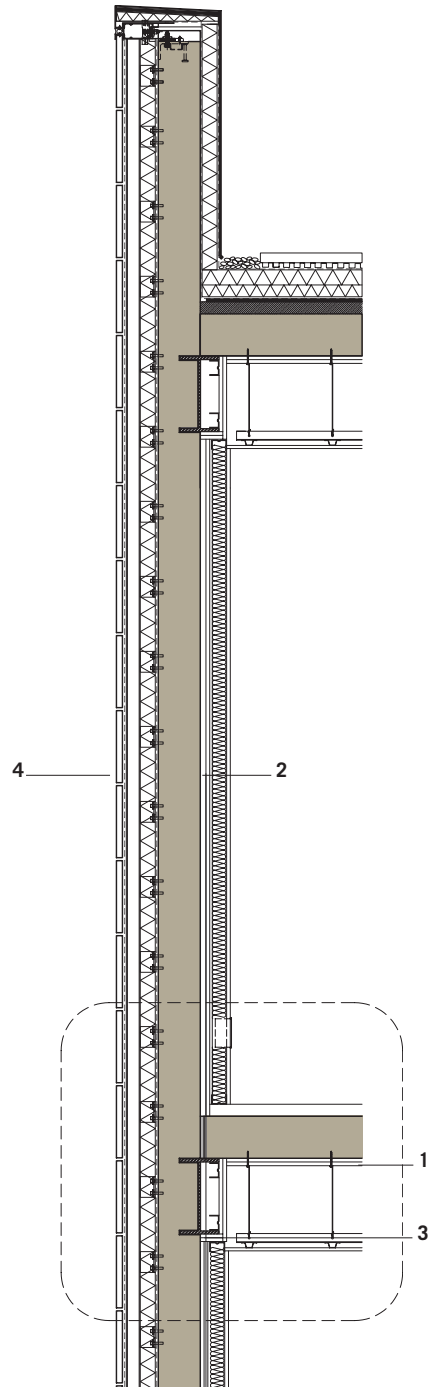

- 1 Mass timber structure + 2 layer 5/8" type X gypsum board (2HR FRR)
- 2 2 layer LVL, LSL or CLT + 2 layer 5/8" type X gypsum board (2HR FRR)
- 3 Steel beam
- 4 Non-combustible cladding + rainscreen

**Tall wood case study facade section (option 3 + 4)**

### Material Moisture Content / Shrinkage

One of the significant differences between lightweight wood-frame buildings and mass timber buildings is the difference in shrinkage over time as the wood's moisture content stabilizes to the building's environment. While it is typical to see significant shrinkage in lightweight framing where initial wood stud moisture content typically ranges from 15% up to 19% and eventually stabilizes at 8 to 10%, the moisture content in mass timber and engineered wood general starts with a moisture content of 8-10% during fabrication. This results in stable materials during fabrication and extremely little shrinkage along the main axis of the material during the life of a building. Slightly more shrinkage

will be found across the thickness of CLT material than LSL/LVL due to CLT's solid wood composition. As a result a platform based CLT construction system as was built for the Stadhaus project in London can result in accumulative shrinkage over the height of the building that may require consideration in the detailing of the exterior envelope. The FTTT system which balloon frames using the length of the mass timber panels will see extremely little shrinkage and therefore will not require special consideration for shrinkage in the envelope. Shrinkage in FTTT would be similar to that of a concrete building as concrete creep occurs during the initial curing stage of the material.

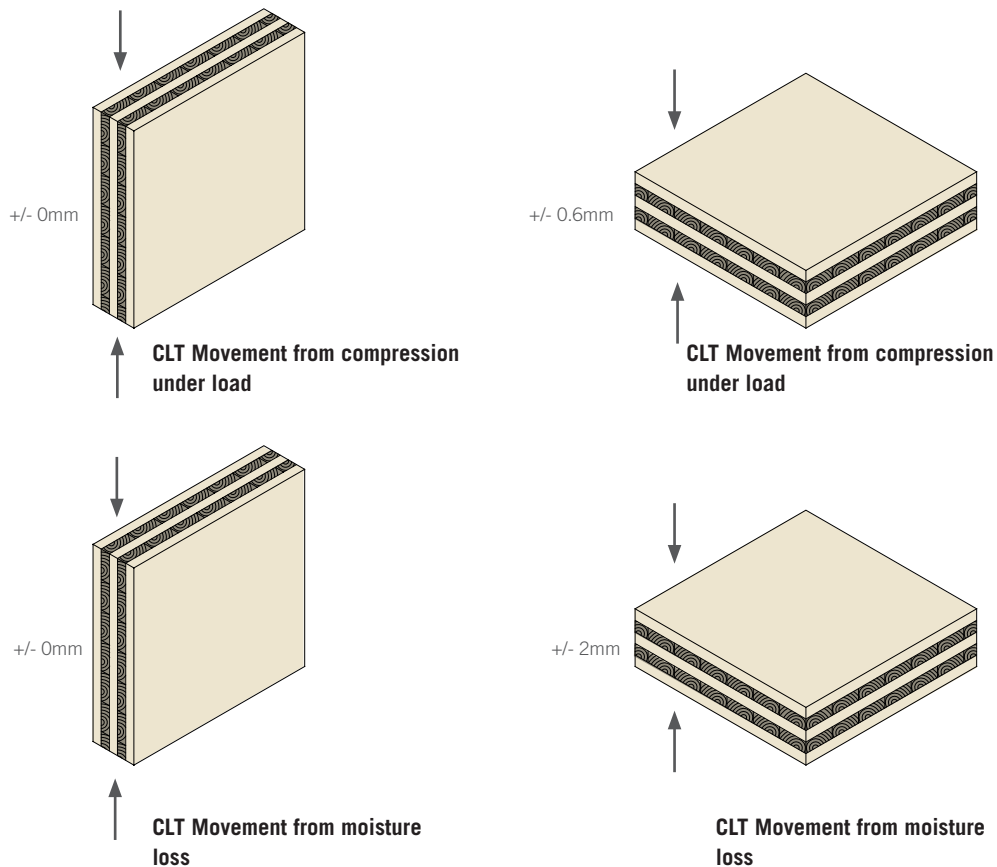

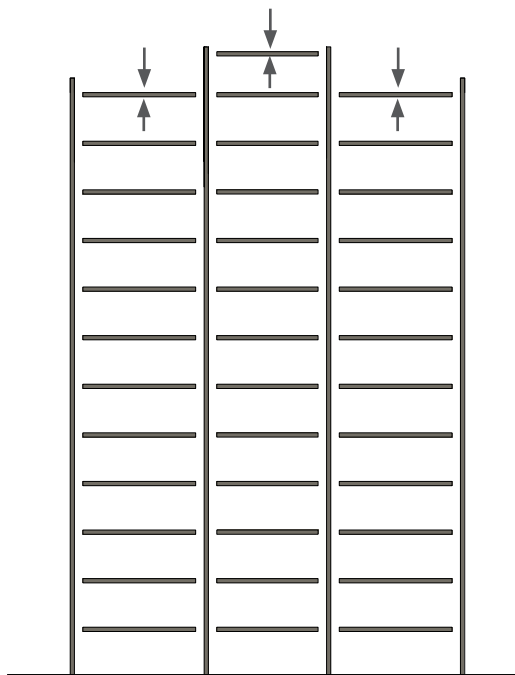

**FFTT Framing diagram**  
 Cumulative Shrinkage = 0

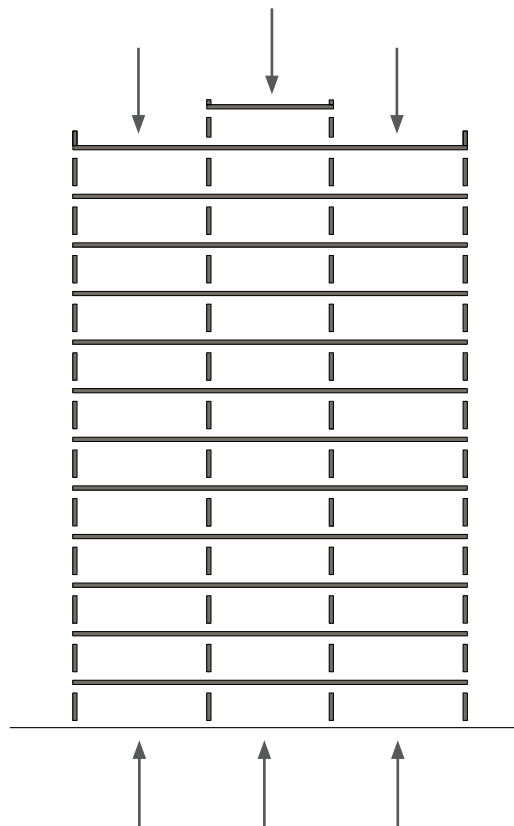

**Platform Framing diagram**  
 Cumulative Shrinkage = 31.2 mm

### 3.10 Systems Integration

At a building scale, systems have been integrated as they would be in a typical concrete tall building; continuously through vertical rated shafts and locally through fire rated vertical and horizontal penetrations.

Within the units or suites, systems integration can be handled one of three ways, dependant on the method of fire separation and the desired interior finish:

**1. CNC or route out chases within the mass timber panels to receive all services.** This method is popular in Europe, but requires a high level of pre-construction coordination (and offers no flexibility during construction) that is not typical of North American construction practice.

**2. Encapsulation approach to fire separation** - provide chases or cavities (non-combustible) both horizontal and vertical to run services outside of the fire protection layer. This is the most flexible approach and is most akin to current North American construction practice.

**3. Charring approach to fire separation** - provide a zone of services along the suite's floor perimeter and at doorways to run services and outlets. This requires some pre-construction coordination but retains flexibility during the construction phase. This option retains a sprinklered cavity at the ceiling level which could be localized if services are ganged together.

The diagrams that follow illustrate both options 2 and 3.

<p>1 Mass timber structure + sacrificial layer          2 Mass timber structure + sacrificial layer          3 Finish floor. Radiant in light weight gypsum topping or concrete topping. If using baseboard heating refer to floor assemblies page for flooring options          4 Finish ceiling: 1 layer 5/8" type X gypsum board          5 Facade (non-combustible). Refer to envelope section for additional information          6 Pot light          7 Sprinkler (concealed space sprinkler)          8 Base with chase for electrical outlet          9 Light switch or similar control          10 Ceiling mounted exit sign</p>	<p>11 Chase beyond for wiring. 2 Layer 5/8" type X gypsum board (2HR FRR)          12 Exhaust penetration with fire stopping (refer to penetration details)          13 **Ceiling and floor: sacrificial mass timber protection layer. On walls, used as a finished layer. CLT Charring rate - 0.65 mm/min. (2HR FRR = 78mm) [3"]          ** Charring rates vary depending on timber type, moisture, density and species. The charring rate of 0.65mm/min is the generally accepted average. Refer to Section 3.7 Fire Performance for additional information on charring rate.</p>
---	--

**Opposite: Tall wood case study typical section illustrating systems integration. Charring only concept shown.**

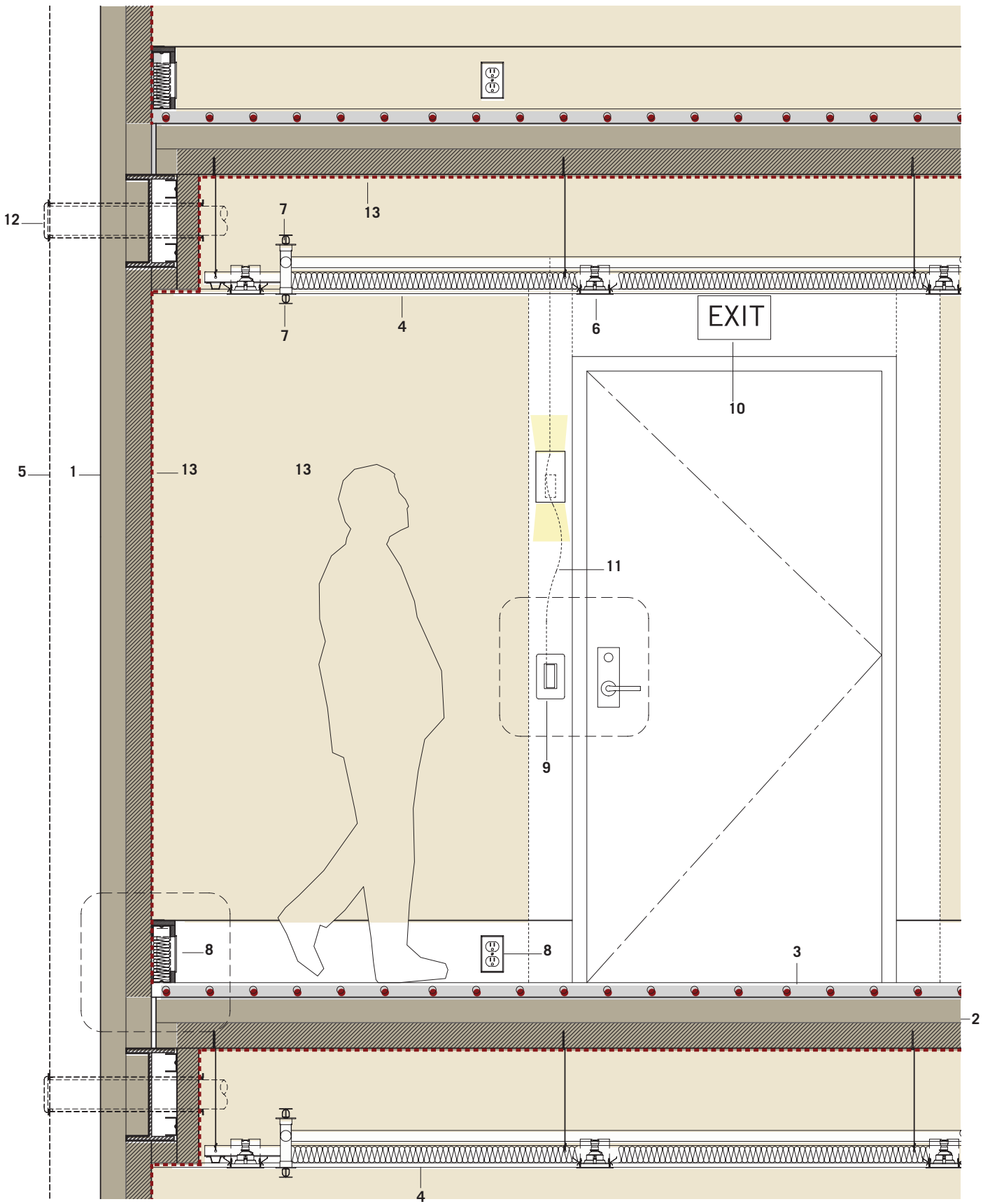

**Systems integration typical details**

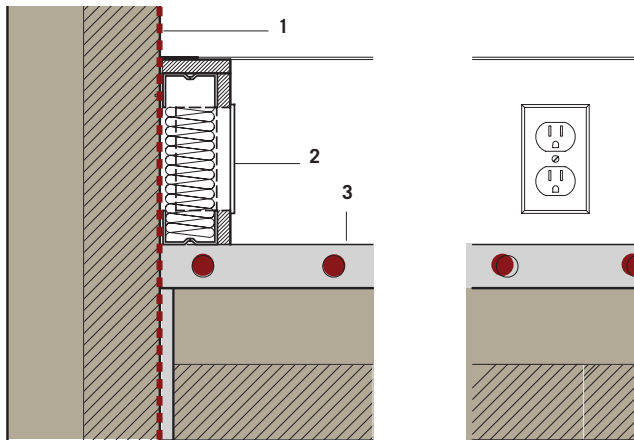

- 1 \*\*Mass timber structural panels + sacrificial mass timber layer (2HR FRR)
- 2 Furring, baseboard, chase for wiring and electrical socket
- 3 Finish floor. Radiant in light weight gypsum topping or concrete topping

**Tall wood case study typical section illustrating systems integration. Charring only concept shown. Baseboard and chase for electrical sockets, data communications**

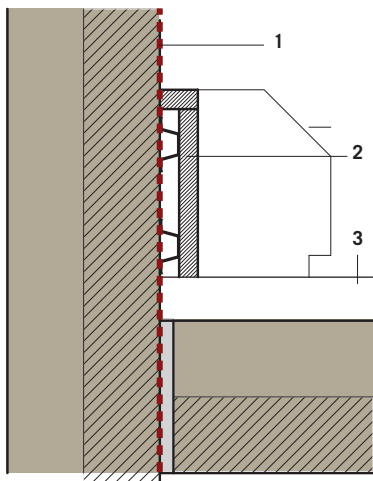

- 1 \*\*Mass timber structural panels + sacrificial mass timber layer (2HR FRR)
- 2 Furring, baseboard, chase for wiring and baseboard heater
- 3 Finish floor. Refer to floor assemblies for various options

\*\* Charring rates vary depending on timber type, moisture, density and species. The charring rate of 0.65mm/min is the generally accepted average. Refer to Section 3.7 Fire Performance for additional information on charring rate.

**Tall wood case study typical section illustrating systems integration. Charring only concept shown. Baseboard heater option.**

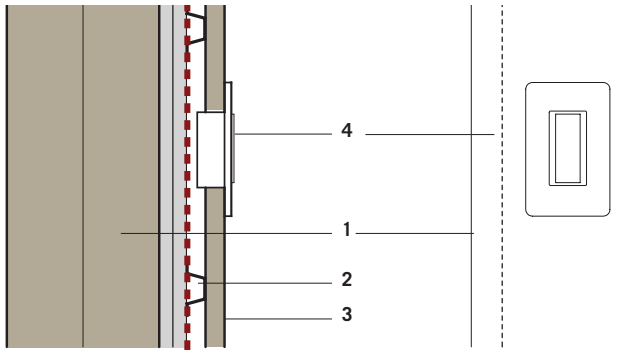

- 1 Mass timber structural panels + 2 layer type X gypsum board (2HR FRR)
- 2 Furring and chase for wiring
- 3 Finish wall
- 4 Light switch or similar device

**Tall wood case study typical section illustrating systems integration. Encapsulation only concept. Electrical chase for switches, light sconces, fire pulls, alarms, intercoms and thermostats.**



**Systems integration typical details**

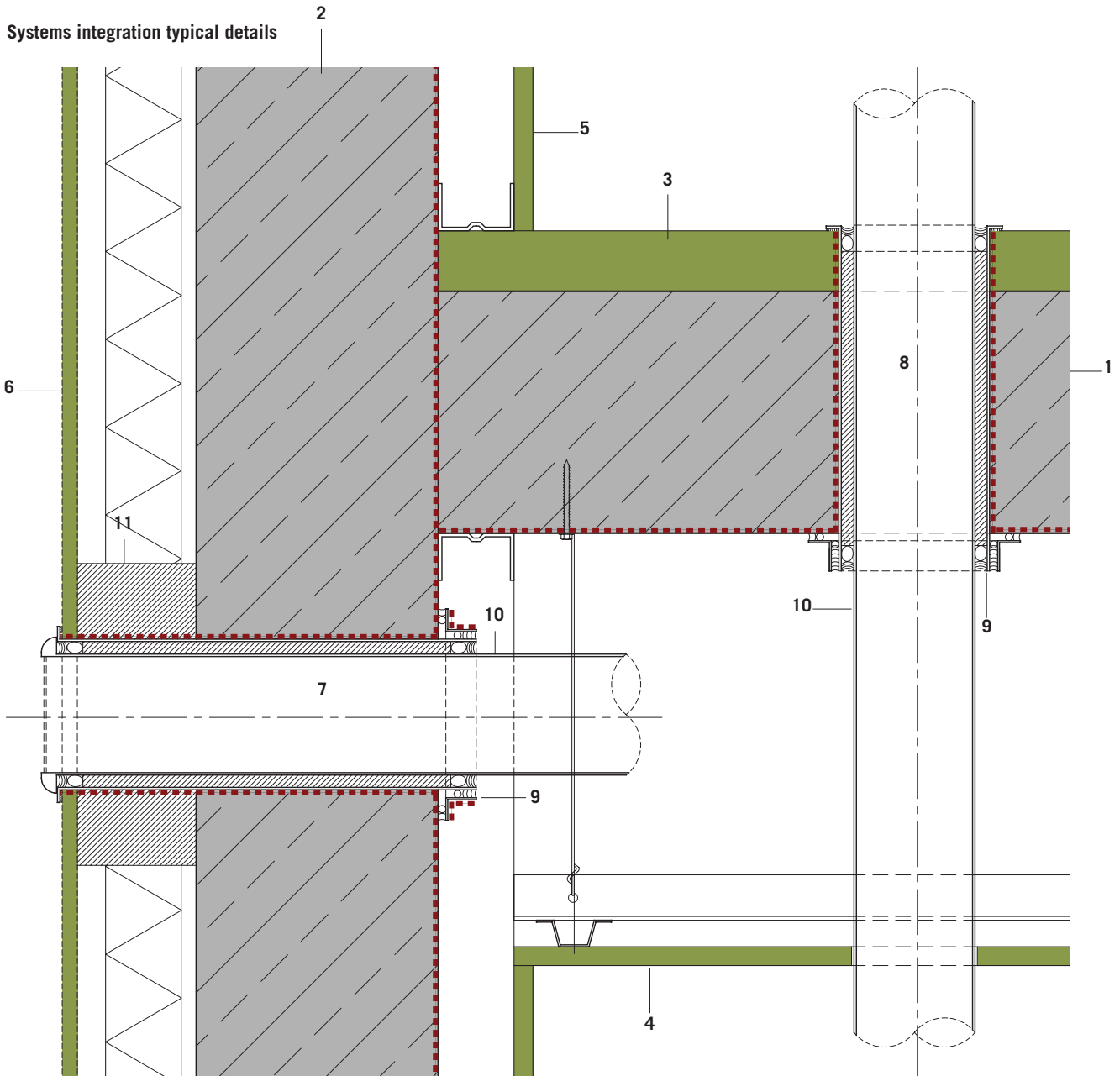

- |   |   |    |  |
|---|---|----|--|
| 1 | Cast in place concrete floor (2HR FRR)    | 7  | Horizontal exhaust penetration with fire stopping                                |
| 2 | Cast in place concrete wall (2HR FRR)     | 8  | Vertical exhaust penetration with fire stopping                                  |
| 3 | Finish floor                              | 9  | Prefinished metal flange with perimeter fire rated sealant                       |
| 4 | Finish ceiling: 1 layer 5/8" gypsum board | 10 | Sleeve C/W flange and filled with spray insulation. Fire stop at sleeve location |
| 5 | Finish wall: 1 layer 5/8" gypsum board    | 11 | Spray insulation   |
| 6 | Facade (non-combustible)                  |    |  |

**Typical concrete tower penetrations at floor and wall**

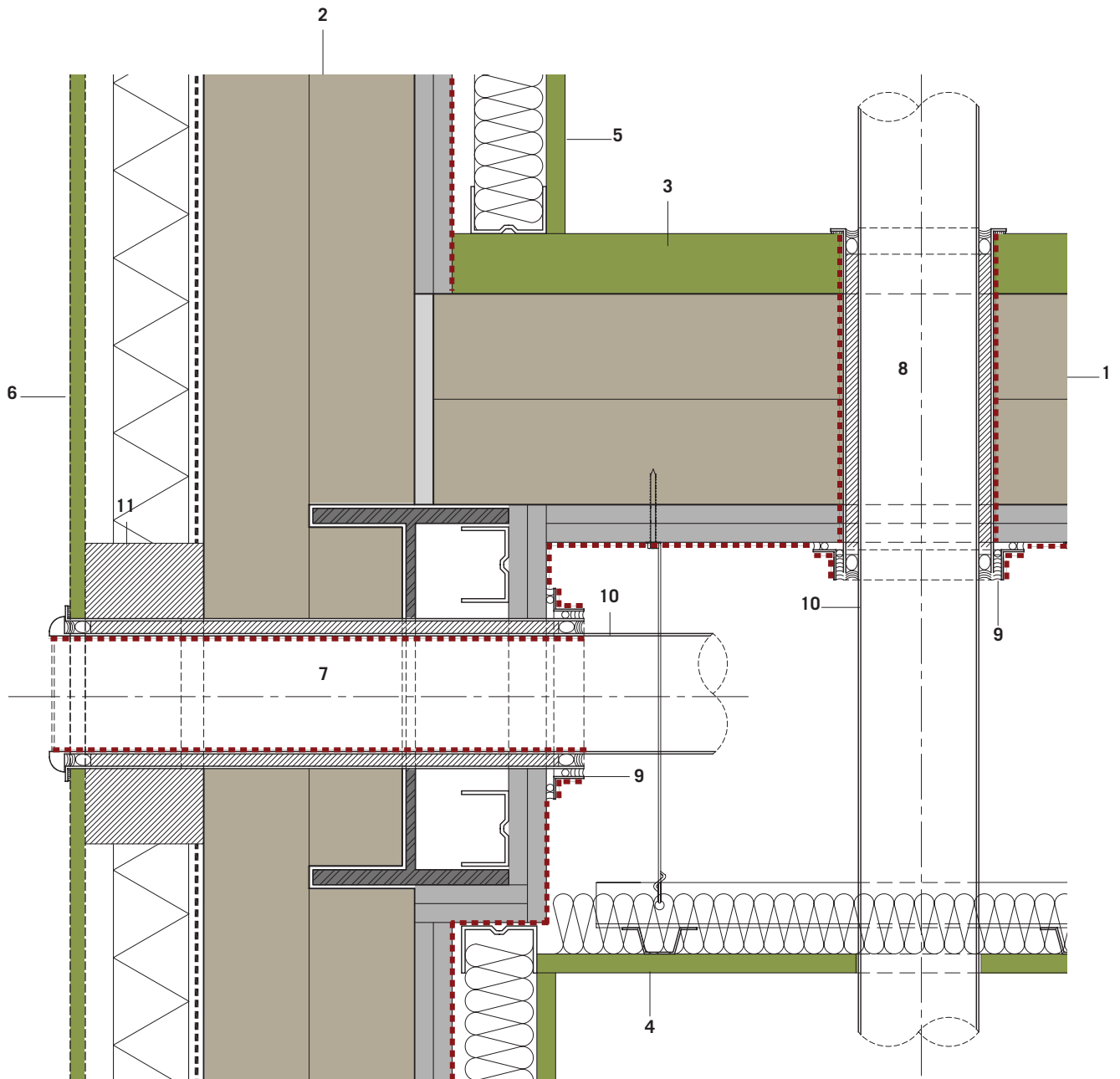

- |   |  |    |  |
|---|--|----|--|
| 1 | Mass timber structural panels + 2 Layer 5/8" type X gypsum board (2HR FRR) | 7  | Horizontal exhaust penetration with fire stopping          |
| 2 | Mass timber structural panels + 2 Layer 5/8" type X gypsum board (2HR FRR) | 8  | Vertical exhaust penetration with fire stopping            |
| 3 | Finish floor   | 9  | Prefinished metal flange with perimeter fire rated sealant |
| 4 | Finish ceiling: 1 layer 5/8" gypsum board                                  | 10 | Sleeve C/W flange and filled with spray insulation.        |
| 5 | Finish wall: 1 layer 5/8" gypsum board                                     | 11 | Fire stop at sleeve location                               |
| 6 | Facade (non-combustible)   |    | Spray insulation   |

**Typical wood case study tower floor and wall section at exterior wall**

### 3.11 Typical Details

#### FFTT Typical Details

The following illustrations are a set of generic details developed for the FFTT system. These details investigate pertinent issues such as fire ratings, acoustics, finishing, envelope considerations and systems integration. The departure point for these details are based on a set of typical conditions that would be encountered in the concrete benchmark. Thus, each FFTT detail is compared through these illustrations, to a concrete detail of the same condition. In doing so, the pros and cons of each system can be easily identified and compared. Moreover, as an important component of the FFTT system, details for two fire-protection strategies are included. The first is the encapsulation method, where the required fire-ratings are achieved by encapsulating the assemblies with gypsum board. The second, the charring method, utilizes a sacrificial layer of wood to achieve the required fire ratings. Refer to Section 3.7 on Fire Performance for additional information on encapsulation and charring.

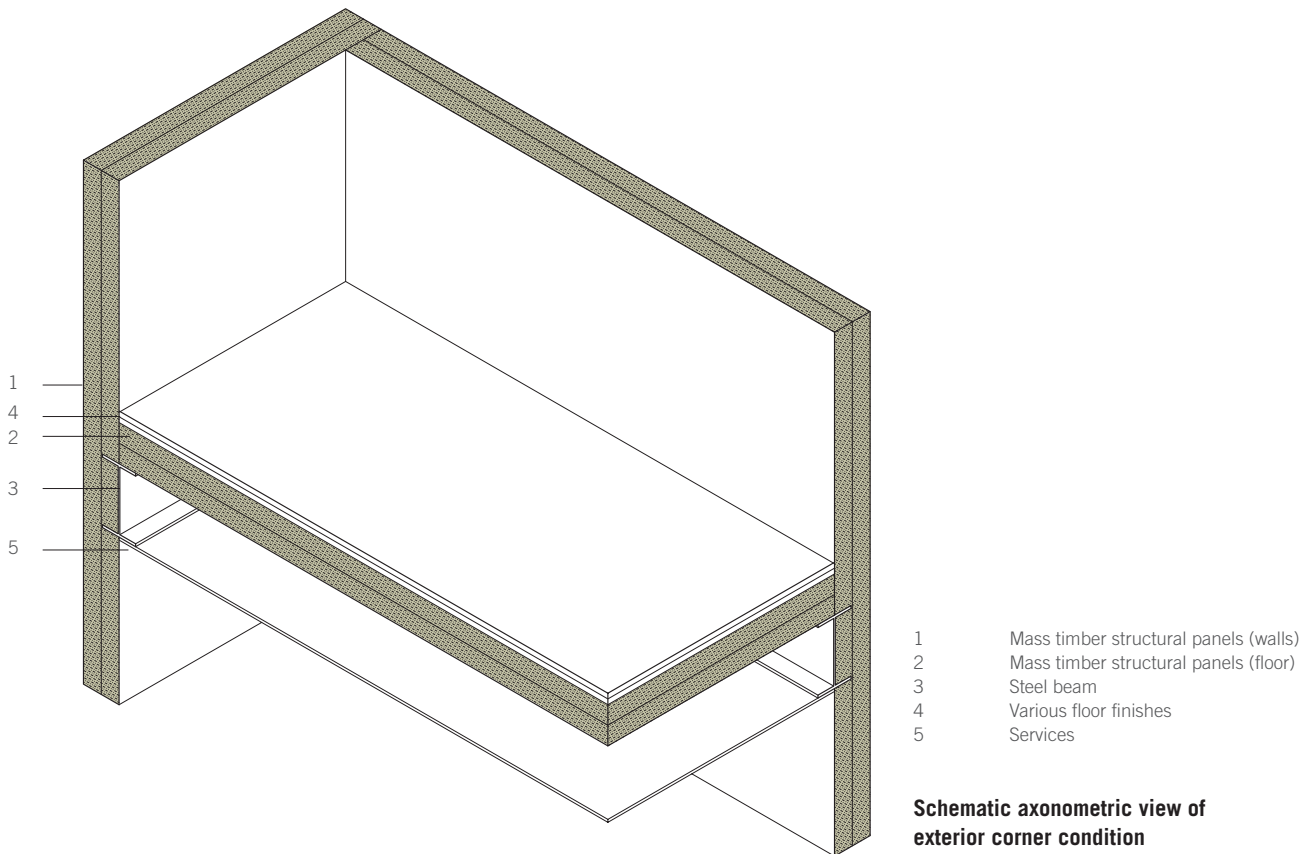

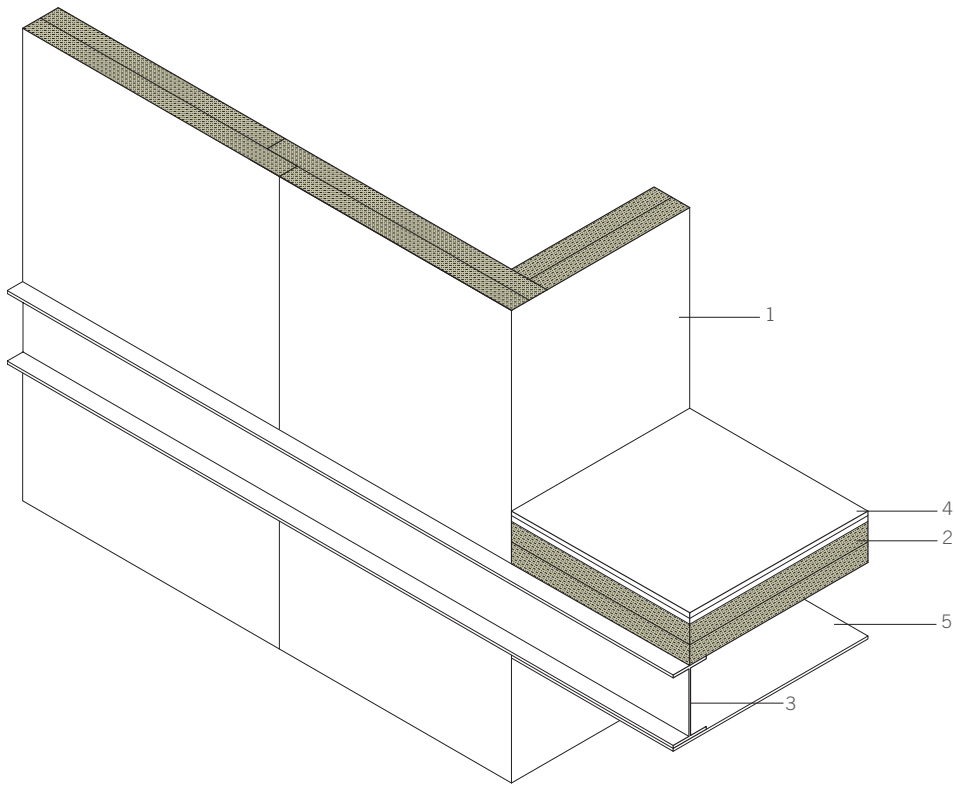

- 1 Mass timber structural panels (walls)
- 2 Mass timber structural panels (floor)
- 3 Steel beam
- 4 Various floor finishes
- 5 Services

**Axonometric view of steel beam at core wall**

## **FFTT Floor Assemblies**

The following table provides various possibilities for flooring assemblies using the FFTT system. Within the FFTT system, the structure is principally independent of the floor system, unlike its concrete counterpart where floors are cast to be integral with the walls and columns. This affords great flexibility in terms of options for floor assemblies. The assemblies illustrated here are only intended as a guideline and should be further designed in regards to structural, acoustic and fire performance considerations.

## Floor Assemblies Options

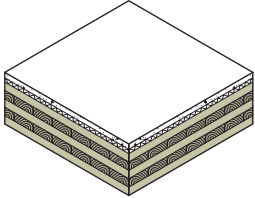
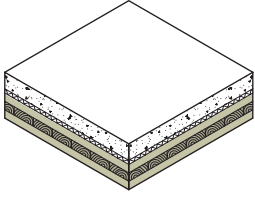
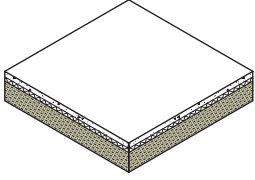
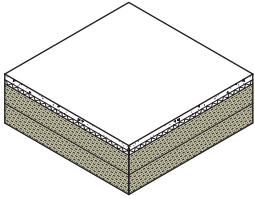
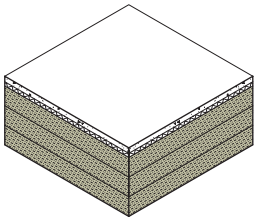
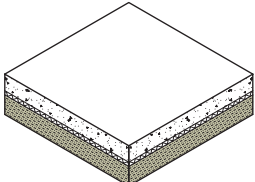
		Assembly	Span	Depth	Weight	STC Rating
0	Concrete	130mm concrete	N/A	130mm	kg/SM	52
1	CLT	55mm concrete topping 25mm rigid insulation 190mm CLT (5 layers)	8000mm	270mm		
						
2	CLT - concrete composite	75mm concrete topping 19mm rigid insulation 114mm CLT (3 layers)	12000mm	208mm		
						
3a	LSL - single layer	38mm concrete topping 19mm rigid insulation 89mm LSL panel	2400mm	146mm		
						
3b	LSL - double layer	38mm concrete topping 19mm rigid insulation 178mm LSL panel	6000mm	235mm		
						
3c	LSL - triple layer	38mm concrete topping 19mm rigid insulation 267mm LSL panel	6000mm + 324mm			
						
4	LSL - concrete composite	75mm concrete topping 19mm rigid insulation 89mm LSL panel	6000mm	183mm		
						

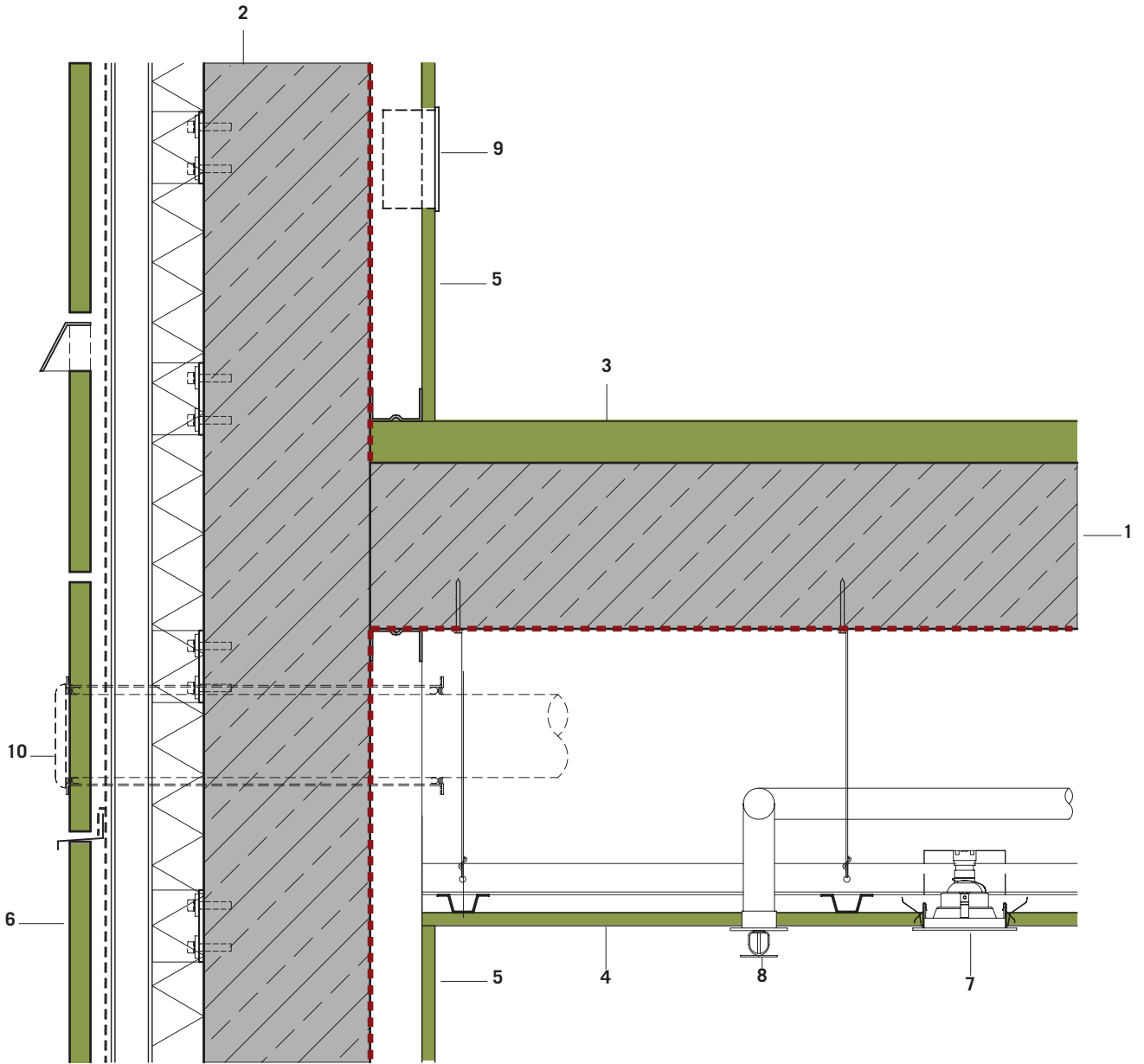

- 1 Cast in place concrete floor (2HR FRR)
- 2 Cast in place concrete wall (2HR FRR)
- 3 Finish floor
- 4 Finish ceiling: 1 layer 5/8" gypsum board
- 5 Finish wall: 1 layer 5/8" gypsum board
- 6 Rain screen facade (non-combustible). Refer to typical envelope details.
- 7 Pot light
- 8 Sprinkler (concealed space sprinkler)
- 9 Electrical outlet
- 10 Exhaust penetration with fire stopping

**Typical concrete tower floor and wall section at exterior wall**

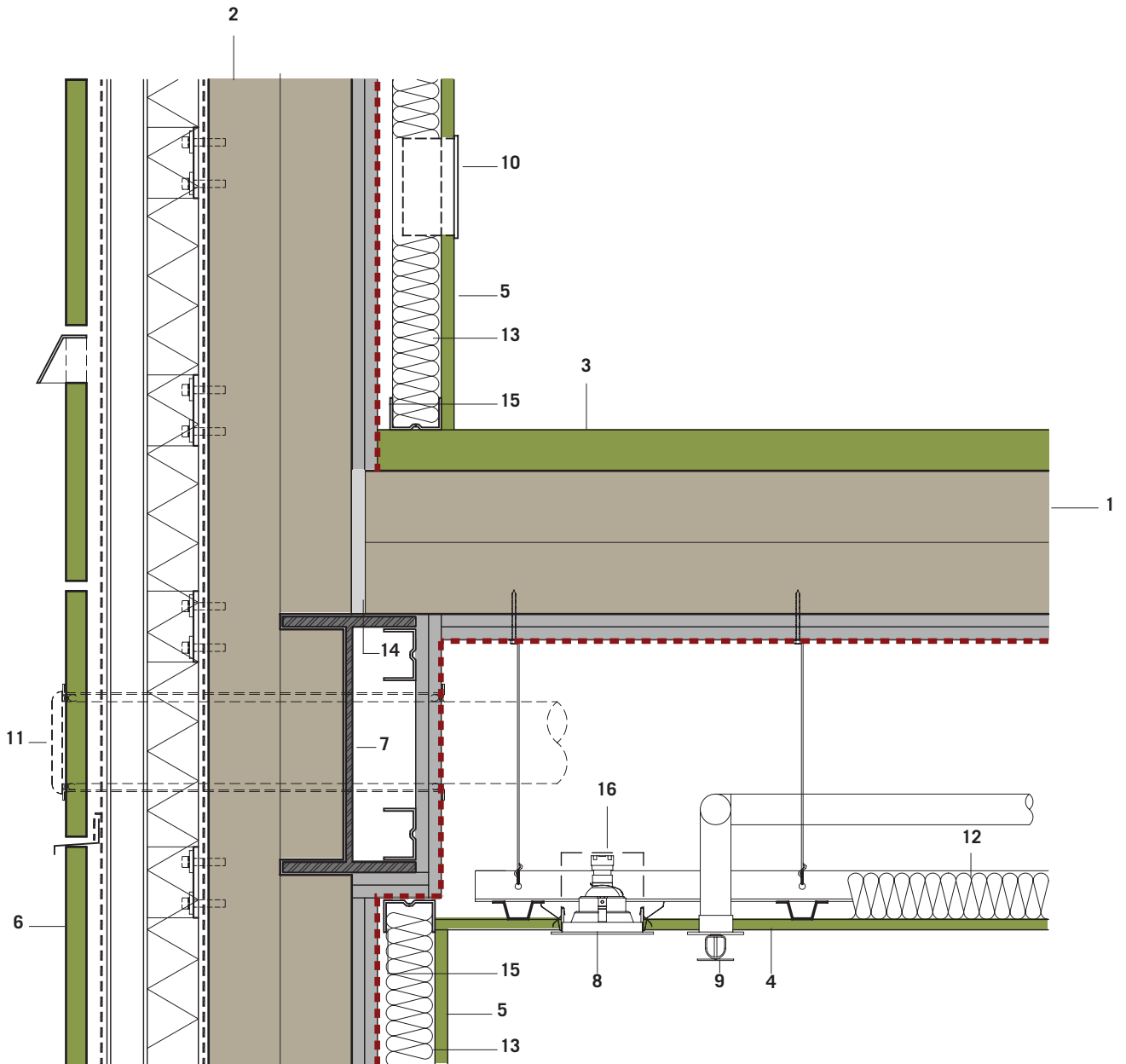

- |   |  |    |   |
|---|--|----|---|
| 1 | Mass timber structural panels + 2 Layer 5/8" gypsum board underside only (2HR FFR)     | 8  | Pot light   |
| 2 | Mass timber structural panels + 2 Layer 5/8" gypsum board interior side only (2HR FFR) | 9  | Sprinkler (plastic pipe)  |
| 3 | Finish floor (refer to floor assembly table)   | 10 | Electrical outlet   |
| 4 | Finish ceiling: 1 layer 5/8" gypsum board  | 11 | Exhaust penetration with fire stopping                          |
| 5 | Finish wall: 1 layer 5/8" gypsum board   | 12 | 2" loose mineral wool insulation for sound absorption (ceiling) |
| 6 | Rain screen facade (non-combustible). Refer to typical envelope details                | 13 | 2" loose mineral wool insulation for sound absorption (wall)    |
| 7 | Steel beam   | 14 | Gasket to reduce sound transmission between floor and wall      |
|   |  | 15 | Gap between drywall and stud to reduce sound transmission       |
|   |  | 16 | Back boxes for light fixtures to reduce sound transmission      |

### Tall wood case study floor and wall section at exterior wall



Typical Details

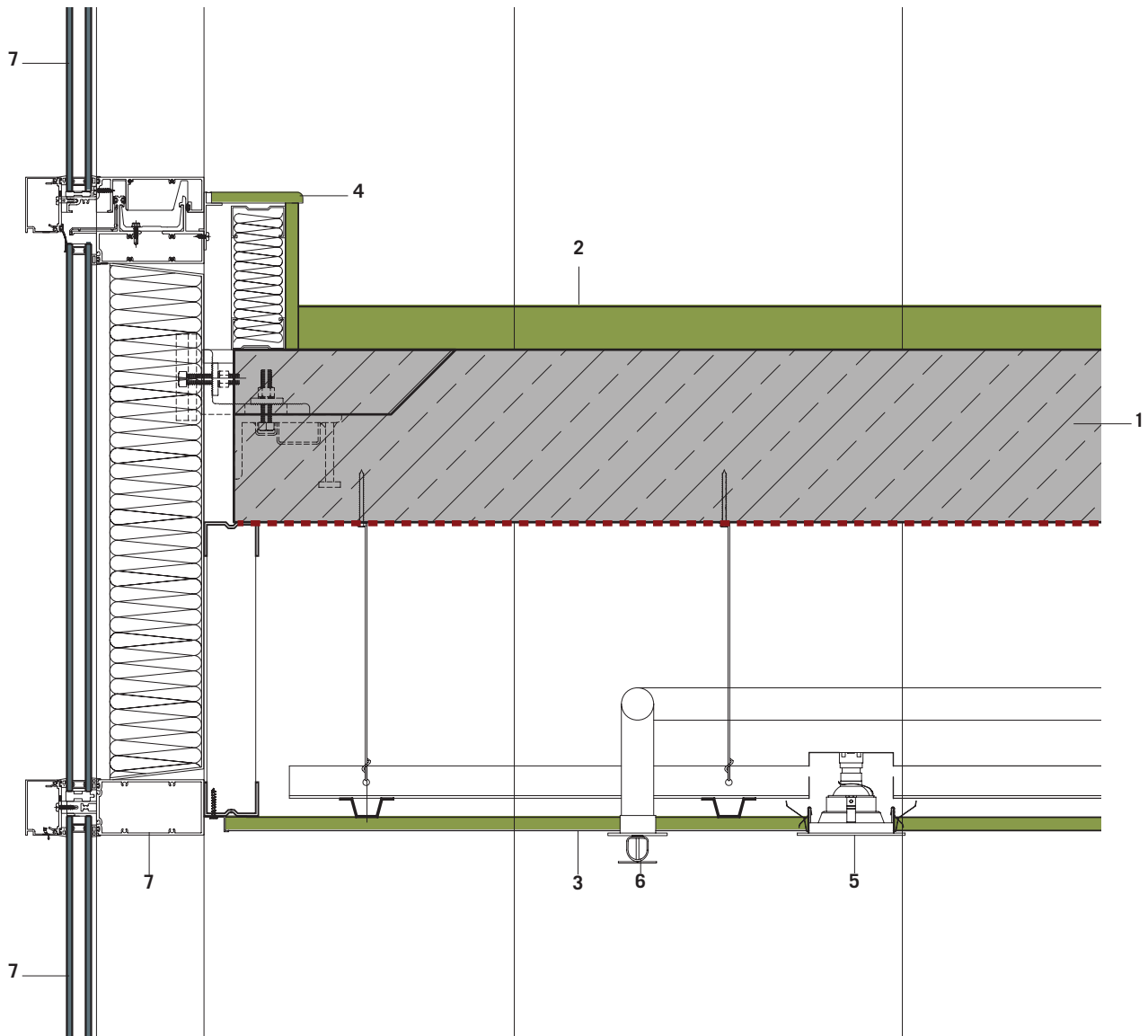

- 1 Cast in place concrete floor (2HR FRR)
- 2 Finish floor
- 3 Finish ceiling: 1 layer 5/8" gypsum board
- 4 Base
- 5 Pot light
- 6 Sprinkler (concealed space sprinkler)
- 7 Curtain wall facade system. Refer to typical envelope details.

Typical concrete tower floor and wall section at curtain wall

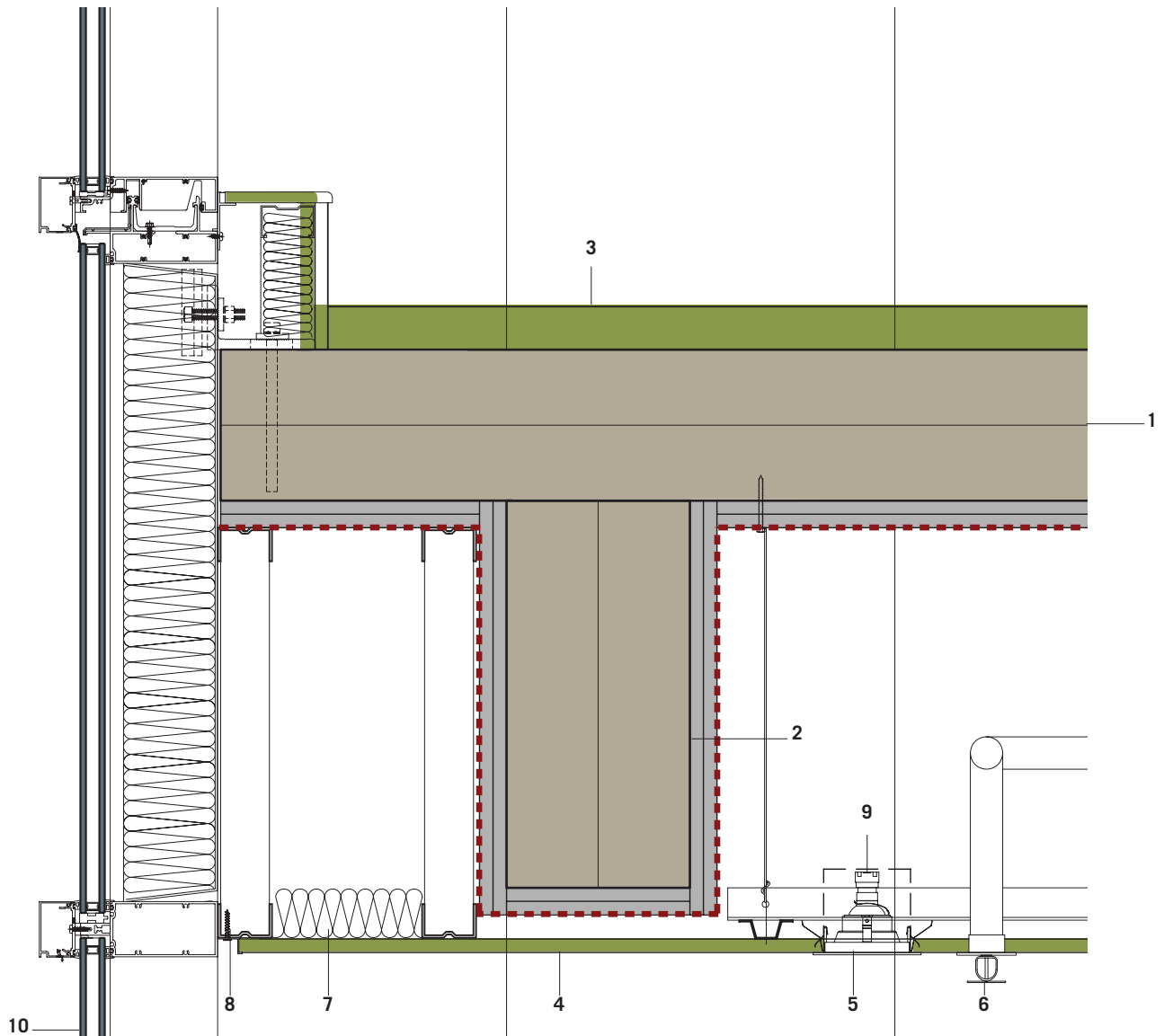

- 1 Mass timber structural panels + 2 Layer 5/8" gypsum board underside only (2HR FFR)
- 2 Glulam beam + 2 Layer 5/8" gypsum board (2HR FFR)
- 3 Finish floor (refer to floor assembly details)
- 4 Finish ceiling: 1 layer 5/8" gypsum board
- 5 Pot light
- 6 Sprinkler (concealed space sprinkler)
- 7 2" loose mineral wool insulation for sound absorption (ceiling)
- 8 Acoustic seal
- 9 Back boxes for light fixtures to reduce sound transmission
- 10 Curtain wall facade system. Refer to typical envelope details.

**Tall wood case study floor and wall section at exterior wall**

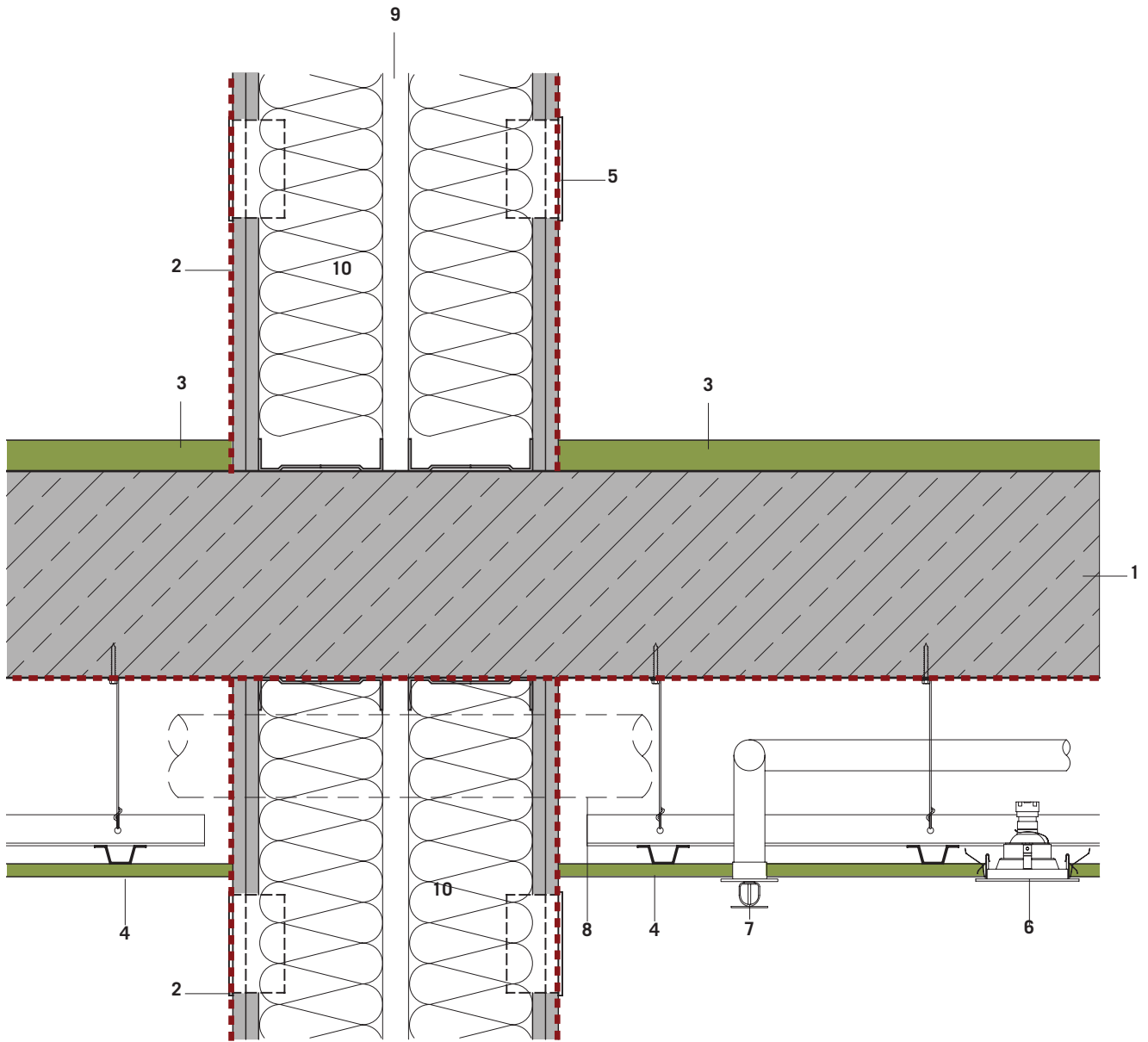

- 1 Cast in place concrete floor (2HR FRR)
- 2 Double steel stud wall with 2 layer type x 5/8" gypsum board on both sides
- 3 Finish floor
- 4 Finish ceiling; 1 layer 5/8" gypsum board
- 5 Electrical outlet
- 6 Pot light
- 7 Sprinkler
- 8 Duct with fire stopping
- 9 Air space between walls to reduce sound transmission
- 10 Mineral wool insulation for sound absorption

**Typical concrete tower typical non-load bearing interior partition between units**

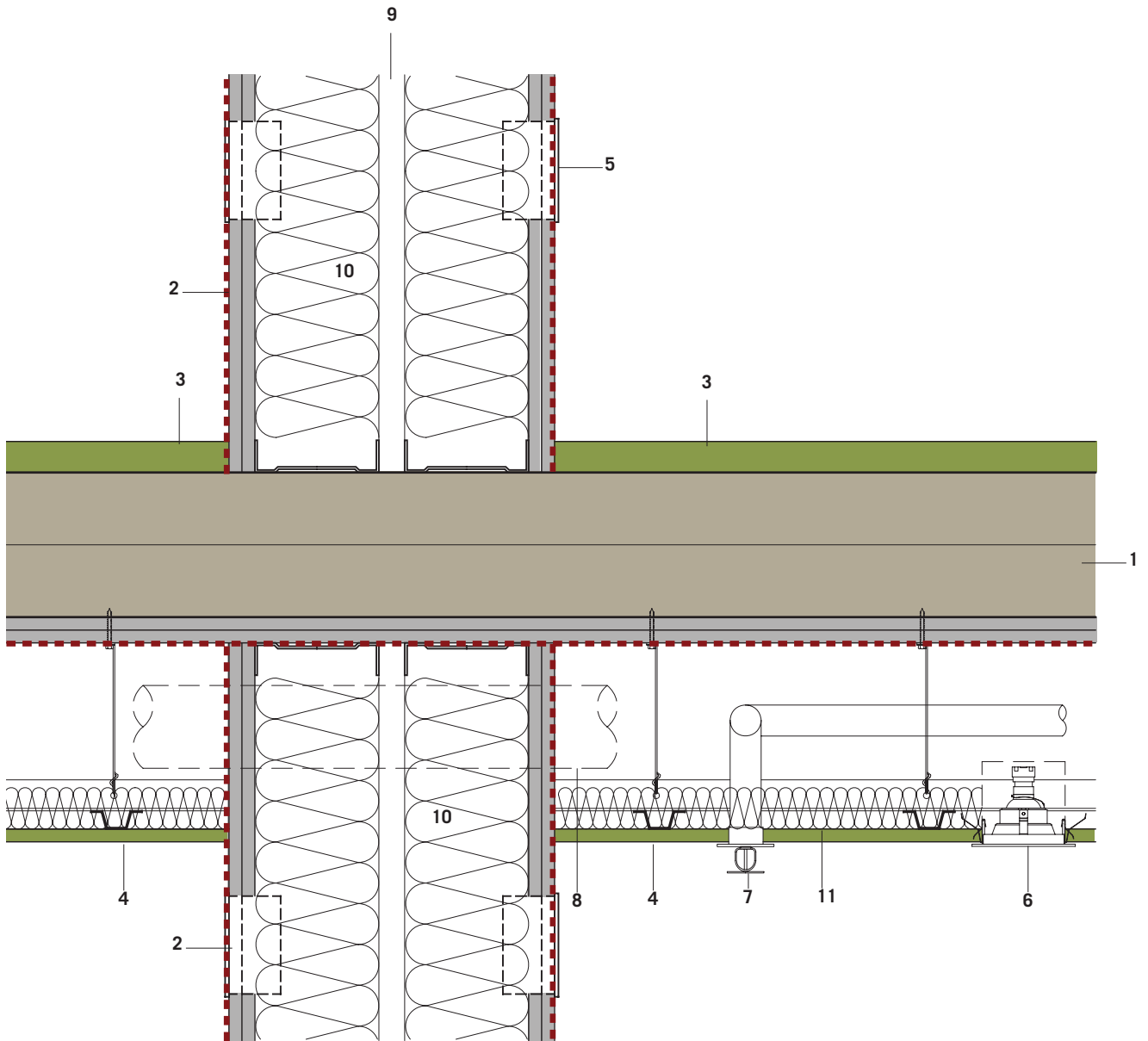

- 1 Mass timber structural panels + 2 Layer 5/8" type X gypsum board on underside only (2HR FRR)
- 2 Double steel stud wall with 2 layer type x 5/8" gypsum board on outer sides only
- 3 Finish floor (refer to floor assembly details)
- 4 Finish ceiling: 1 layer 5/8" gypsum board
- 5 Electrical outlet
- 6 Pot light
- 7 Sprinkler
- 8 Duct with fire stopping
- 9 Air space between walls to reduce sound transmission
- 10 Mineral wool insulation for sound absorption
- 11 2" loose mineral wool insulation for sound absorption

**Tall wood case study typical non-load bearing interior partition between units**

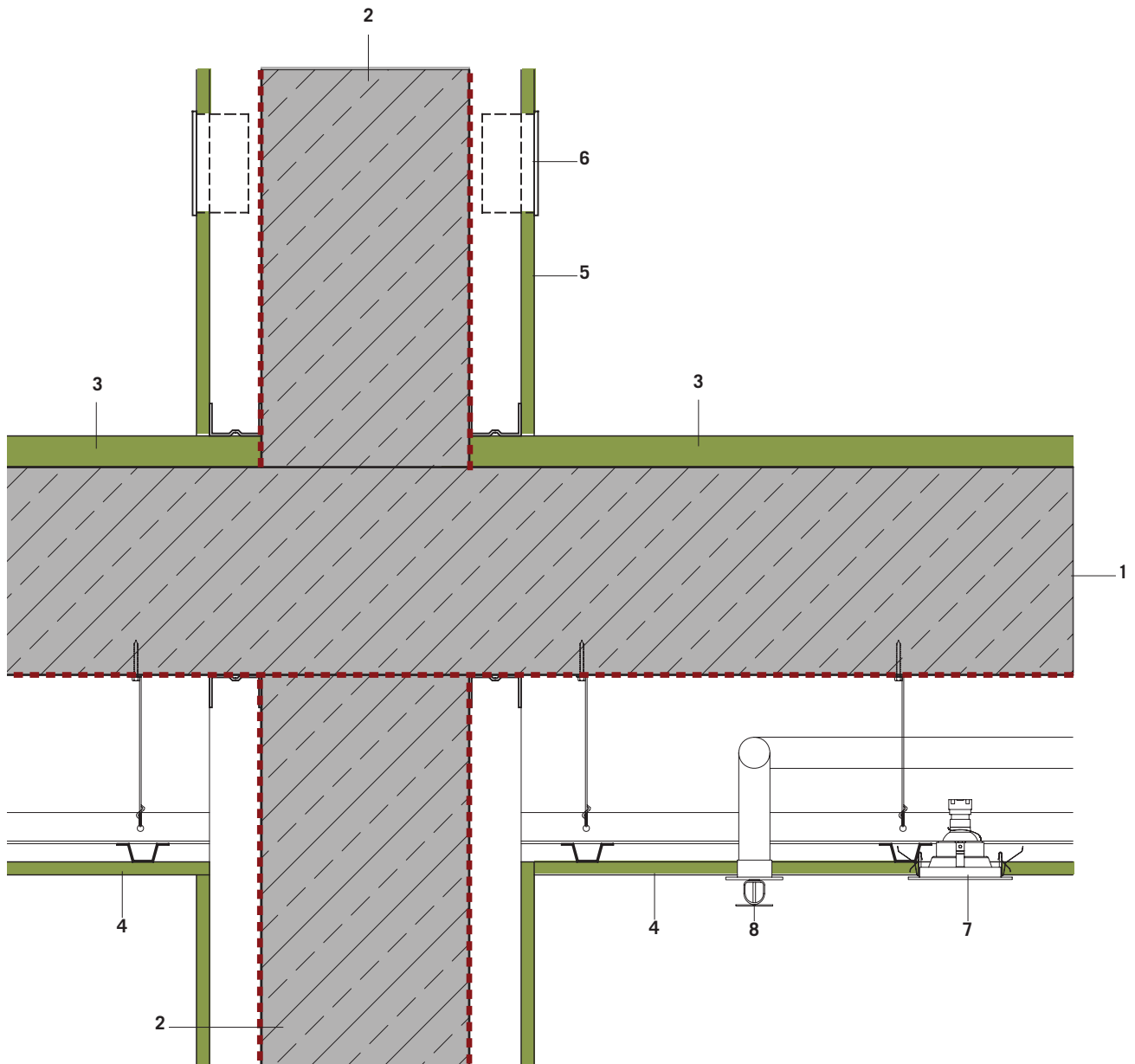

- 1 Cast in place concrete floor (2HR FRR)
- 2 Cast in place concrete wall (2HR FRR)
- 3 Finish floor
- 4 Finish ceiling: 1 layer 5/8" gypsum board
- 5 Furring and finish wall: 1 layer 5/8" gypsum board
- 6 Electrical outlet
- 7 Pot light
- 8 Sprinkler

**Typical concrete tower typical load bearing interior partition**

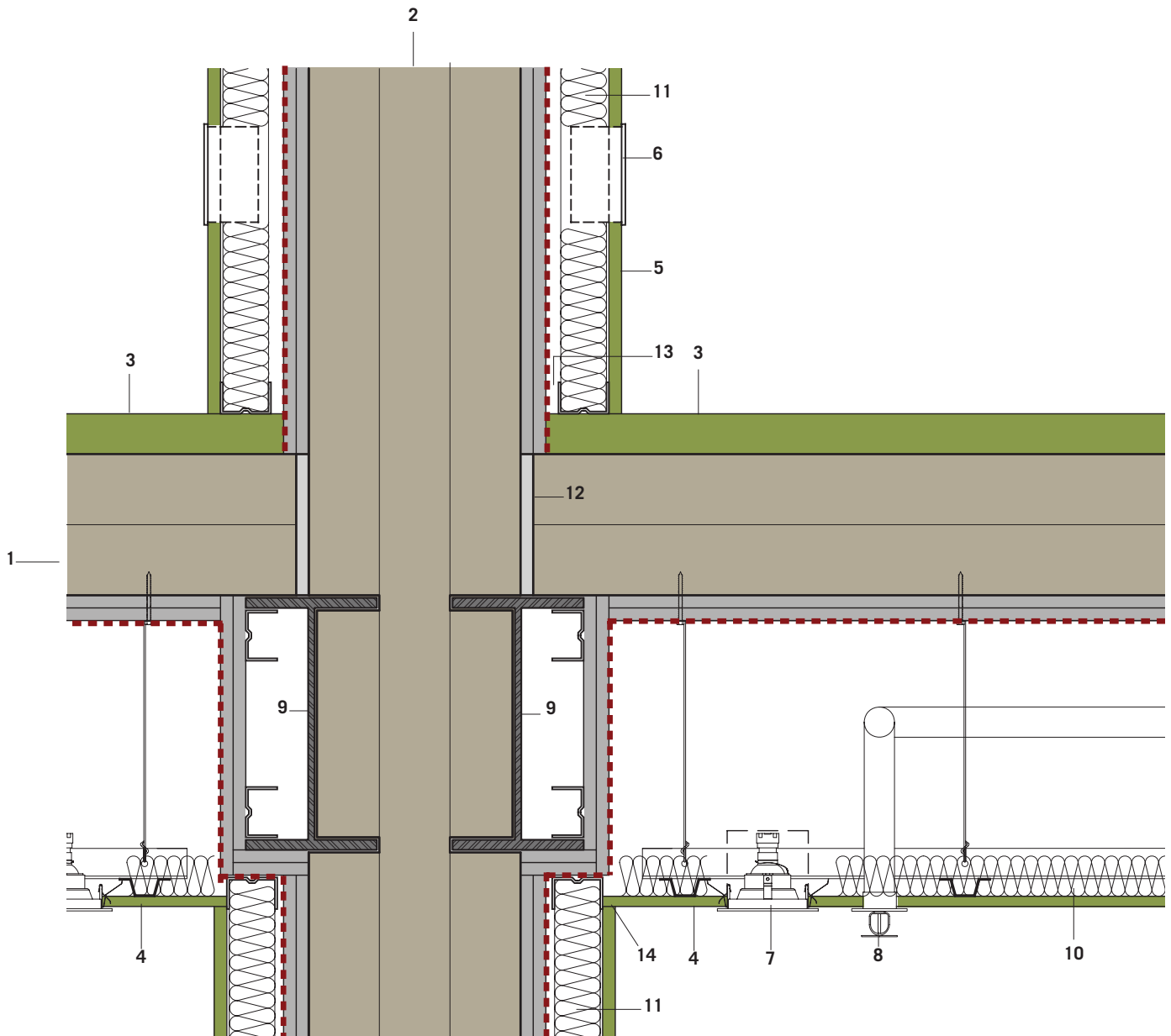

- |   |   |
|---|---|
| <p>1 Mass timber structural panels + 2 Layer 5/8" type X gypsum board (2HR FRR)</p> <p>2 Mass timber structural panels + 2 Layer 5/8" type X gypsum board (2HR FRR)</p> <p>3 Finish floor: (refer to floor assembly table)</p> <p>4 Finish ceiling: 1 layer 5/8" gypsum board</p> <p>5 Furring and finish wall: 1 layer 5/8" gypsum board</p> <p>6 Electrical outlet</p> <p>7 Pot light</p> <p>8 Sprinkler (plastic pipe)</p> <p>9 Steel beam</p> | <p>10 2" loose mineral wool insulation for sound absorption (ceiling)</p> <p>11 2" loose mineral wool insulation for sound absorption (wall)</p> <p>12 Gasket to reduce sound transmission between floor and wall</p> <p>13 Gap between drywall and stud to reduce sound transmission</p> <p>14 Acoustic seal</p> |
|---|---|

**Tall wood case study typical load bearing interior partition**

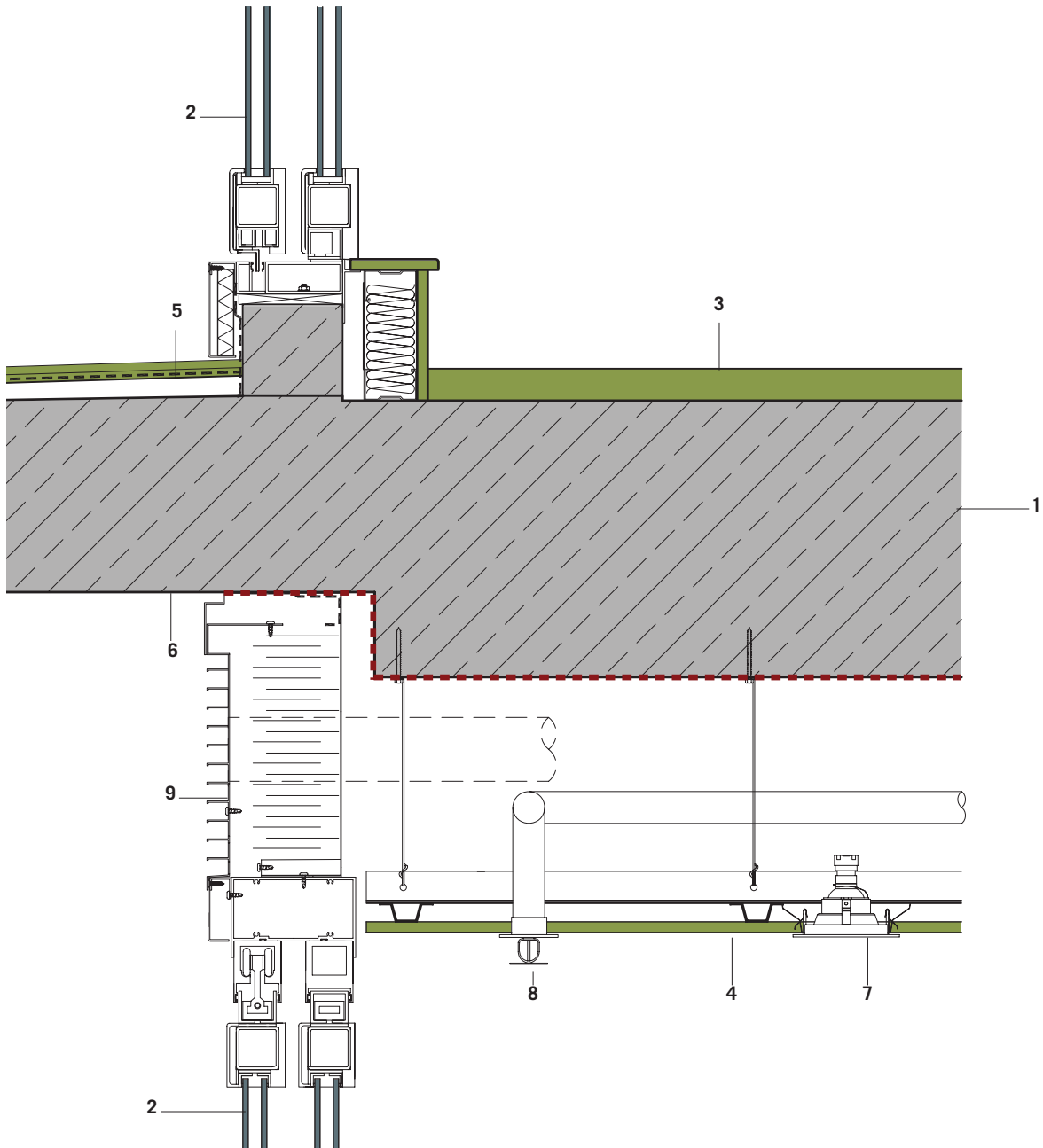

- 1 Cast in place concrete floor (2HR FRR)
- 2 Balcony door
- 3 Finish floor
- 4 Finish ceiling: 1 layer 5/8" gypsum board
- 5 Finish floor balcony (sloping with waterproofing)
- 6 Exposed concrete
- 7 Pot light
- 8 Sprinkler
- 9 Spandrel panel + exhaust

**Typical concrete tower sliding door section at balcony**

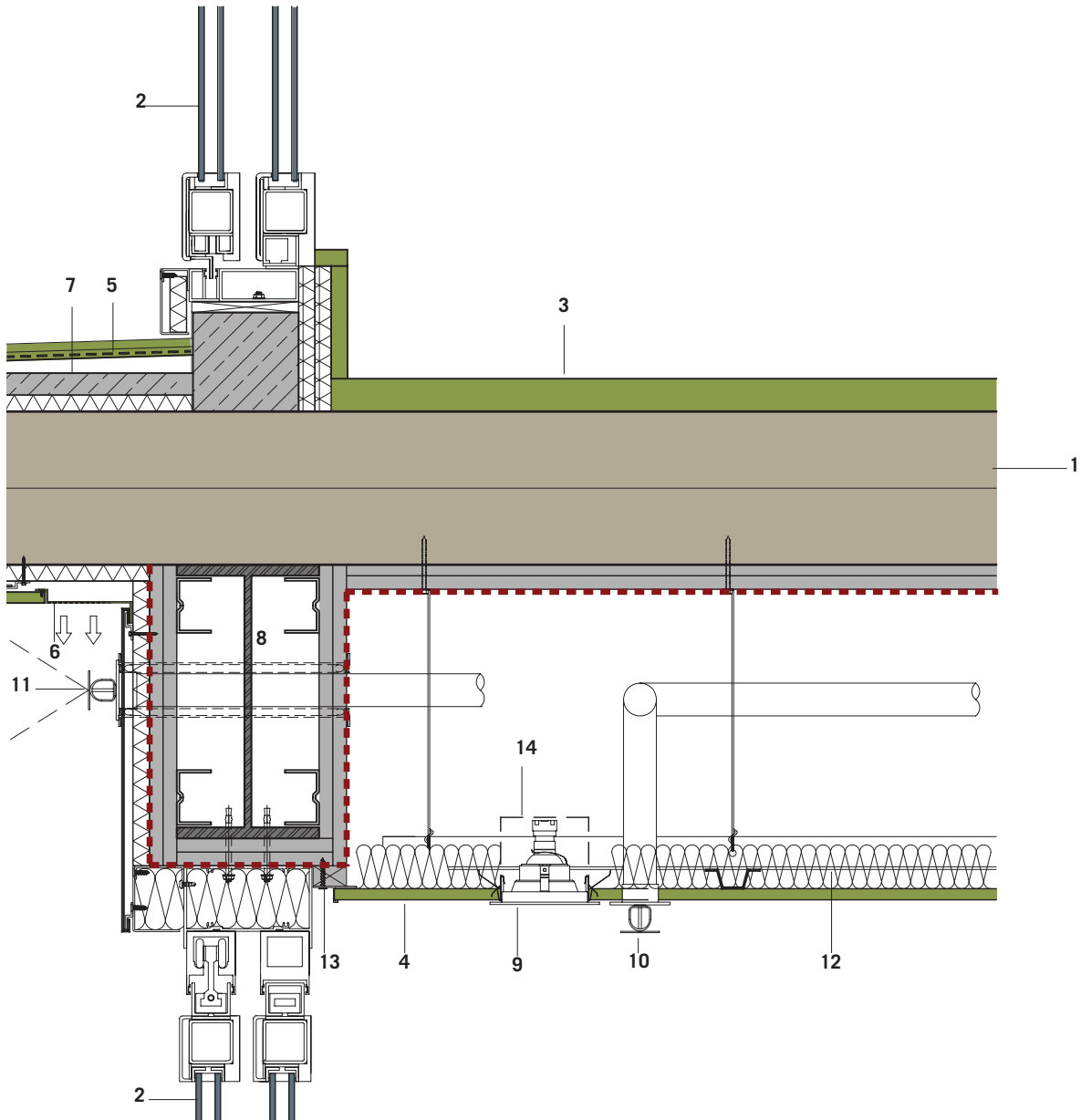

- |   |   |    |  |
|---|---|----|--|
| 1 | Mass timber structural panels + 2 Layer 5/8" type X gypsum board underside only (2HR FRR) | 8  | Steel beam   |
| 2 | Balcony door  | 9  | Pot light  |
| 3 | Finish floor (refer to floor assembly details)  | 10 | Sprinkler  |
| 4 | Finish ceiling: 1 layer 5/8" gypsum board   | 11 | Dryhead sprinkler with fire stopping (up to 10' outboard)  |
| 5 | Finish ceiling balcony (sloping waterproofing)  | 12 | 2" loose mineral wool insulation for sound absorption      |
| 6 | Exterior soffit with prefinished perforated vent.   | 13 | Acoustic seal  |
| 7 | Concrete topping and curb (2HR FRR)   | 14 | Back boxes for light fixtures to reduce sound transmission |

### Tall wood case study sliding door section at balcony



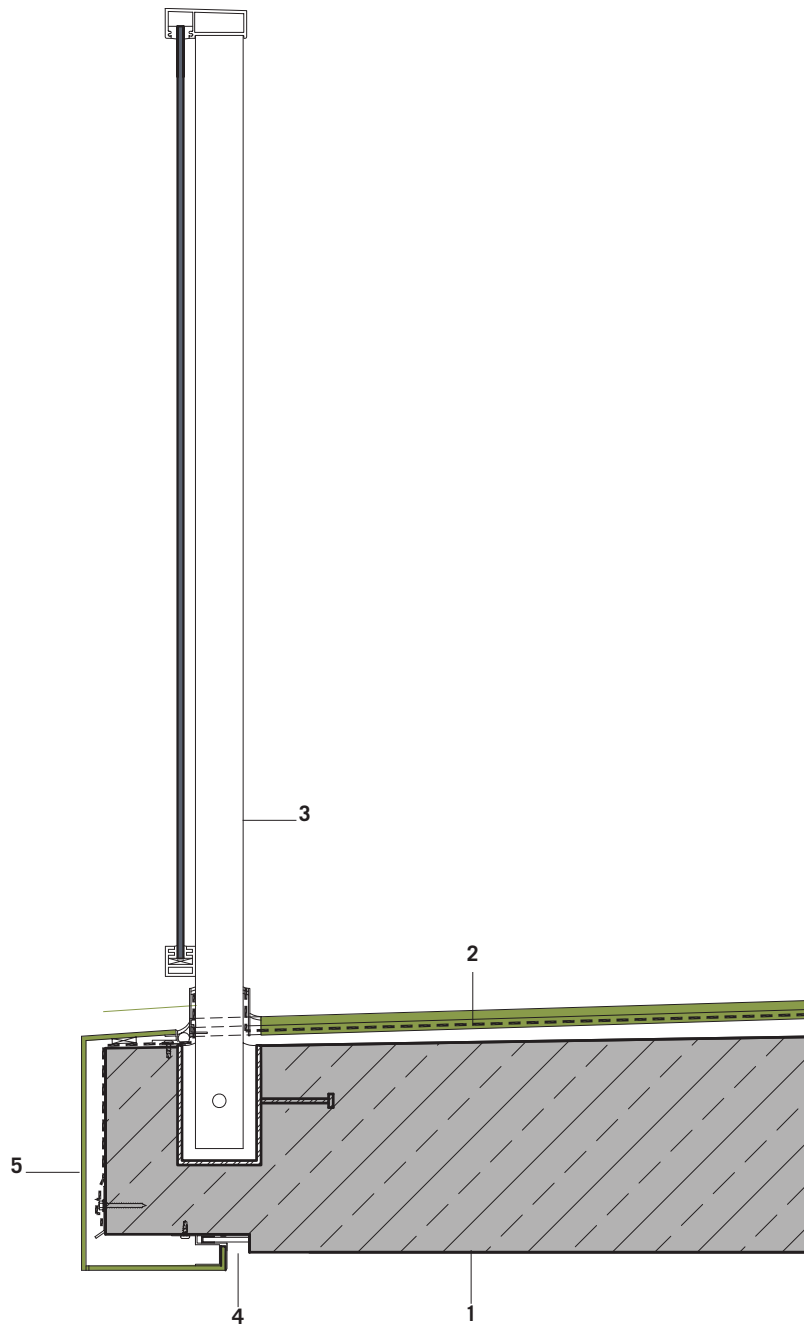

- 1 Cast in place concrete balcony floor (no FRR required); Painted or exposed surface
- 2 Finish floor with waterproof membrane
- 3 Vertical supports with glass guard rail
- 4 Drip edge
- 5 Metal fascia

**Typical concrete tower typical balcony rail**

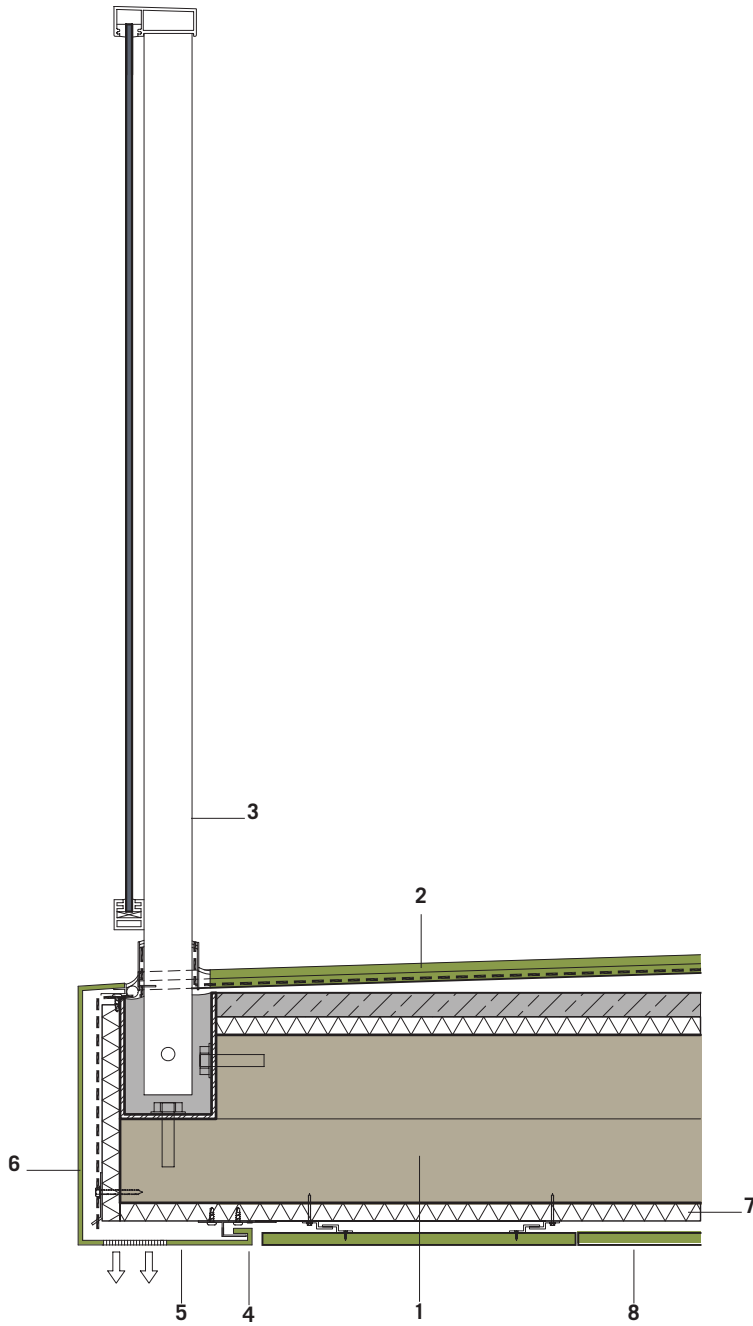

- 1 Mass timber structural panels (no FRR required)
- 2 Finish floor with waterproof membrane on concrete topping
- 3 Vertical supports with glass guard rail
- 4 Drip edge
- 5 Exterior soffit with prefinished perforated vent.
- 6 Metal fascia
- 7 Insulation
- 8 Non-combustible cladding

**Tall wood case study typical balcony rail**

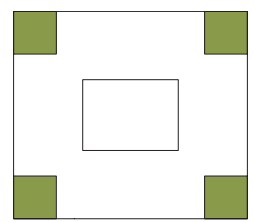

1

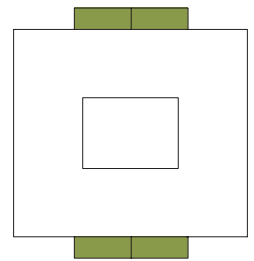

2

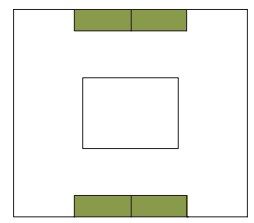

3

- 1 Corner balcony configurations
- 2 Cantilevered balcony
- 3 Recessed balcony

**Possible balcony configurations**

Core Study: Stair

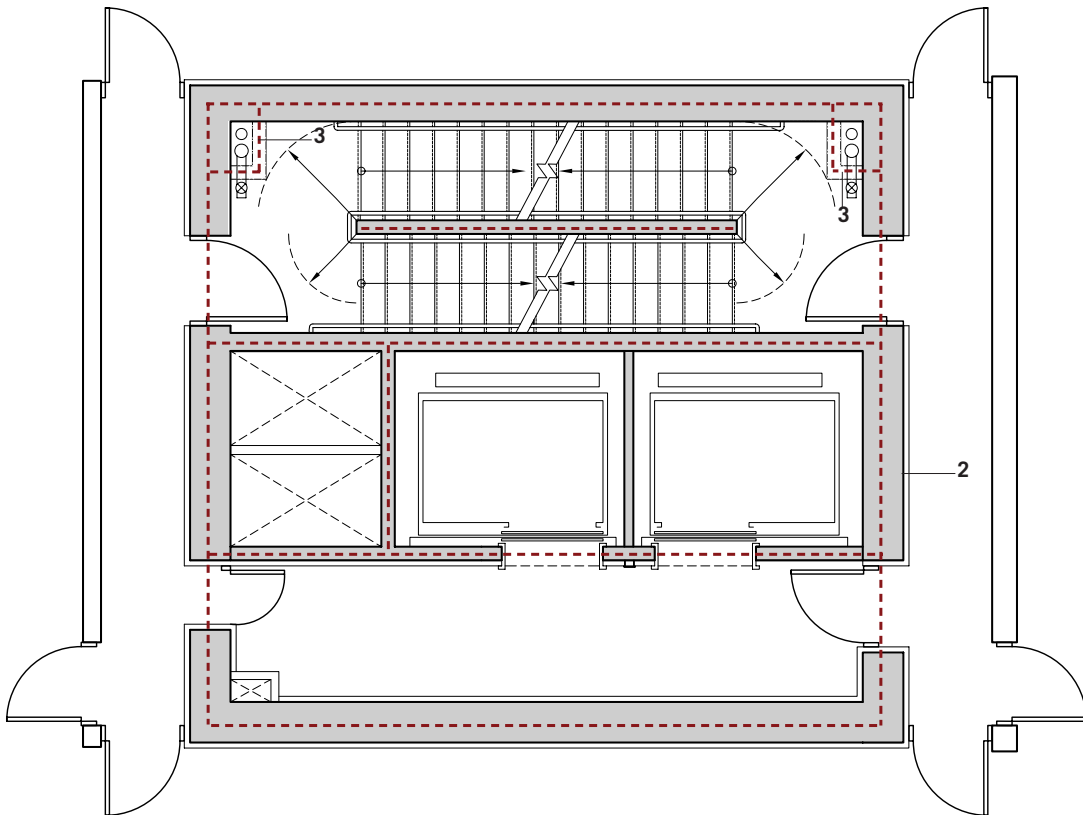
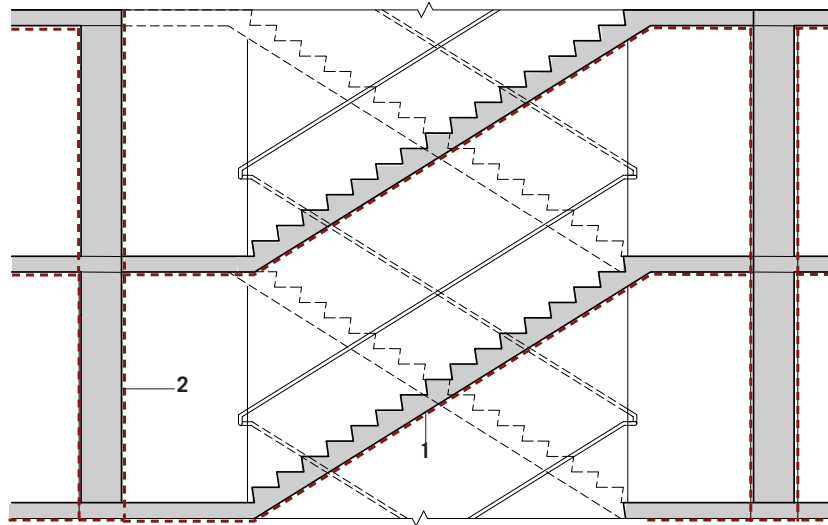

- 1 Cast in place concrete stair (2HR FRR)
- 2 Cast in place concrete wall (2HR FRR)
- 3 Stand pipe enclosed (2HR FRR)

Typical concrete tower typical core with scissor stair

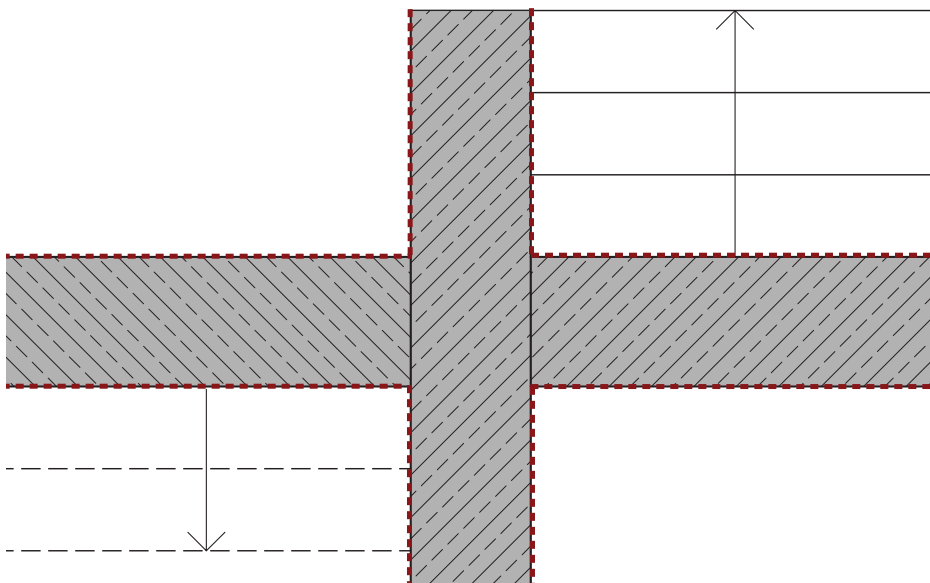
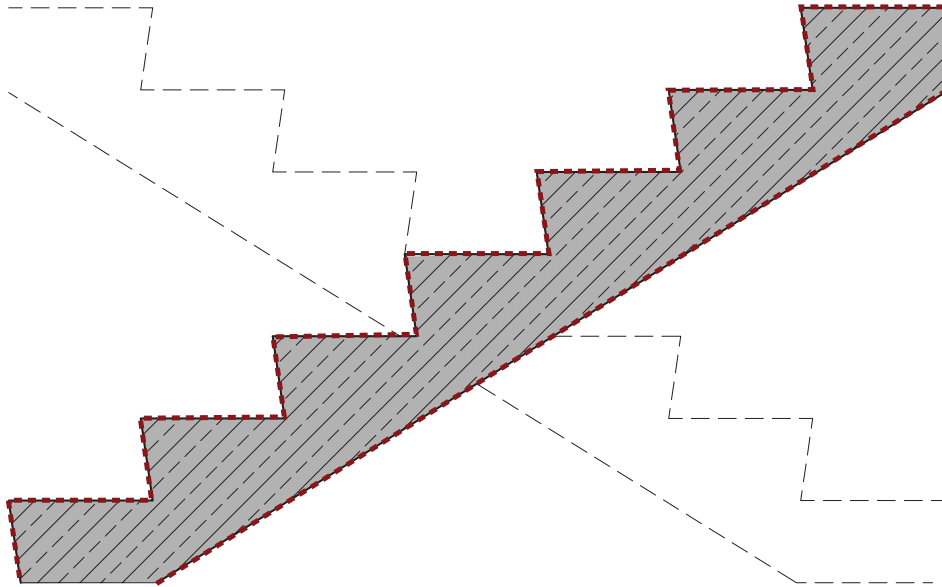

- 1 Cast in place concrete stair (2HR FRR)
- 2 Cast in place concrete wall (2HR FRR)

**Typical concrete tower typical core scissor stair**

Core Study: Stair

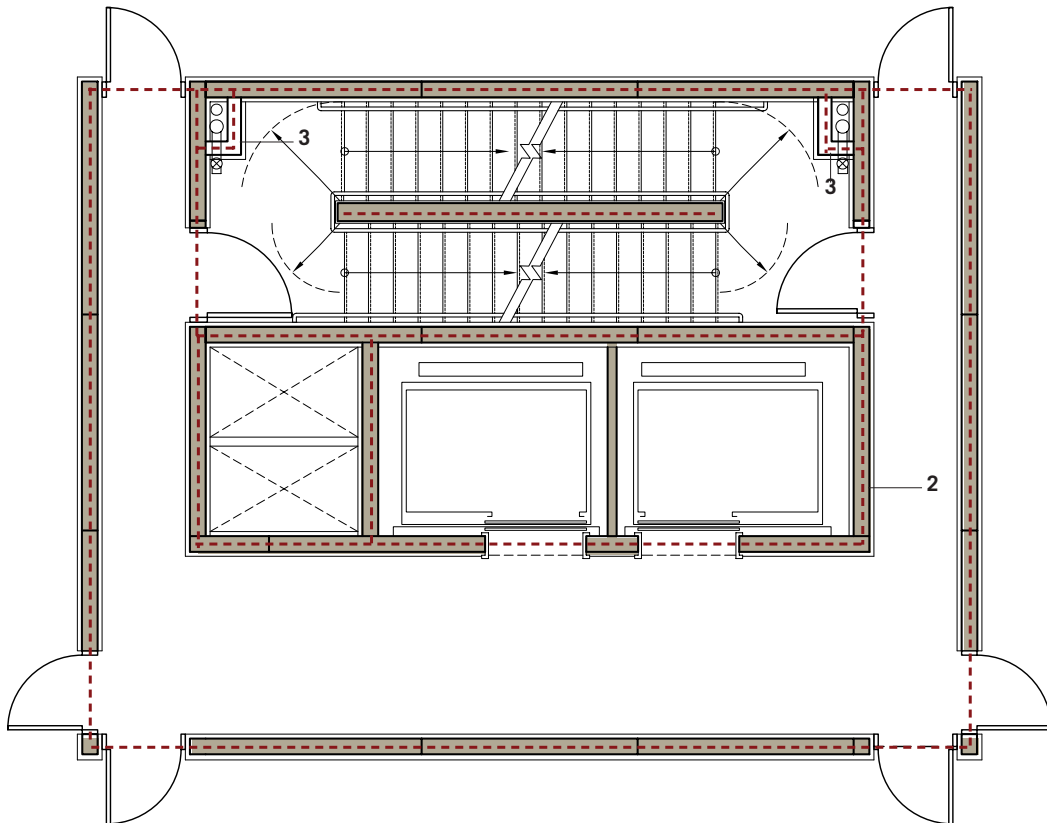
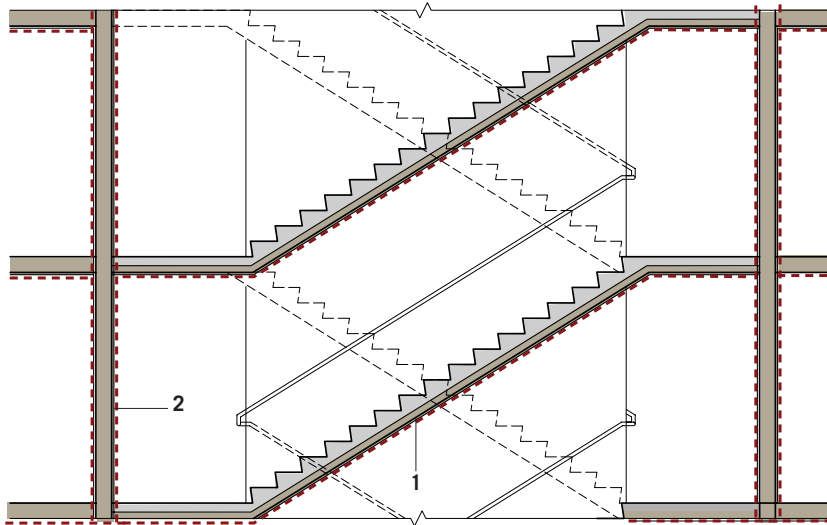

- 1 Stair: 2 Layer 5/8" type X gypsum board + Mass timber structural panels + concrete treads (2HR FRR)
- 2 Wall: 2 Layer 5/8" type X gypsum board + Mass timber structural panels (2HR FRR)
- 3 Stand pipe encasement: 2 Layer 5/8" type X gypsum board + steel studs (2HR FRR)

Tall wood case study tower typical core with scissor stair

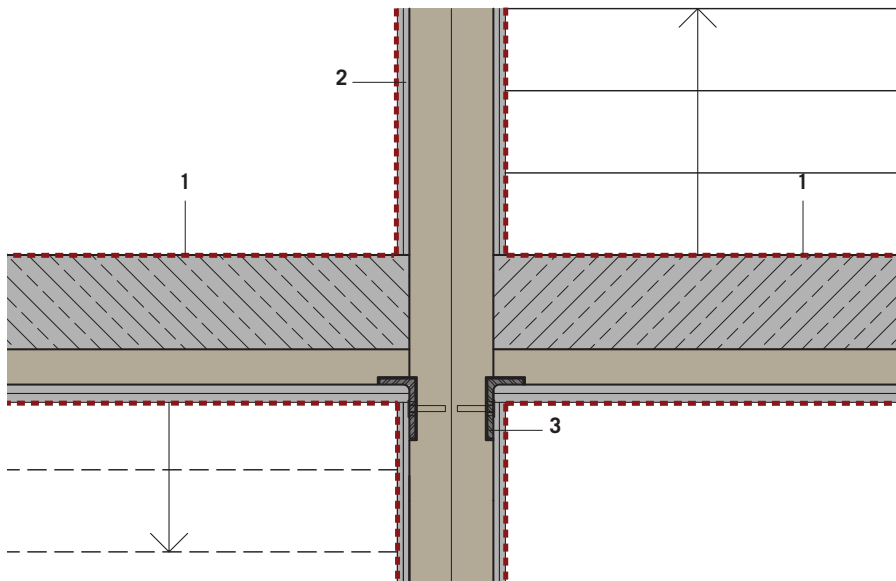
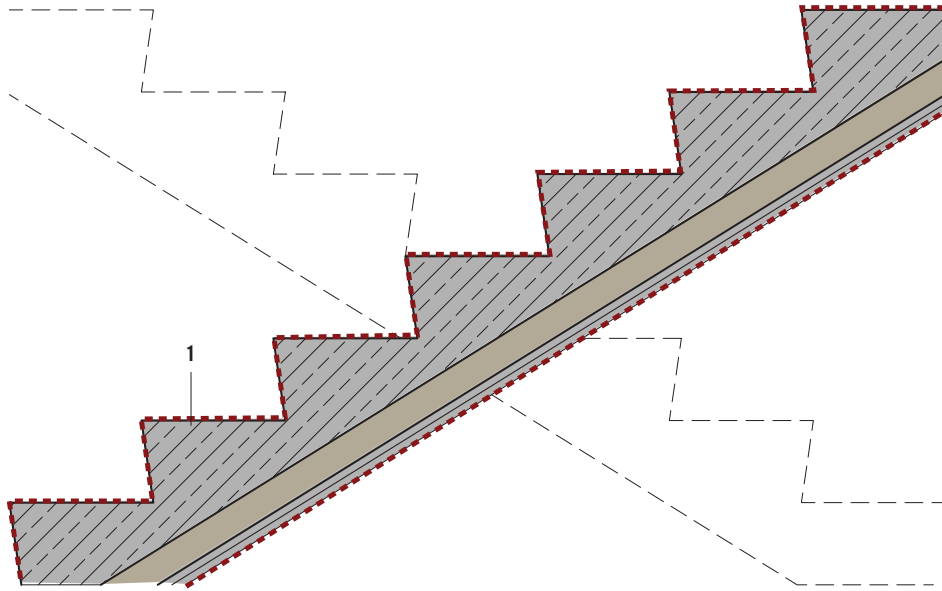

- 1 Stair: Mass timber structural panels + 2 Layer 5/8" type X gypsum board + concrete stair form (2HR FRR)
- 2 Wall: Mass timber structural panels + 2 Layer 5/8" type X gypsum board + concrete topping (2HR FRR)
- 3 Recessed steel ledger

**Tall wood case study typical core scissor stair**

**Core Study: Stair**

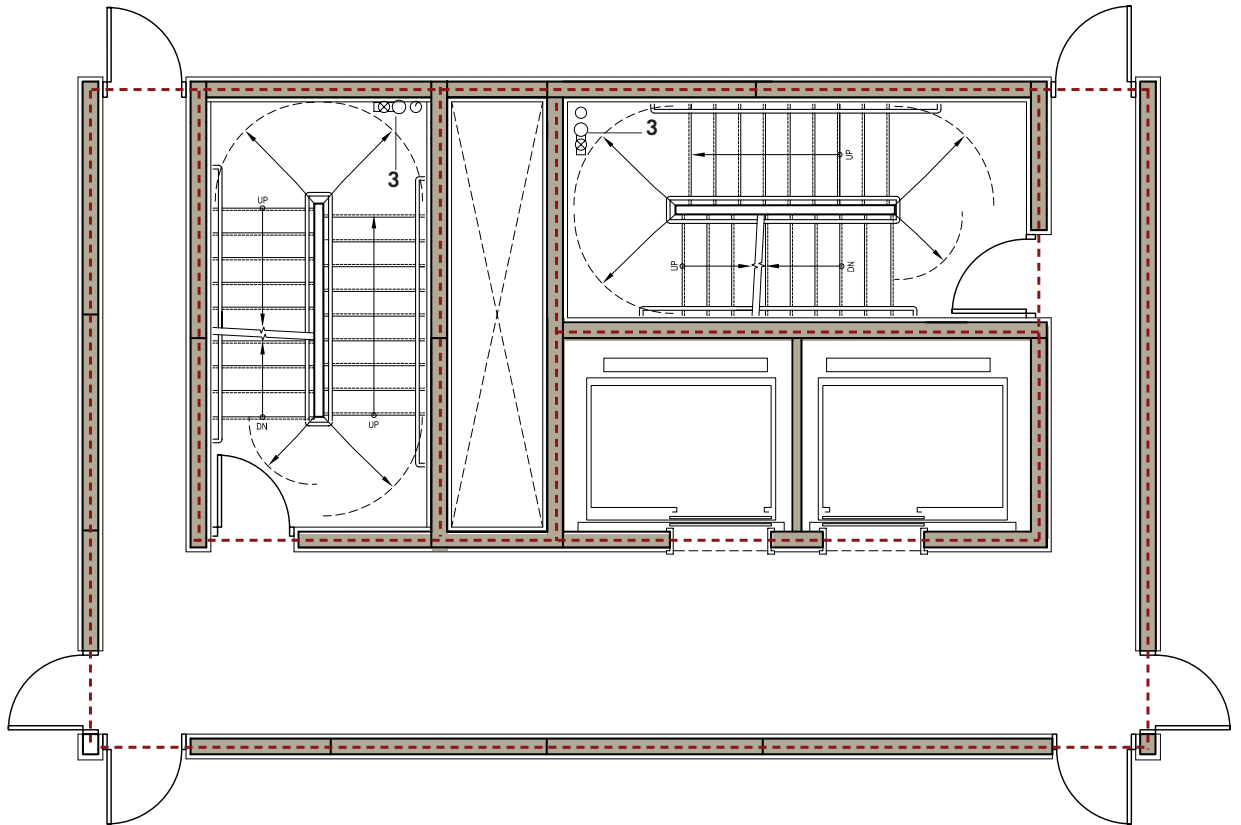
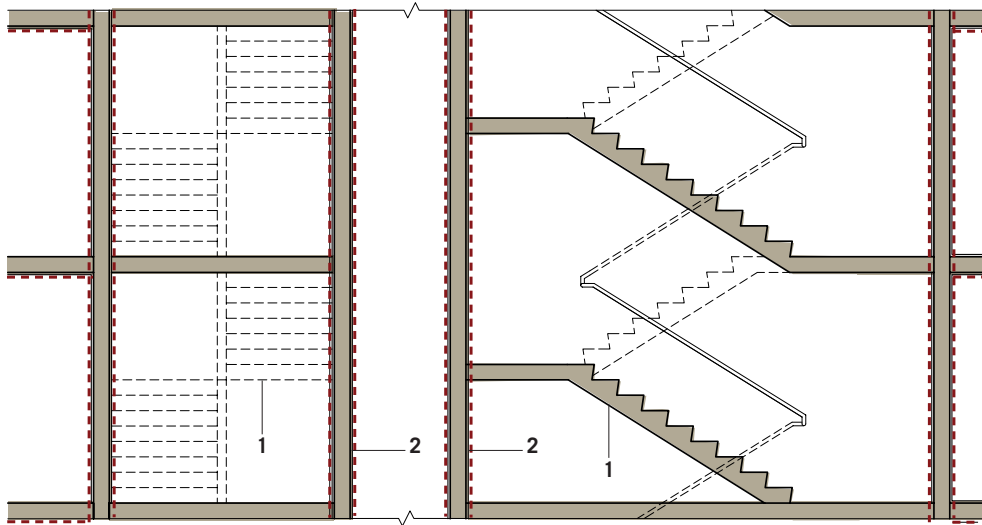

- 1 Stair: Mass timber structural panels + concrete topping or equivalent wear surface
- 2 Wall: 2 Layer 5/8" type X gypsum board + Mass timber structural panels (2HR FRR)
- 3 Stand pipe: exposed

**Tall wood case study tower typical core with two separate exit stairs**

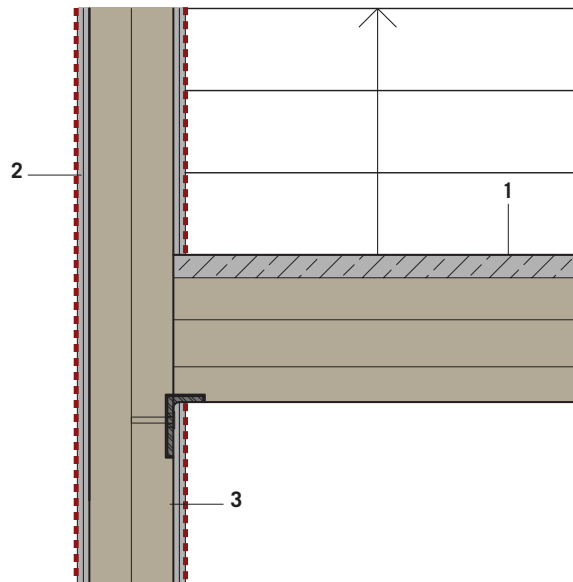
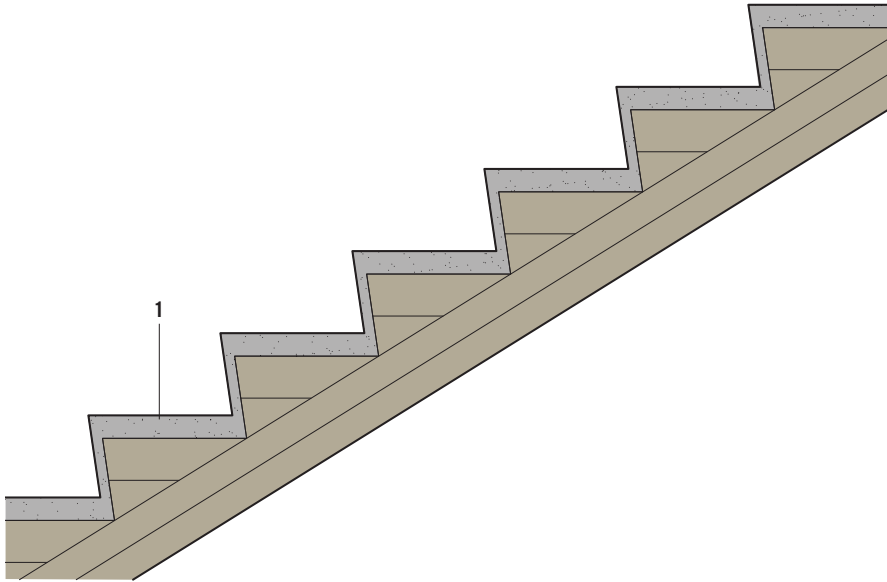

- 1 Stair: Multi-layer LVL or LSL + concrete topping (No FRR required)
- 2 Wall: Mass timber structural panels + 2 Layer 5/8" type X gypsum board both sides (2HR FRR)
- 3 Recessed steel ledger

**Tall wood case study typical core single stair**



## Core Study: Elevator

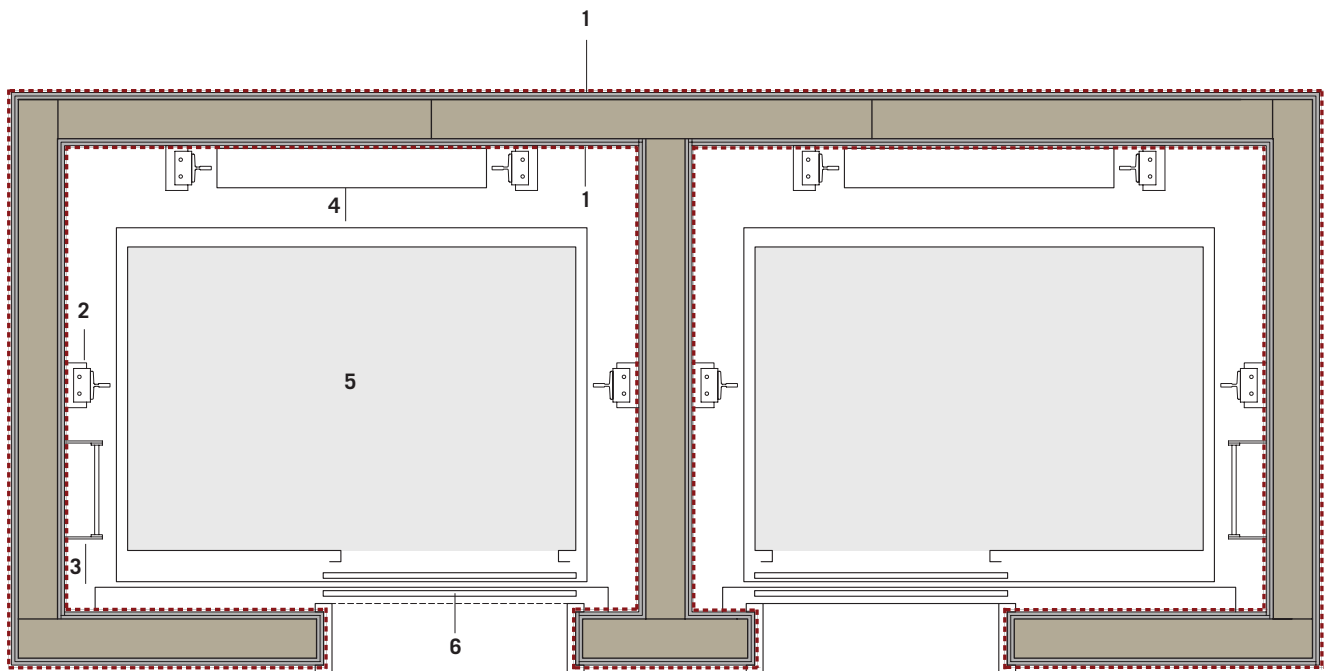

- 1 Mass timber structural panels + 2 Layer 5/8" type X gypsum board on each side of shaft wall (2HR FFR)
- 2 Elevator rail and bracket
- 3 Pit ladder
- 4 Elevator lift
- 5 Elevator cab
- 6 Elevator door

## Tall wood case study elevator plan

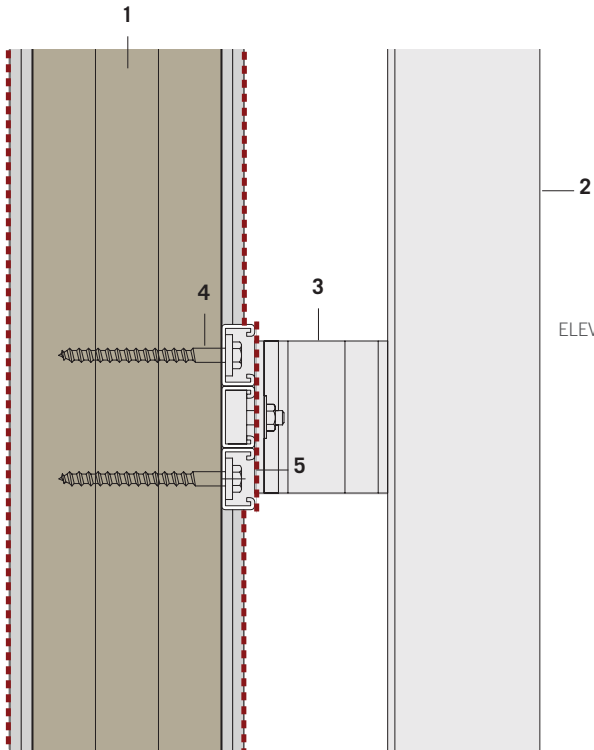

ELEVATOR SHAFT SIDE

- 1 Mass timber structural panels + 2 Layer 5/8" type X gypsum board on each side of shaft wall (2HR FRR)
- 2 Elevator rail
- 3 Elevator rail support bracket
- 4 Bracket connection to structural wall
- 5 Joint compound. Fire-rated.

Note: Detail illustrating fire protection of shaft wall. Various elevator manufacturers offer proprietary rail support brackets. As with typical practice, each elevator must be designed and engineered with the specified elevator manufacturer. Support bracket in illustration from Schindler Elevator Hydraulic Hoisting Guidelines.

**Tall wood case study elevator rail at shaft wall detail**

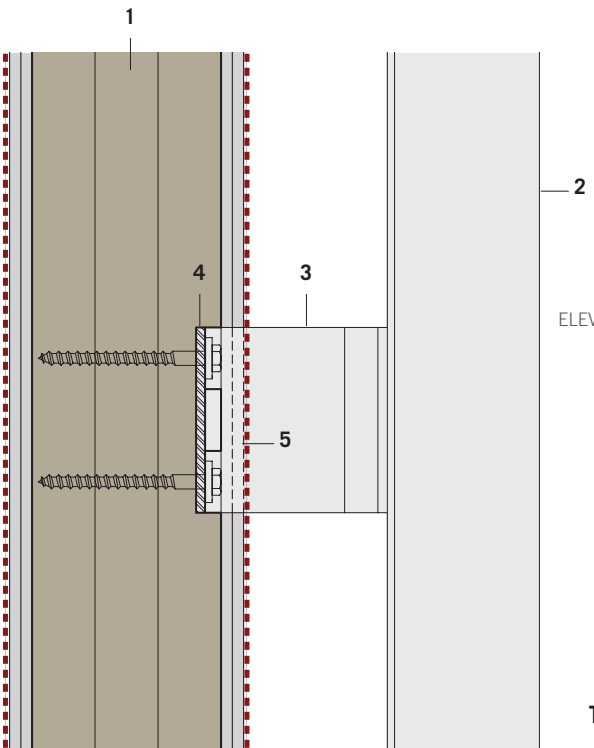

ELEVATOR SHAFT SIDE

- 1 Mass timber structural panels + 2 Layer 5/8" type X gypsum board on each side of shaft wall (2HR FFR)
- 2 Elevator rail
- 3 Elevator rail support bracket
- 4 Bracket connection to structural wall. Recessed plate to allow gypsum to run continuously over
- 5 Gypsum board to run over bracket connection. Firestop gaps

**Tall wood case study elevator rail at shaft wall detail. Alternate detail.**

## Typical Charring Details

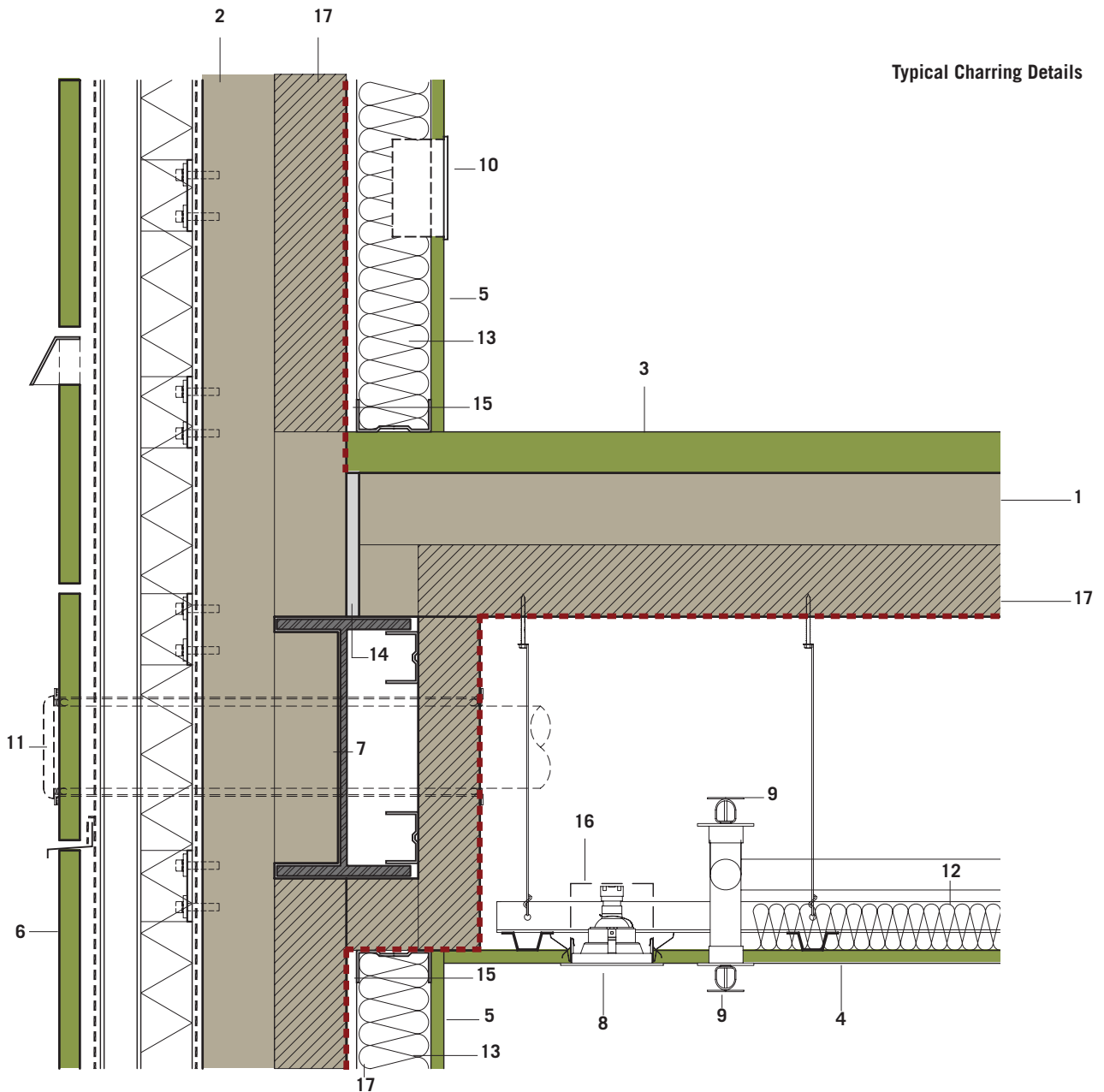

- 1 \*\* Mass timber structural panels + sacrificial layer
- 2 \*\* Mass timber structural panels + sacrificial layer
- 3 Finish floor (refer to floor assembly table)
- 4 Finish ceiling: 1 layer 5/8" gypsum board
- 5 Finish wall: 1 layer 5/8" gypsum board
- 6 Facade (non-combustible)
- 7 Steel beam
- 8 Pot light
- 9 Sprinkler up and down (combustible concealed space)
- 10 Electrical outlet
- 11 Exhaust penetration with fire stopping

- 12 2" loose mineral wool insulation for sound absorption (ceiling)
- 13 2" loose mineral wool insulation for sound absorption (wall)
- 14 Gasket to reduce sound transmission between floor and wall
- 15 Gap between wood and stud to reduce sound transmission
- 16 Back boxes for light fixtures to reduce sound transmission
- 17 \*\* Ceiling and floor: sacrificial fire protection layer (LVL, LSL, CLT).

\*\* Charring rates vary depending on timber type, moisture, density and species. The charring rate of 0.65mm/min is the generally accepted average. Refer to Section 3.7 Fire Performance for additional information on charring rate.

### Tall wood case study floor and wall section at exterior wall illustrating charring concept

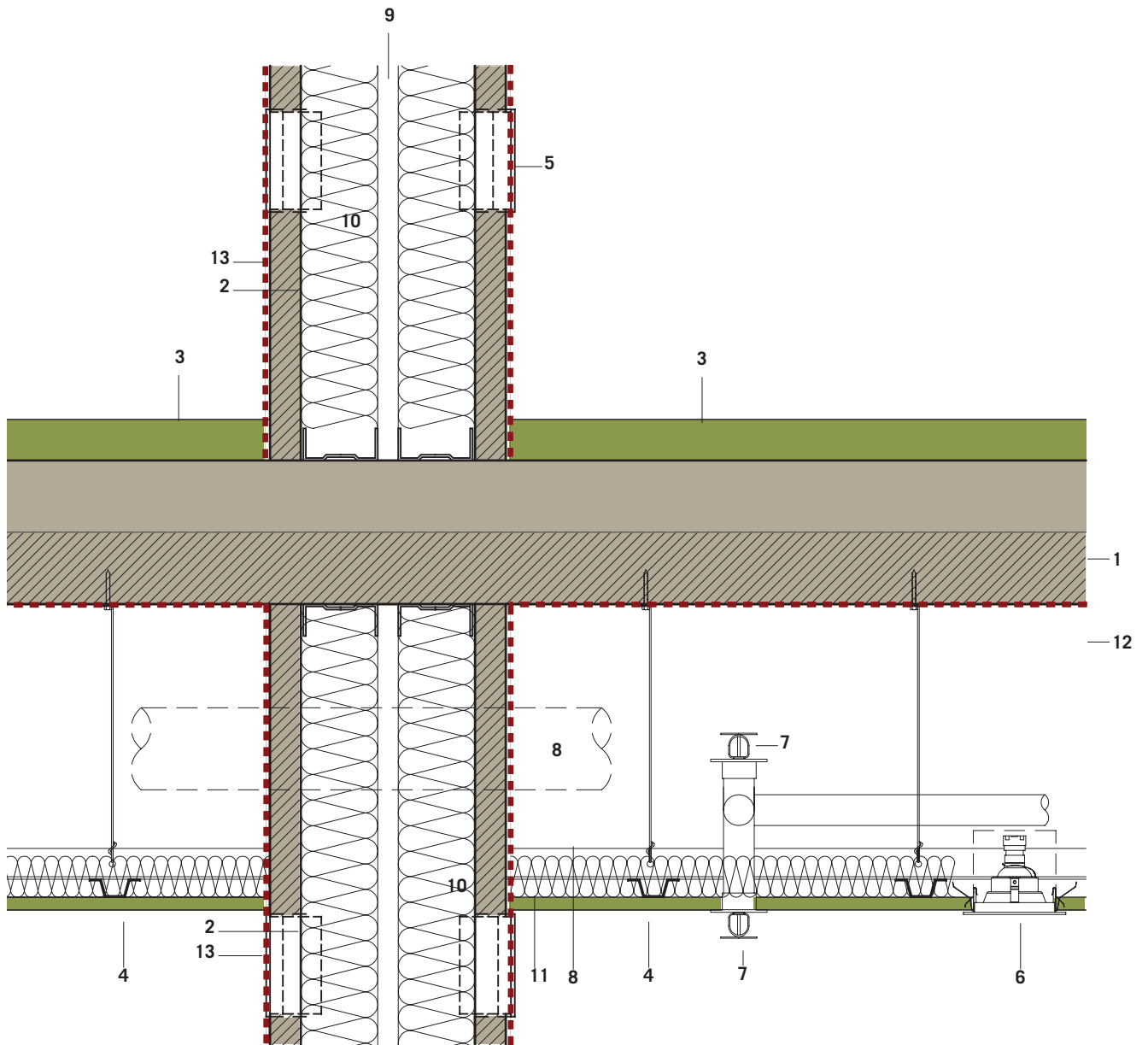

- 1 \*\*Mass timber structural panels + sacrificial layer
- 2 \*\*Double steel stud wall + sacrificial layer
- 3 Finish floor (refer to floor assembly details)
- 4 Finish ceiling: 1 layer 5/8" gypsum board
- 5 Electrical outlet
- 6 Pot light
- 7 Sprinkler up and down (combustible concealed space)
- 8 Duct - fire stopped
- 9 Air space between walls to reduce sound transmission
- 10 Mineral wool insulation for sound absorption
- 11 2" loose mineral wool insulation for sound absorption

- 12 \*\*Ceiling: sacrificial fire protection layer (LVL, LSL, CLT).  
LVL - 0.65 mm/min. 2HR FRR = 78mm [3"]
- 13 \*\*/\*\*Wall: sacrificial fire protection layer (LVL, LSL, CLT).  
0.65 mm/min. 1HR FRR = 39mm [ 1 1/2"]

\*\* Charring rates vary depending on timber type, moisture, density and species. The charring rate of 0.65mm/min is the generally accepted average. Refer to Section 3.7 Fire Performance for additional information on charring rate.

\*\*\* Interior finish: exposed wood paneling subject to flame-spread rating and smoke developed classification code requirements. Refer to Section 3.7 Fire Performance for additional information on flamespread, smoke classification and interior finishes.

\*\*\*\* CLT is recommended as finishing if using a sacrificial layer.

**Tall wood case study typical non-load bearing interior partition between units illustrating charring concept**

**Typical Charring Details**

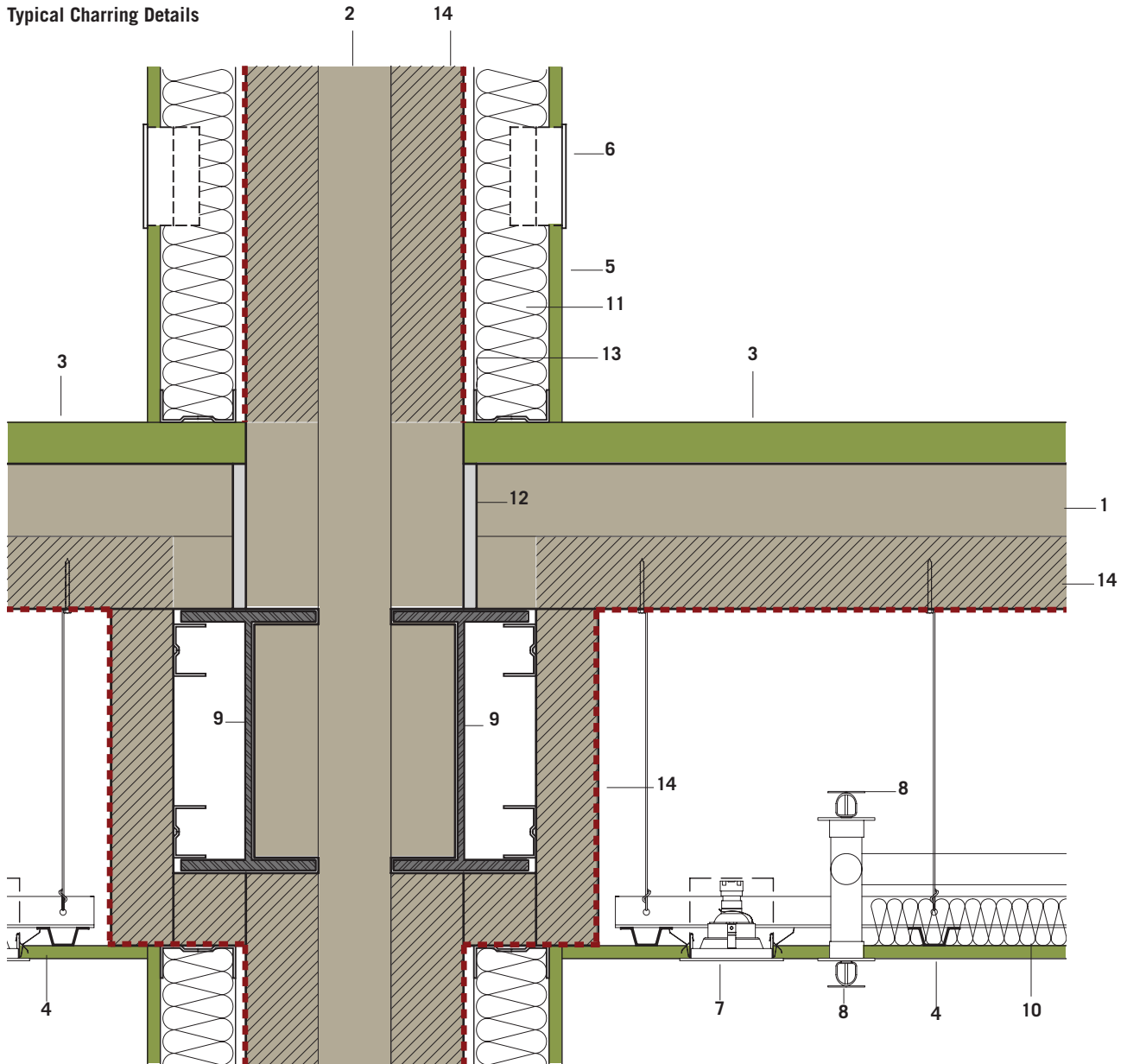

- |    |   |    |  |
|----|---|----|--|
| 1  | **Mass timber structural panels + sacrificial layer             | 12 | Gasket to reduce sound transmission between floor and walls  |
| 2  | **Mass timber structural panels + sacrificial layer             | 13 | Gap between wood and stud to reduce sound transmission   |
| 3  | Finish floor: (refer to floor assembly details)                 | 14 | **Ceiling and floor: sacrificial fire protection layer (LVL, LSL, CLT).  |
| 4  | Finish ceiling: 1 layer 5/8" gypsum board                       | ** | Charring rates vary depending on moisture, density, species etc. The charring rate of 0.65mm/min is the generally accepted average. Refer to Section 3.7 Fire Performance for additional information on charring rate. |
| 5  | Furring and finish wall: 1 layer 5/8" gypsum board              |    |  |
| 6  | Electrical outlet   |    |  |
| 7  | Pot light   |    |  |
| 8  | Sprinkler up and down (combustible concealed space)             |    |  |
| 9  | Steel beam  |    |  |
| 10 | 2" loose mineral wool insulation for sound absorption (ceiling) |    |  |
| 11 | 2" loose mineral wool insulation for sound absorption (wall)    |    |  |

**Tall wood case study typical load bearing interior partition illustrating charring concept**

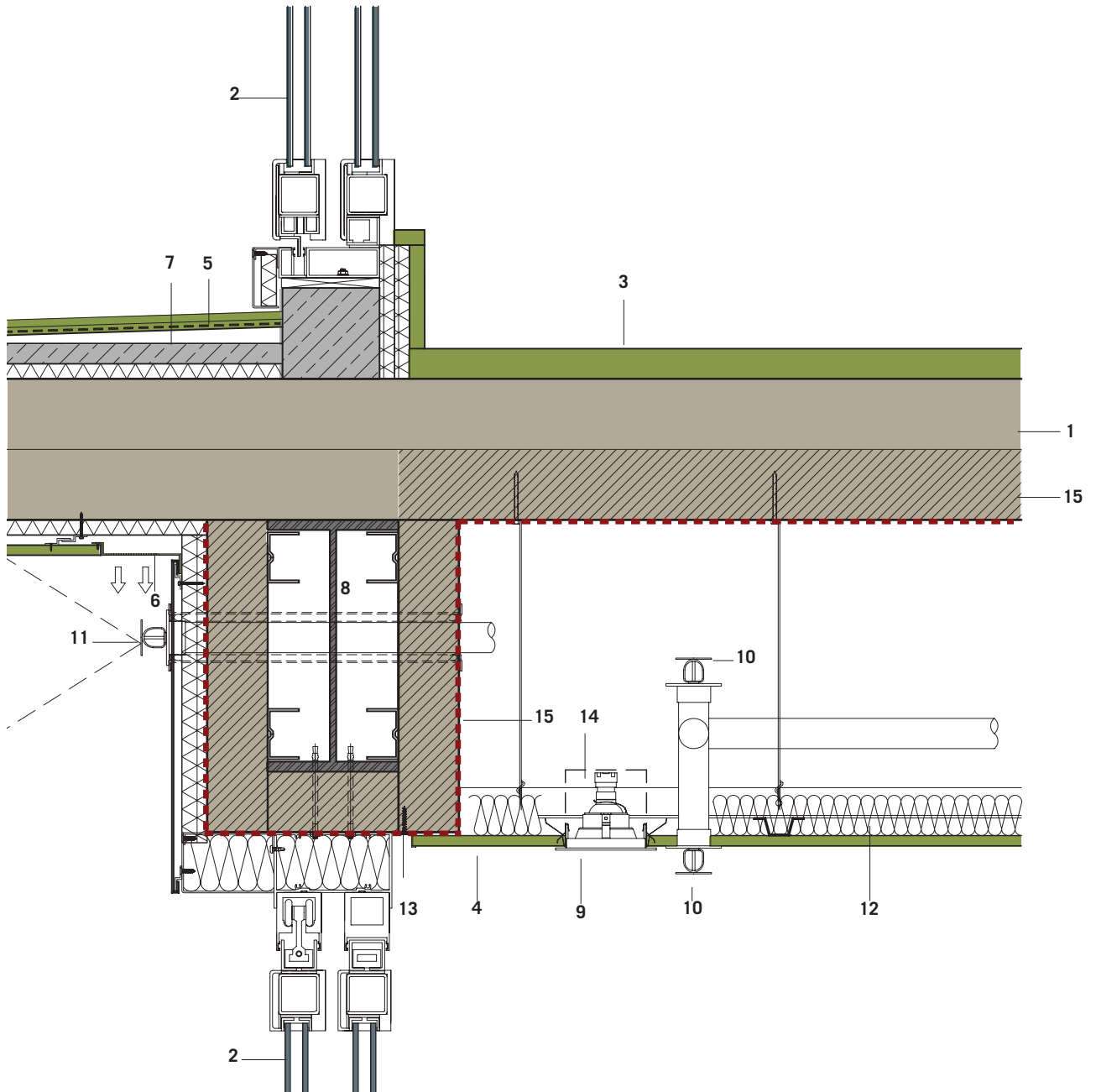

- |    |   |    |  |
|----|---|----|--|
| 1  | **Mass timber structural panels + sacrificial layer       | 12 | 2" loose mineral wool insulation for sound absorption  |
| 2  | Balcony door  | 13 | Acoustic seal  |
| 3  | Finish floor (refer to floor assembly details)            | 14 | Back boxes for light fixtures to reduce sound transmission   |
| 4  | Finish ceiling: 1 layer 5/8" gypsum board                 | 15 | **Ceiling and floor: sacrificial fire protection layer (LVL, LSL, CLT).  |
| 5  | Finish floor balcony (sloping waterproofing)              |    | **   |
| 6  | Exterior soffit with prefinished perforated vent.         |    | Charring rates vary depending on moisture, density, species etc. The charring rate of 0.65mm/min is the generally accepted average. Refer to Section 3.7 Fire Performance for additional information on charring rate. |
| 7  | Concrete topping and curb                                 |    |  |
| 8  | Steel beam  |    |  |
| 9  | Pot light   |    |  |
| 10 | Sprinkler up and down (combustible concealed space)       |    |  |
| 11 | Dryhead sprinkler with fire stopping (up to 10' outboard) |    |  |

**Tall wood case study sliding door section at balcony illustrating charring concept**

## Typical Envelope Details

- 1 Cast in place concrete floor (2HR FRR)
- 2 Finish floor
- 3 Finish ceiling: 1 layer 5/8" gypsum board

### Curtain Wall

- 4 Wind driven rain
- 5 Vision glass (double or triple glazed)
- 6 Spandrel panel (double glazed)
- 7 Drainage and pressure equalization opening + drip edge
- 8 Non-combustible insulation
- 9 Backpan (air / vapour barrier) + drainage
- 10 Floor anchor
- 11 Mullion

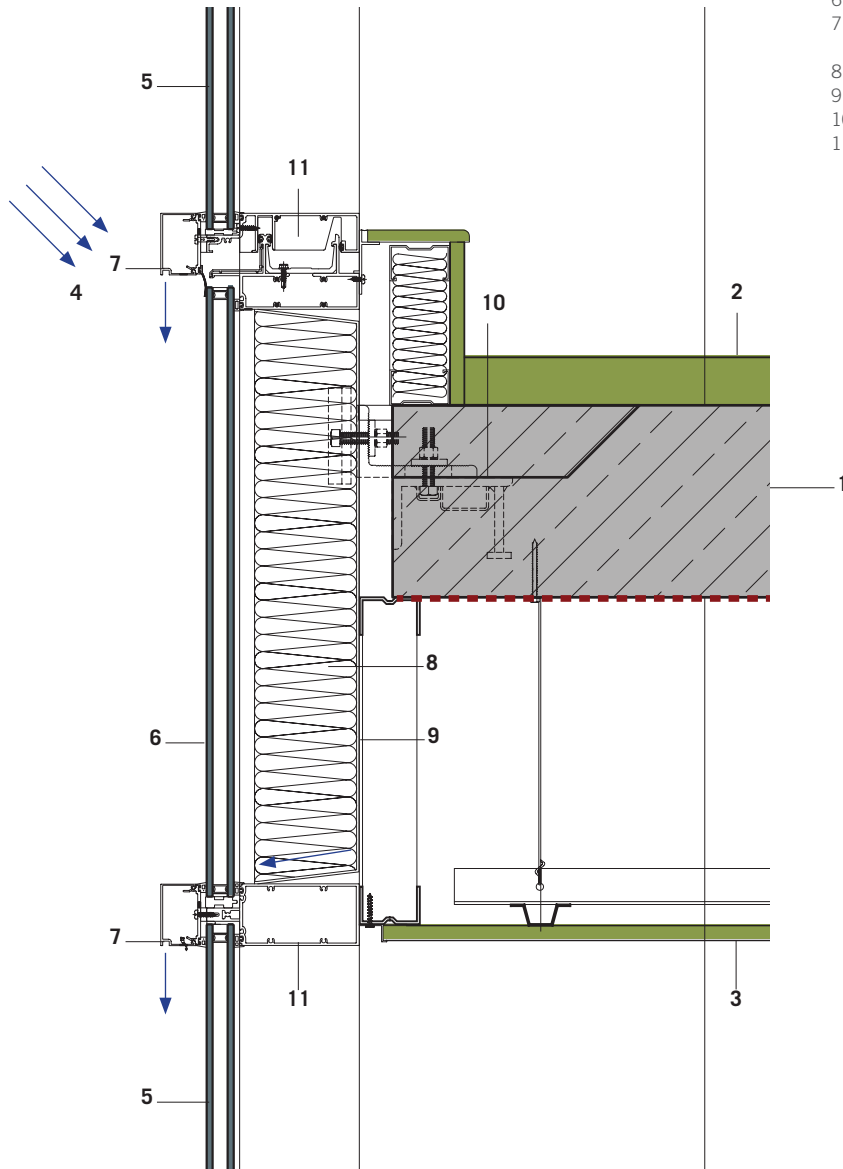

Typical concrete tower floor and wall section at curtain wall

- 1 Mass timber structural panels + 2 Layer 5/8" gypsum board underside only (2HR FFR)
- 2 Glulam beam + 2 Layer 5/8" type X gypsum board (2HR FFR)
- 3 Finish floor (refer to floor assembly details)
- 4 Finish ceiling: 1 layer 5/8" gypsum board

**Curtain Wall**

- 5 Wind driven rain
- 6 Vision glass (double or triple glazed)
- 7 Spandrel panel (double glazed)
- 8 Drainage and pressure equalization opening + drip edge
- 9 Non-combustible insulation
- 10 Backpan (air / vapour barrier)
- 11 Floor anchor
- 12 Mullion

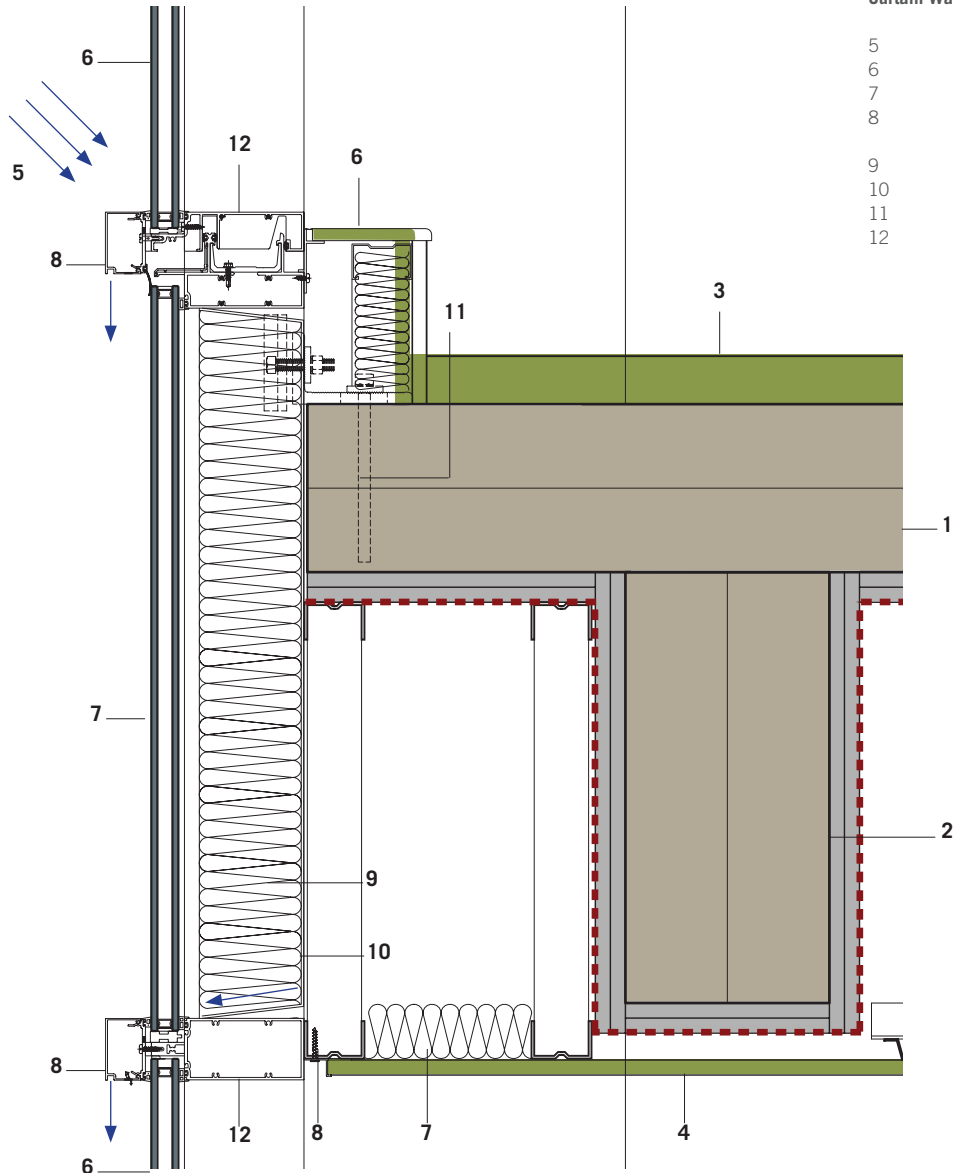

Tall wood case study floor and wall section at exterior wall



## Typical Envelope Details

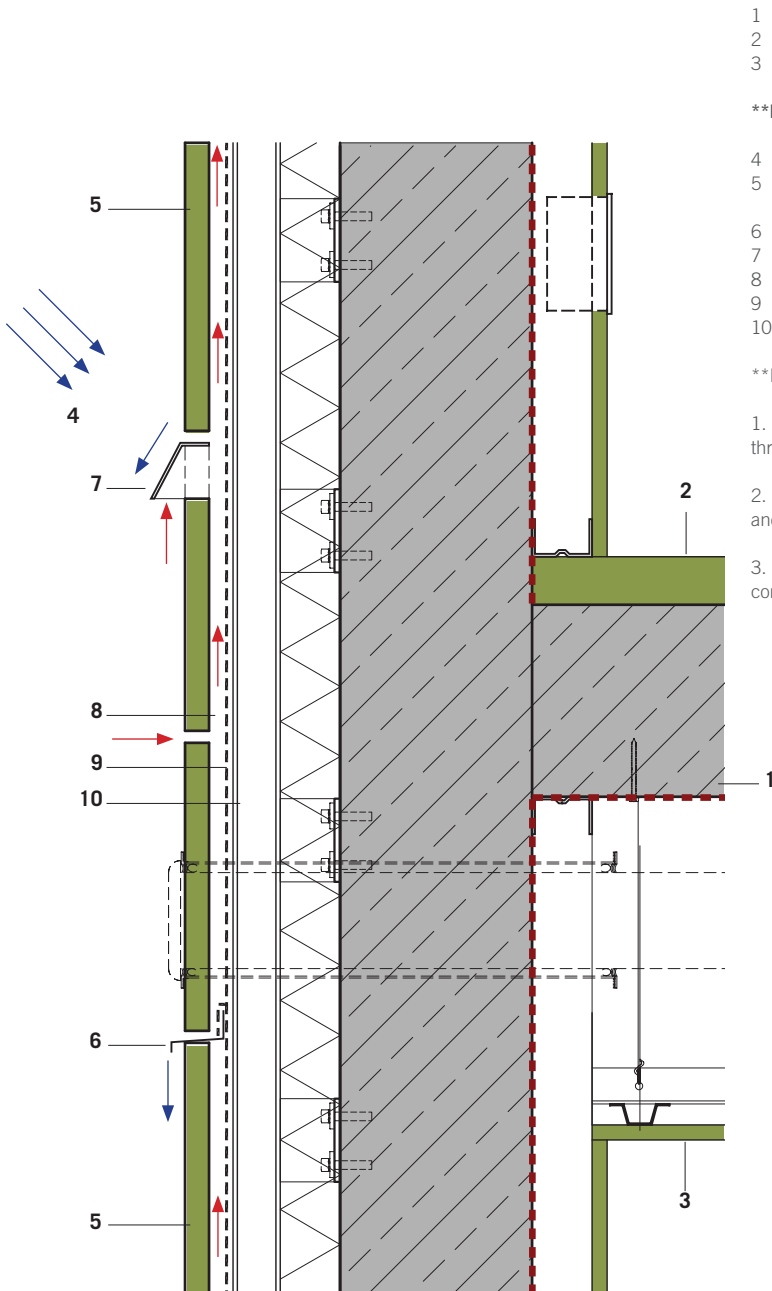

- 1 Cast in place concrete floor (2HR FRR)
- 2 Finish floor
- 3 Finish ceiling: 1 layer 5/8" gypsum board

### \*\*Pressure Equalized Rainscreen Wall

- 4 Wind driven rain
- 5 Non-combustible cladding mechanically anchored as required with open joints.
- 6 Flashing with drip edge. Pressure equalization opening.
- 7 Protected vent. Pressure equalization opening.
- 8 Drainage cavity for back venting
- 9 Drainage plane
- 10 Non-combustible insulation

### \*\*Notes:

- 1. Pressure equalization results in reduced incidental water ingress through cladding, collected at drainage plane and returned to exterior
- 2. Back venting of cladding allows drying by means of air movement and vapour diffusion
- 3. Open joints and vents at top and bottom combined with compartmentalization reduce pressure difference across cladding

Typical concrete tower floor and wall section at exterior wall

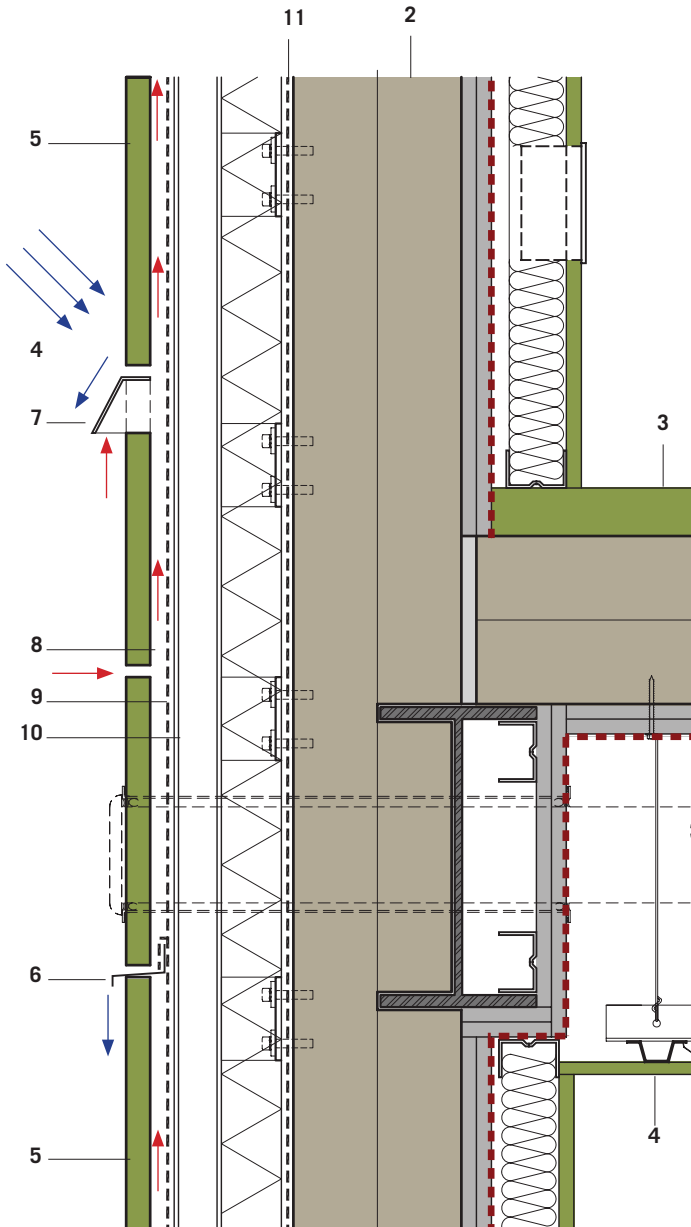

- 1 Mass timber structural panels + 2 Layer 5/8" type X gypsum board underside only (2HR FFR)
- 2 Mass timber structural panels + 2 Layer 5/8" type X gypsum board inside only (2HR FFR)
- 3 Finish floor (refer to floor assembly details)
- 4 Finish ceiling: 1 layer 5/8" gypsum board

**\*\*Pressure Equalized Rainscreen Wall**

- 4 Wind driven rain
- 5 Non-combustible cladding mechanically anchored as required with open joints.
- 6 Flashing with drip edge. Pressure equalization opening.
- 7 Protected vent. Pressure equalization opening.
- 8 Drainage cavity for back venting
- 9 Drainage plane
- 10 Non-combustible insulation
- 11 Waterproofing layer

**\*\*Notes:**

- 1. Pressure equalization results in reduced incidental water ingress through cladding, collected at drainage plane and returned to exterior
- 2. Back venting of cladding allows drying by means of air movement and vapour diffusion
- 3. Open joints and vents at top and bottom combined with compartmentalization reduce pressure difference across cladding

**Tall wood case study floor and wall section at exterior wall**

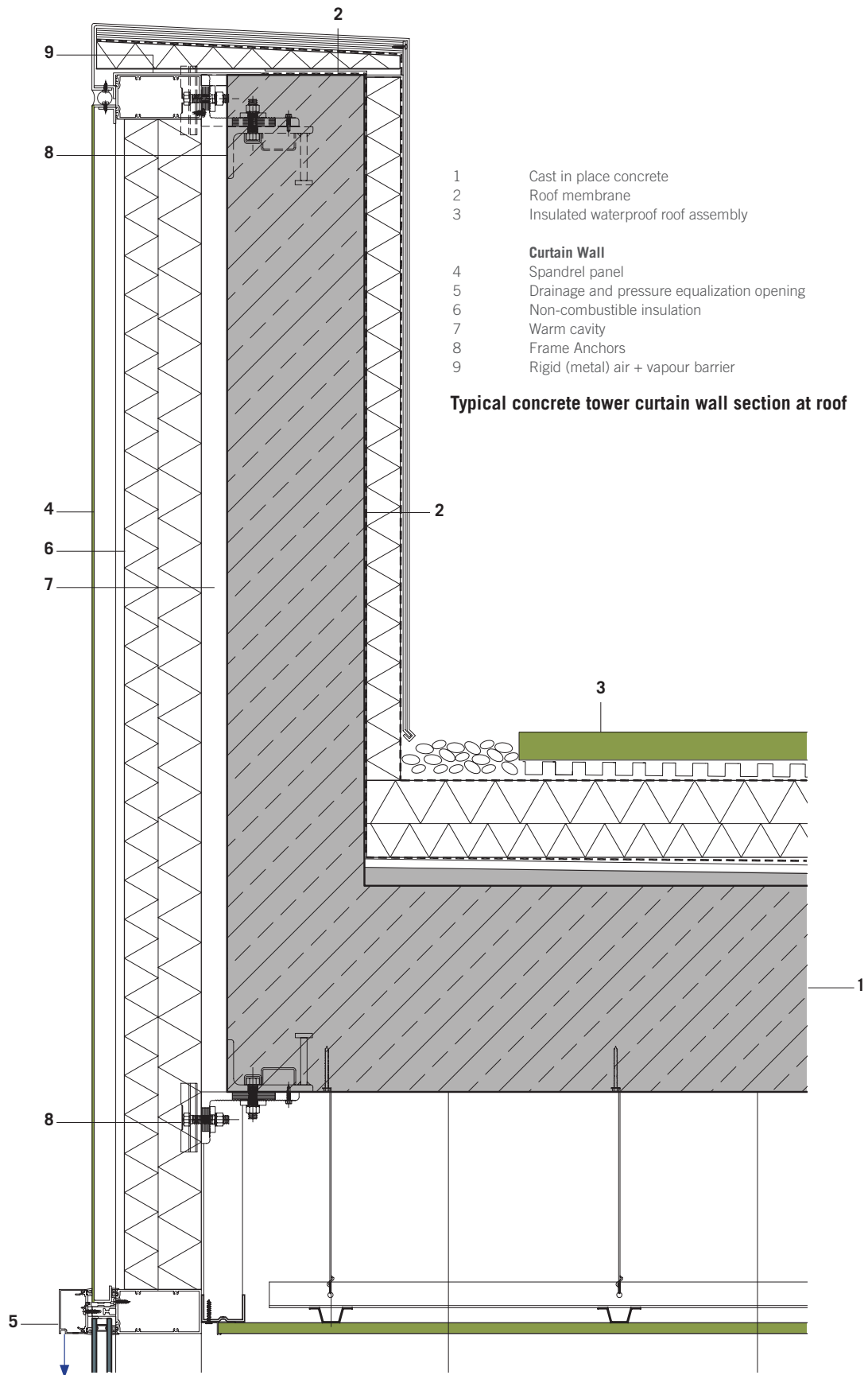

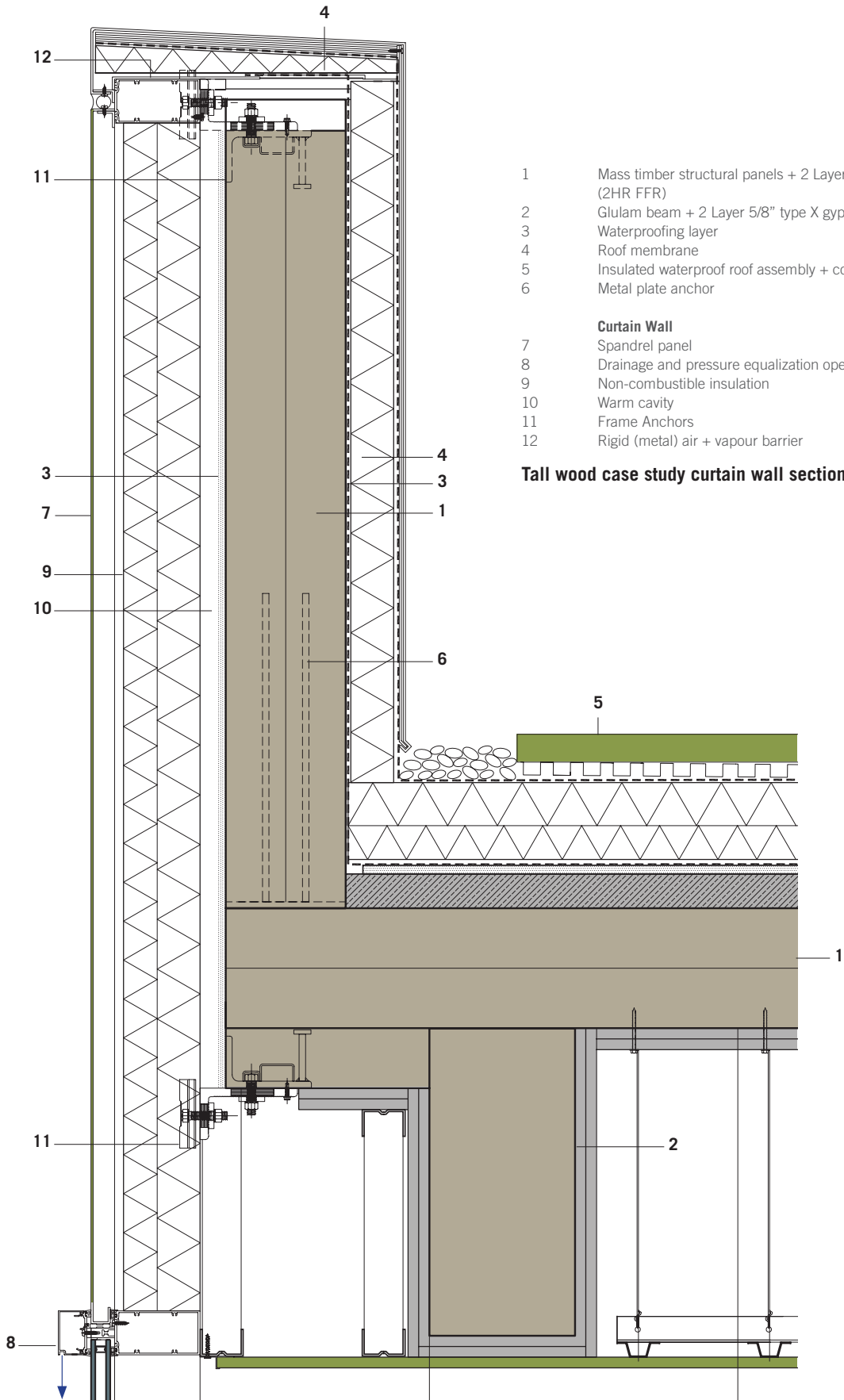

- 1 Mass timber structural panels + 2 Layer 5/8" type X gypsum board (2HR FFR)
- 2 Glulam beam + 2 Layer 5/8" type X gypsum board (2HR FFR)
- 3 Waterproofing layer
- 4 Roof membrane
- 5 Insulated waterproof roof assembly + concrete topping
- 6 Metal plate anchor

- Curtain Wall**
- 7 Spandrel panel
  - 8 Drainage and pressure equalization opening
  - 9 Non-combustible insulation
  - 10 Warm cavity
  - 11 Frame Anchors
  - 12 Rigid (metal) air + vapour barrier

**Tall wood case study curtain wall section at roof**

## 3.12 Cost Analysis

### Project Cost Summary

To develop a comprehensive overview of the cost implications for each design we reviewed all project costs applicable to each option (see Appendix B).

To show a unit like-for-like assessment, we extrapolated costs for the main comparative sections of the different forms of construction. The table below summarizes these cost differences.

### Cost Findings

The cost analysis calculated the project costs for both 12-storey and 20-storey Timber Frame options utilizing both the charring and the encapsulation approach to fire protection. The results were then applied against various locations within BC to further understand applications to different regions and compared them to a benchmark Concrete Frame building of similar size.

The estimated costs were developed based on preliminary design drawings that are demonstrated in this document. The estimates offer a reasonable current day cost envelope that could form the basis for developing a project design. More precise estimates based on more detailed design information would most likely vary from this baseline.

The table below sets out the comparative costs of the various options we investigated.

Item	Concrete	Timber Panels	Difference
Structural Walls (Including Fire Rating)	\$39/Sq.ft	\$29/Sq.ft	26%
Upper Floors (Including Columns, Beams + Topping)	\$22/Sq.ft	\$39/Sq.ft	-43%

Region	12 Storey Concrete Frame	12 Storey FFTT Charring Method	12 Storey FFTT Encapsulation Method	20 Storey Concrete Frame	20 Storey FFTT Charring Method	20 Storey FFTT Encapsulation Method
Vancouver	\$ 17,550,800	\$ 17,518,000	\$ 17,856,200	\$ 30,097,900	\$ 30,297,100	\$ 30,989,900
	<b>\$ / sf \$283</b>	<b>\$283</b>	<b>\$288</b>	<b>\$292</b>	<b>\$294</b>	<b>\$300</b>
Northern BC	\$ 19,832,404	\$ 19,269,800	\$ 19,641,820	\$ 34,010,627	\$ 33,326,810	\$ 34,088,890
	<b>\$ / sf \$320</b>	<b>\$311</b>	<b>\$317</b>	<b>\$330</b>	<b>\$323</b>	<b>\$330</b>
Interior BC	\$ 18,779,356	\$ 18,393,900	\$ 18,749,010	\$ 32,204,753	\$ 31,811,955	\$ 32,539,395
	<b>\$ / sf \$303</b>	<b>\$297</b>	<b>\$303</b>	<b>\$312</b>	<b>\$308</b>	<b>\$315</b>
Fraser	\$ 17,550,800	\$ 17,518,000	\$ 17,856,200	\$ 30,097,900	\$ 30,297,100	\$ 30,989,900
	<b>\$ / sf \$283</b>	<b>\$283</b>	<b>\$288</b>	<b>\$292</b>	<b>\$294</b>	<b>\$300</b>
Vancouver Island	\$ 18,691,602	\$ 18,393,900	\$ 18,749,010	\$ 32,054,264	\$ 31,811,955	\$ 32,539,395
	<b>\$ / sf \$302</b>	<b>\$297</b>	<b>\$303</b>	<b>\$311</b>	<b>\$308</b>	<b>\$315</b>

Note: The 20 storey FFTT option indicated is based on the Option 2 design. The prices shown increases by \$2 /SF for the Option 3 structural approach.

## Project Modelling

### Concrete Building

The proposed concrete building model is a Concrete Frame structure supported by typical footing foundations with a concrete slab on grade. The typical floor and roof structures are suspended slabs supported on concrete columns and beams.

The envelope of the structure is assumed to be 70% glazing with window wall system and 30% wall cladding. The interior construction is drywall partitions; and concrete shear walls with header beams to elevator shaft and stair core.

Mechanical and electrical works are included. HVAC system includes electric baseboard heating and ventilation only. Air conditioning is not included.

The level of finishes used as the base for this report is mid-range. This is consistently applied across each building design

### Wood Building

The proposed wood building model is a mass timber structure supported by typical footing foundations with a concrete slab on grade. The typical floor and roof structures are structural wood decking with non structural concrete topping.

The structural walls/columns combinations differ depending on each option, specifically:

1. Mass Timber Core Walls and Glulam Beams & Columns
2. Mass Timber Core Walls and Demising walls with Glulam Beams & Columns
3. Mass Timber Core Walls and External Wall Panels
4. Mass Timber Core Walls, Demising Walls and External Wall Panels ( not in costing)

As noted previous, the architects and engineers details show that structural steel is also used in the FFTT buildings. The use is consistent around the core wall areas for each mass timber option with perimeter stud beams for options 3 and 4.

Mechanical and electrical works are included. HVAC system includes electric baseboard heating and ventilation only. Air conditioning is NOT included.

The level of finishes used as the base for this report is mid-range. This is also consistently applied across each building design

### Areas

The gross floor area of the project measured in accordance with the guidelines established by the Canadian Institute of Quantity Surveyors is:

#### Option 1

Location	Gross Floor Area	No. of Units
Ground Floor	5,160 sqft	0
Typical Floors 2-12	56,760 sqft	66
<b>Total Gross Floor Area</b>	<b>61,920 sqft</b>	<b>66</b>

#### Option 2 and 3

Location	Gross Floor Area	No. of Units
Ground Floor	5,160 sqft	0
Typical Floors 20	98,040 sqft	114
<b>Total Gross Floor Area</b>	<b>103,200 sqft</b>	<b>114</b>

## **Exclusions**

The construction estimate includes all direct and indirect project costs identified in the drawings and other information provided by the Prime Consultant. The estimate specifically excludes the following:

- › Land costs
- › Legal fees and expenses
- › Demolition and Removal of hazardous materials
- › Loose furnishings and equipment
- › Unforeseen ground conditions and associated extras
- › Off-site works
- › Phasing of the works and accelerated schedule
- › Erratic market conditions, such as lack of bidders, proprietary specifications
- › Cost escalation

## **Taxes**

The estimate excludes the Harmonized Sales Tax (H.S.T.).

## **Project Schedule and Escalation**

We have priced this estimate in today's dollars (2011 dollars) and have taken into account current market conditions and quarter competitiveness returning to the marketplace.

## **Pricing**

The estimate has been priced at current rates taking into account the size, location and nature of the project. The unit rates utilized are considered competitive for a project of this type, bid under a stipulated lump-sum form of tender in an open market, with a minimum of five bids, supported by the requisite number of sub-contractors.

The estimate allows for labour, material, equipment and other input costs at current rates and levels of productivity. It does not take into account extraordinary market conditions, where there may be few bidders as well as bidders who may include disproportionate contingencies and profit margins in their tenders.

### 3.13 Schedule Analysis

As part of our study, we completed a review of the entire project schedule as well as the construction schedules for each building option.

#### Pre-Construction Schedule

The main design consultants for this study noted that while there may be a slightly longer design period required for these initial FTT building projects, they also anticipated no additional design time required for this type of building in the future. Accordingly, we did not include any change in pre-construction schedule for the different types of construction options.

#### Construction Schedule

BTY Group met with representatives of some of Canada's largest construction companies to discuss schedule implications for the various designs. We also interviewed specialist timber installers to identify logistics and scheduling challenges.

One of the salient observations was that no company had any experience in undertaking Mass Timber building on this scale. This led them to err on the side of caution in estimating timing and schedules.

It was evident, however, that the FTT building will enjoy a distinct advantage over concrete from the start of the construction of any of the building options. Specifically, once a floor in a FTT building has been completed, it will be available for rough in immediately. On the other hand, Concrete Frame buildings require back propping under each newly poured floor for approximately five to six weeks after the pour. The other delay inherent in Concrete Frame building is related to core construction. This was estimated to delay the start of the project by approximately three to four weeks. FTT construction of the core had no significant delay in floor installation.

As a project progresses, industry experts agreed that the Concrete Frame building would hit a target schedule of constructing a floor in approximately four to five days. The FTT design was estimated to have a similar construction time for each floor. It was also noted that the FTT design would speed the rough-in of carpentry and mechanical and electrical fixtures since no concrete drilling would be required and simple screw fixtures would suffice.

One of the main concerns that held back the FTT construction on a floor-by-floor basis was the requirement to install a double layer of wallboard to the underside of each floor slab (for the encapsulation method). This would delay the Mechanical and Electrical rough-in, and add a risk of the wallboard suffering from

water penetration since the building would not be watertight at the start of installation, especially on the lower floors.

Overall, we estimated the time-savings on the FTT options as follows:

- › Option 1 (12 Storey): 10 Weeks
- › Option 2 & 3 (20 Storey): 10 Weeks

Our Project Cost Summaries show that these schedule savings translate into cost savings both during construction (in the Contractors General Requirements and Fees), and in overall project financing.

#### Financing

The reduction in construction schedule translates into cost savings at the end of the project in the amount of interest to be paid on the project loan. Earlier completion enables earlier sales, which enable earlier loan repayment in full, saving larger interest payments.

#### Industry Expectation

Within the industry, we found a reasonable expectation that as the design development of FTT building advances, there will be significant improvement in savings to be realized for this type of construction. The gains will come primarily from offsite prefabrication of sections, the use of larger panels, and from faster installation as companies develop systems that improve panel placement and securing. Even so, we cannot yet predict precisely how much savings could be achieved through scheduling.

Construction time for Mass Timber buildings is well known in Europe because this type of construction has been systematized there. In Canada, however, it is still in its infancy. There are only a few manufacturers and installers in this sector. High initial start up costs for manufacturers remain a barrier to entry. So currently there is little competition within the market to drive increased supply or lower installation costs.

There are, however, additional market factors that in the long term will have a significant impact on the overall competitiveness of FTT Construction.



## 3.14 Market Factors

### Energy Costs

As energy costs increase manufacturing costs will rise with them. This will have a significant impact on Concrete Frame construction due to the large number of manufactured components (and their delivery) required, e.g. concrete manufacture, reinforcement, formwork, and onsite finishing. FTTT construction's simplicity and its minimal number of components give it distinct advantages as energy costs rise.

### Labour Costs

FTTT construction stands to benefit in the long term from increasing labour costs and labour scarcity, which significantly affected BC's construction market in 2007-2008. With offsite prefabrication and minimal labour requirements onsite during installation, FTTT construction has much less exposure to labour factors than that of concrete frame and steel frame construction.

### Material Cost

The FTTT system can use different mass timber products to achieve similar results. There will be connection differences and varied technical solutions but the overall concepts will remain the same. Each material be it CLT or LSL or LVL has a different set of performance, cost and environmental benefits.

From a cost point of view it is important that there is ample competition in the material marketplace to see that mass timber solutions are explored by building owners and designers. While central Europe now has many CLT manufacturers in place, North America still has very few. Currently only 3 CLT manufacturers are organized here in Canada. Over time this will increase with demand but the importance of the competitive marketplace will in part determine if these ideas are realized at all. It is the proverbial chicken and egg scenario.

One might argue that this same phenomenon has been seen in our glulam industry where there are relatively few manufacturers in Canada compared to central Europe. In turn the cost competitiveness of glulam material here is significantly less than in Europe as a direct result of competition. Often building owners preconception is that a glulam timber building will be more expensive and therefore less worth exploring.

By developing systems that can use either CLT or LSL in particular we are introducing greater material competition at the outset. LSL is produced in abundance in North America primarily for use as beams in light wood frame construction. There appears to be significant room in the LSL industry to grow and provide large panel material to provide a very cost competitive option with CLT. This will in turn keep the CLT industry in check with the competitive pricing that will see a more likely adoption of these new ideas.

### Insurance

The impact of insurance and valuation of risk for mass timber building structures is difficult to measure without a real prototype design to present to underwriter's for their review and evaluation. Preliminary discussion with insurance providers suggest that of the three types of insurance related to a new building type; Professional Liability Insurance, Builder's Risk (Course of Construction Insurance) and Building Property Insurance, Builder's Risk insurance has the most potential to be elevated compared to concrete structures. Further work is required to fully document analysis and testing of systems to demonstrate the physical properties and performance of Mass Timber structures. This is an important step for tall wood structures to reach the competitive market.

### Future Taxes and Insurance

As governments worldwide increasingly impose carbon taxes and levy fees based on environmental impacts of products, FTTT construction will enjoy a distinct and growing advantage. As a renewable resource material - and one that sequesters carbon during its lifetime - FTTT construction should benefit significantly from it's relatively benign environmental impact.

In summary, FTTT construction appears to be well positioned to improve its cost competitiveness over time.

## **Carbon Tax Impacts in the Future**

Today's carbon tax in BC reflects an approach to the cost of carbon specifically through emissions. Current strategies do not reflect the benefit of carbon sequestration. The cost of both emissions and storage can become important factors in choosing one building material over another in the future. This is a complex issue that we extract two principals from that will effect costs in the future:

### **1. The Rising Cost of Carbon Intensive Materials**

Choices in the construction market have an embedded cost of emissions in most carbon tax structures. In other words choosing energy intensive structural or building materials like steel or concrete will have an embedded BC carbon tax in the energy used for the material's production. This is of course only applied when the material is produced here in BC or if the material is produced in a region of the world that has its own carbon tax. Steel for example is arguably impacted less by the BC carbon tax than concrete because it is produced outside of the province. As other jurisdictions in the world move to applying a cost to carbon as is recommended by the majority of world economists, it is assumed that the cost of high energy materials like concrete and steel will rise accordingly. The implications of the increased material cost will more dramatically separate competing materials based strictly on carbon footprint.

In effect it would be expected that the cost of wood would remain stable while concrete and steel prices would continue to rise with rising energy prices and additional costs for carbon (through taxation or other mechanisms). This assumption will make wood solutions that much more cost competitive than steel or concrete.

### **2. The Cost Benefit of Carbon Sequestration**

The second factor in considering today's BC carbon tax is that it does not consider carbon sequestration. In effect, the choice to build with a wood structure that is storing carbon could become a tax benefit to the owners of the building if there is a mechanism in place. We have not found where this concept has been applied in the world to date but clearly this is important in the overall cost comparison exercise and in the overall carbon tax discussion.

### 3.15 Constructability

The construction methods for an FFTT building will be influenced by the location, size and nature of the construction site in question.

We have devised a construction method that is based on current tilt up methods and is suitable for the proposed site for this project. Developed with great assistance from Dan Sadler and PCL Constructors Westcoast Inc.

One of the key issues involved in FFTT construction will be the availability of an on site tower crane or the opportunity to increase the number of cranes on any FFTT building site. With all panels requiring lifting into place by a crane it will be essential that the main contractor allows for a full-time crane focused on the panel installation until all panels are installed.

Panel size will also be dictated by manufacturers' pressing abilities and by transportation limitations. Another factor that requires further analysis is the availability of adequate access routes from storage to site to ensure the delivery of proposed panel sizes. This will be especially important in city centre sites.

One of the prime advantages of FFTT construction is the extensive design completed off site. This helps minimize site errors and reduces the amount of site management required. The use of mass timber panels also reduces the number of trades on site at any one time compared to Concrete Frame construction. Contractors can accordingly reduce the number of trade supervisors and increase cost savings.

A major concern of FFTT construction that needs to be addressed is the effect of extended exposure to water on the panels. There are a number of temporary coating products currently available that can be applied to the panels during construction to help waterproof them without affecting the finishing in the long term. There is also a reasonable expectation that FFTT construction systems and waterproofing methods during construction will advance as the industry matures.

While we have already analyzed the speed of construction in the Schedule Review, it bears repeating that the construction industry expects to see major advances in the speed of construction of FFTT buildings as product selection increases and new installation methods are developed and deployed.

### FFTT Assembly

#### Tall Wood Case Study Assembly Diagram: 20 Storey

The following diagrams illustrate a sequencing plan for the construction of the Tall Wood Case Study 20 storey tower option. This concept explores the possibility of using mass timber panels in their large sizes, up to 64' feet long and 8' feet wide for LVL and LSL, and up to 42' long and 9' wide for CLT. The approach utilizes typical tilt-up technology along with a tower crane that can also be used for foundation, envelope and the like. The basic premise is to work from the inside out, installing the core walls first and working to the exterior walls.

The preferred location of the crane tower would be outside of the building footprint but close to the building's edge. The crane can be configured to be free-standing and sized appropriately for the height and weight requirements of the structure.

Building sites will vary and the room to maneuver with large panels may prove difficult, particularly in urban sites. Additional space is required for the bracing of the panels, principally where panels are required to be braced on the exterior. Accordingly, for sites that are particularly limited in area, panels could be reduced in size to suit the space restrictions.

Furthermore, typical tilt-up braces used for concrete applications may have to be modified in order to make them suitable for the wood panels. Additional considerations include equipment or lifts that would be required to access connection points, material storage and weather protection.

These findings are preliminary in nature and it is recommended that further investigation with engineering and construction plans is required to verify the methodology.

**Construction Diagrams**

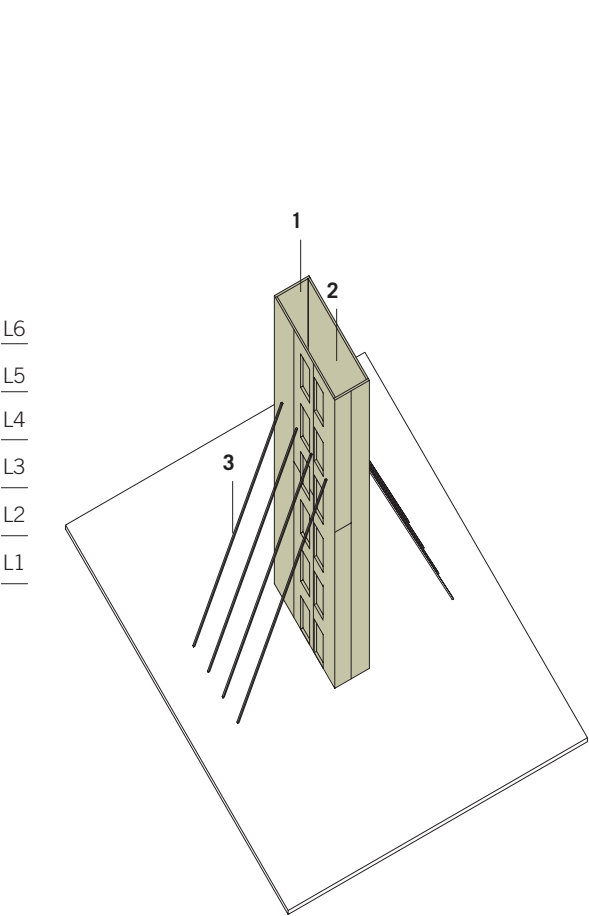

- 1 Install inner core walls. First lift.
- 2 Scaffold inner core to access connections. (TYP.)  
Can also be used to install elevator rails
- 3 Brace inner core walls until core walls are secure.

**STEP 1**

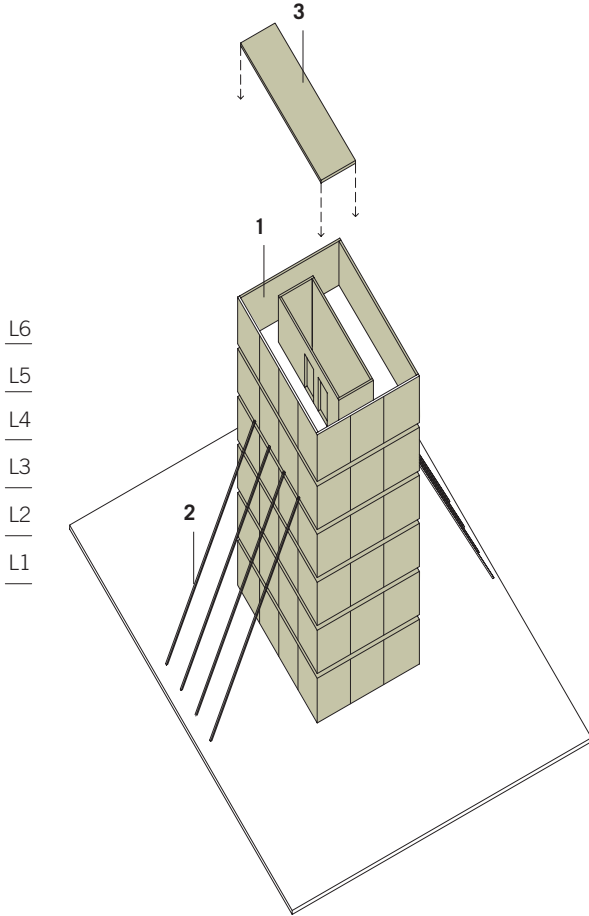

- 1 Install outer core walls and brace
- 2 Brace outer core walls until floors are in
- 3 Install floors and remove braces

**STEP 2**

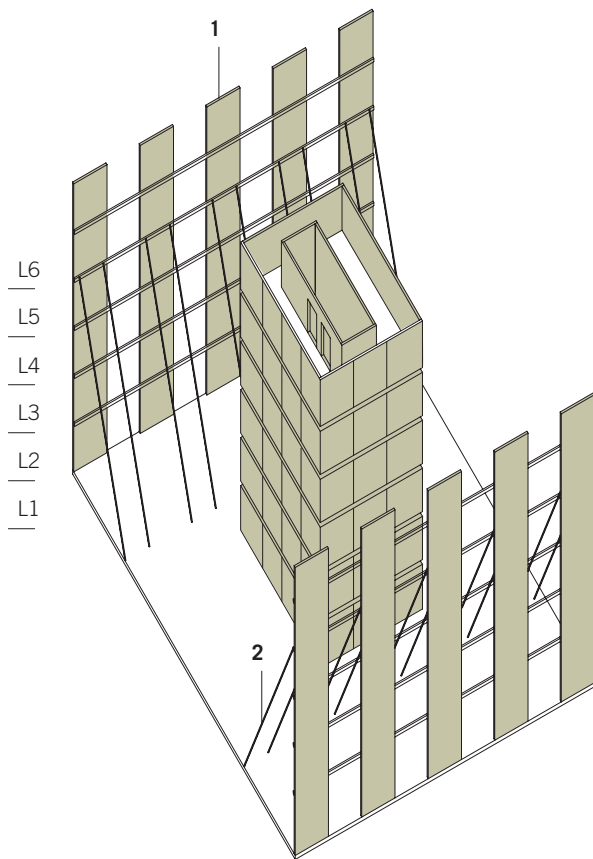

- 1 Low lift exterior walls
- 2 Brace exterior walls

**STEP 3**

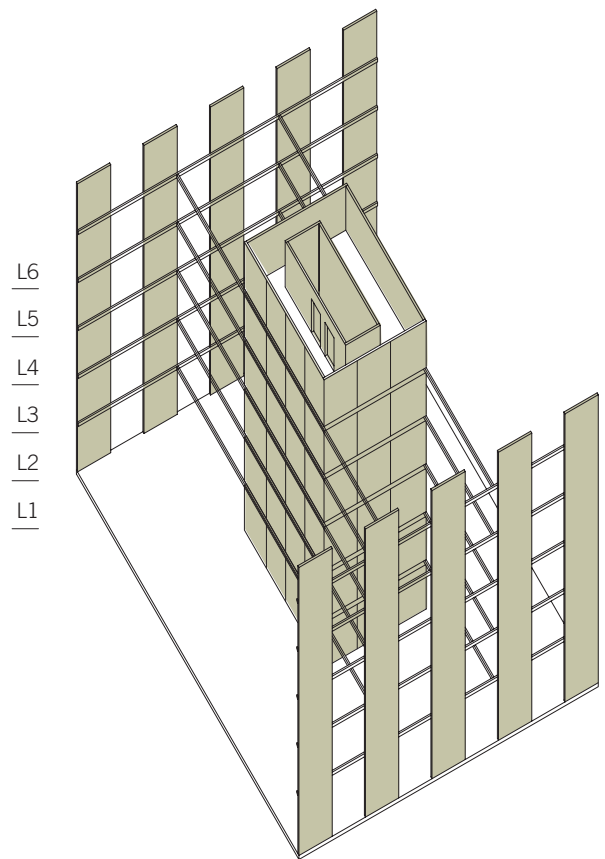

- 1 Install steel beams connecting core to outer walls
- 2 Remove braces

**STEP 4**

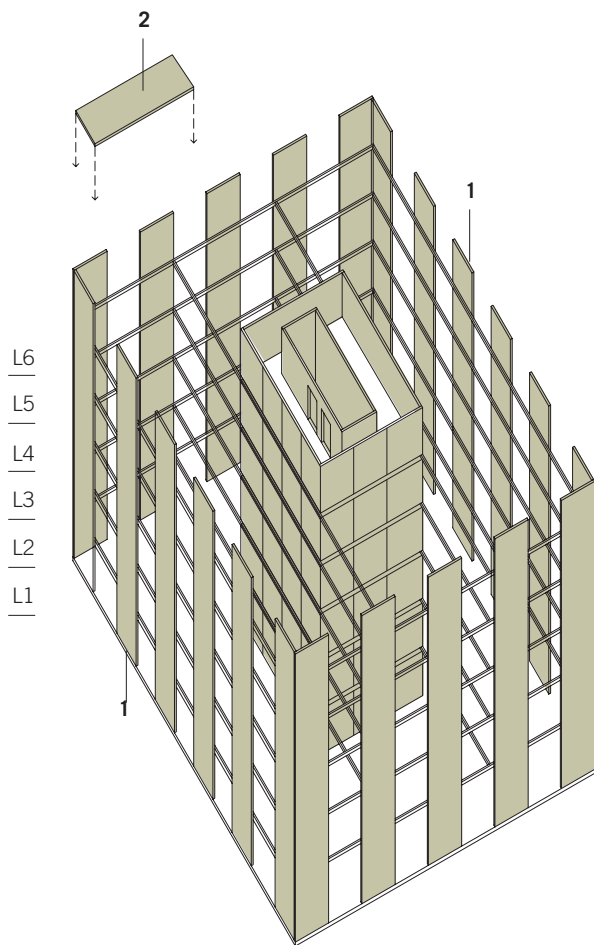

- 1 Low lift remaining two side exterior walls
- 2 Install floors
- 3 Brace until all four exterior walls are connected and floors are in

**STEP 5**

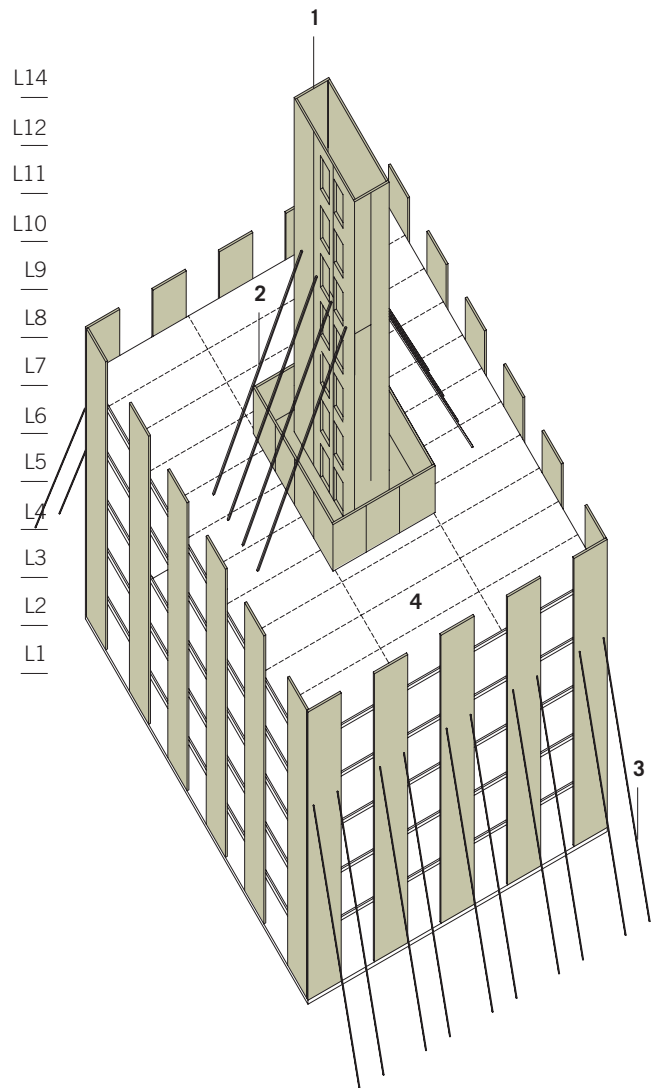

- 1 Second lift inner core
- 2 Brace inner core until all inner core walls are secure
- 3 Brace outer walls
- 4 Will require lift on floor 6 to access connections

**STEP 6**

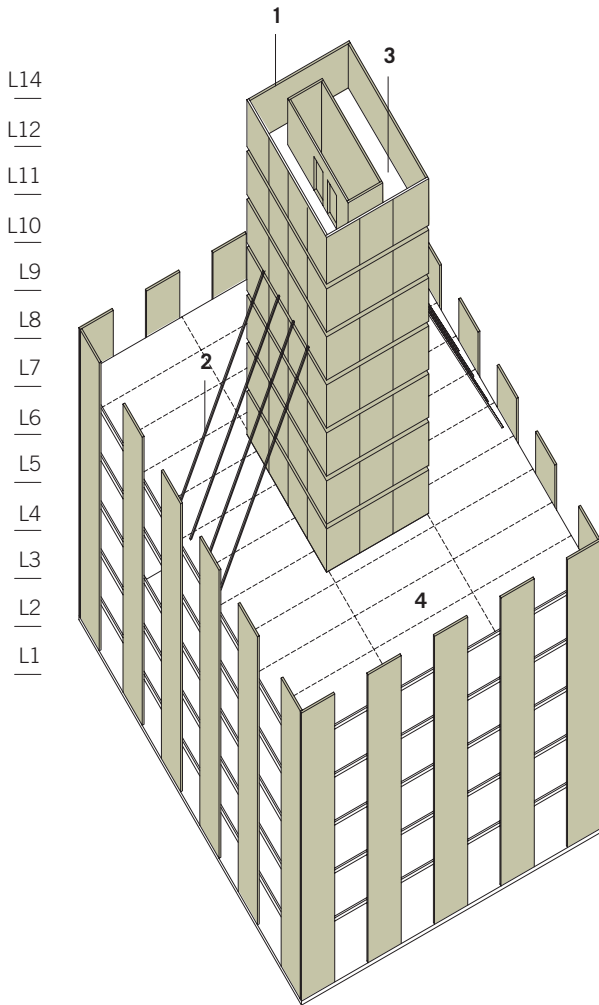

- 1 Second lift outer core walls and floors
- 2 Brace outer core
- 3 Install core floors
- 4 Will require lift on floor 6 to access connections

**STEP 7**

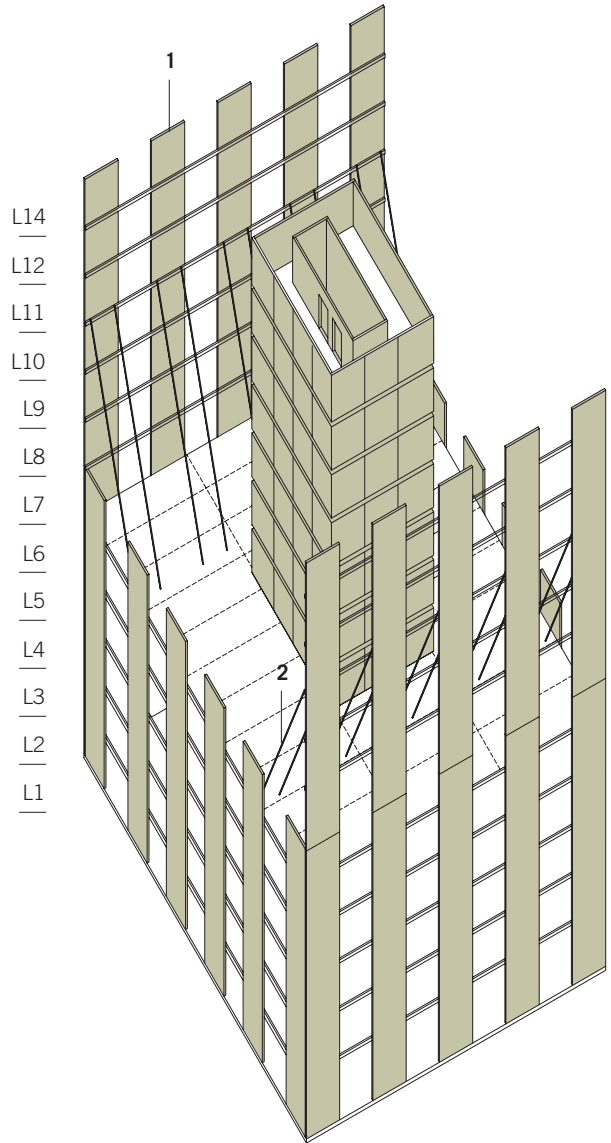

- 1 Second lift outer walls
- 2 Brace walls
- 3 Repeat steps 4,5,6

**STEP 8**

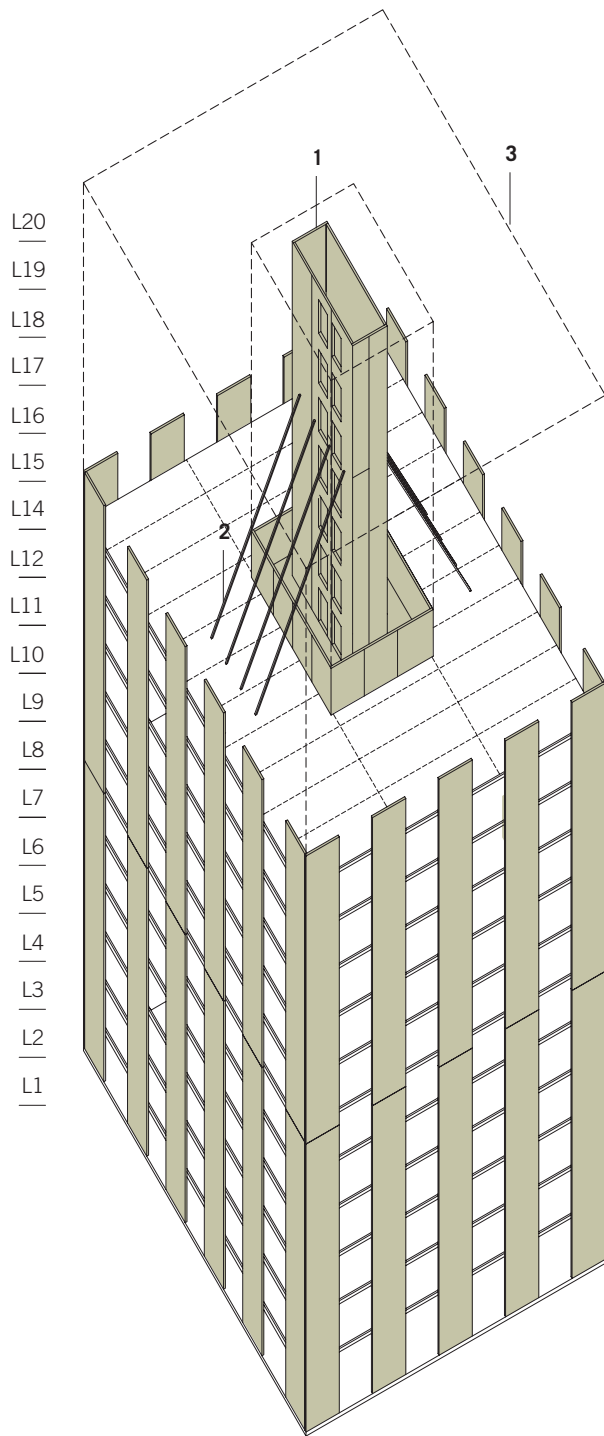

- 1 Install inner core walls. Third lift.
- 2 Brace walls
- 3 Repeat steps 2,3,4,5

**STEP 9**





**INDUSTRY REVIEWS**  
**PART 4**





**INDUSTRY INTERVIEWS**  
**PERSPECTIVES ON WHERE WE ARE HEADED**  
**PART 4**

## 4.1 Industry Representatives

A large number of organizations and individuals contributed to this study with insight specific to their specialty within the building regulation, construction, development and real estate industries. A large thank you is extended to all who participated. While their input is generally reflected throughout the study, a summary of interviews is captured in the following paragraphs for specific reference. Comments reflect the context of the specific discussions, and are not meant to infer support of the study or its contents.

### Contractors

#### **PCL Construction: Attendees**

---

Dan Sadler Senior Project Manager

#### **Comments:**

- › The typical construction schedule for concrete is one week/ floor. A wood system would have to be faster than that to have a significant advantage. Floor to floor height is a critical element in managing cost – should be carefully considered w/ the service space in the ceilings proposed.
- › A number of construction sequences were discussed with a tilt up approach to assembly and a number of different approaches to construction craning. The final sequence proposed has been diagrammed within the document (section 3.15).
- › Who would build the first one? This is a question of risk management and is tied to many of the discussions had with others.

#### **Ledcor Construction: Attendees**

---

Andrew Hull, Manager Business Development

Dave Jamieson Senior Superintendant

Roy Vanbeest Operations Manager

#### **Comments:**

- › Ledcor has explored CLT with BC Housing on two residential towers (12 storey). At that time it was not cost competitive and they did not proceed. Tera Housing may also be a good candidate to build in mass timber.
- › Access to inner city sites and storage on site are extremely limited. Deliveries would have to be staged to avoid storage issues.
- › It is not the traditional timber builders who will understand and install this system it is more akin to concrete. A re-education and re-training of trades would be part of the widespread implementation of the system.
- › There is a loss of efficiency in having to come back again in the construction sequence to clad the building. A more pre-fabricated approach to the complete building assembly would improve its appeal to the developer market.

## Fire Professionals

### City of Richmond Fire Department: Attendees

---

Dave Clou Chief Fire Prevention Officer

#### Comments:

- › Many of the issues that are inherent in the 6 storey wood frame building solutions are resolved by the use of mass timber solutions. These include shrinkage and the inherent mass of the system that offers fire resistance by its nature (ability to char).
- › There are three phases of credibility of the proposal – 1. Design 2. Construction and 3. Long term durability and maintenance. The mass timber solution can be designed without question. The success of the system relies on the consistent execution of details for penetrations and for connections. Long term success requires education of the end user as to the role of the different components of the assembly in protecting the structure from fire and a strategy for replacement of components in the event of fire or severe water damage. This led to a discussion of the fire protection being a “sacrificial layer” that could be replaced relatively easily – whether that be a gypsum based membrane or an additional layer of wood easily removed from the base wood structure.
- › One of the largest risks in multi-unit residential buildings is the exterior balcony and exposure from barbeque’s and fuel fired appliances (such as patio heaters). Without fire detection or sprinkler coverage, flame can burn undetected and spread up and across the face of the building doing significant damage before any control measures can be implemented. Providing sprinkler coverage for these areas would go a long way in eliminating this fire risk.
- › Emergency response was discussed in light of recent earthquake events in Japan. Loss of water supply is a major issue and concern. The downtown core of Vancouver currently has a salt water system piped separately from the main system to provide redundancy in an emergency of this nature. LDMG is currently proposing a gridded dual riser sprinkler system that would still provide water if one of the risers was damaged. Other cities (such as Los Angeles) require that buildings have their own water source, such as tanks or pools on the roof for such an event.

## Code Authorities

### Province of BC Building + Safety Standards Branch: Attendees

---

Bob Thompson Senior Codes Administrator | BCAB Secretary

Tracey Green Liason Manager

Steven Kuan Seismic Engineer

Roger Lam Manager

Jeff Vasey Executive Director

### Comments:

- › Building Code stumbling blocks to tall wood buildings; Currently 6 storeys is allowed for residential construction and for other occupancies using combustible construction. Also, building area is limited for combustible construction, not just building height. The main argument against taller wood structures (combustible construction) would be the lack of scientific data in regards to fire performance. Currently, the fire performance of taller wood structures is not known/accepted by authorities having jurisdiction even through manufacturer's may have done their own testing. For these new engineered wood systems, further testing for fire performance would be required. Options for further testing include computer modeling and prototyping.
- › Market Perception; The current title for "A Case for Tall Wood Buildings" does not give any indication of a new system. The market and public perception is still of platform style framing when associated with wood structures. The Vancouver Sun article was an example that omitted mentioning the structural difference between what is proposed and what is in the public perception. The report should include some material on mass timber vs. stick frame to clarify the difference.
- › Charring; The main concern of the "charring" method would be the contribution of the material to the smoke and heat developed by a fire. The areas of particular concern for smoke and heat spread would be the corridors and exits which are treated more conservatively in the code as the primary way of getting out of a building in the event of a fire.
- › Fire retardants; more development is needed to fully understand. Deterioration over time. Off gassing, environmental health.
- › Structure; Clarify the structural differences between concrete and wood structures. May work numerically but for acceptance would require further testing, prototypes etc. Clarify "weak beam, strong column" and the interaction with the core. Connection details are critical to the structure – for example what is the connection detail at the ground?

## City of Vancouver: Attendees

---

William Johnston Chief Building Official

James Hook Project Coordinator

Patrick Ryan Deputy Chief Building Official

Rick Cheung Building Code Specialist

James Lau Building Policy Engineer

## Comments:

- › Separating this study from the 6 storey discussion is important.
- › Key issues include long term maintenance, durability and perceived envelope issues with wood construction.
- › Current discussions with regard to the building code are considering eliminating the combustible | non-combustible designations. How do European model codes compare? This should be discussed in the study.
- › What is the embodied energy of this type of building over its lifespan? How would this compare to concrete and steel?
- › Tax structures around carbon tax related to embodied energy would change the way that developers think about building with this kind of system.
- › The proposal to encapsulate in a gypsum membrane is reducing the sustainability argument for this construction type. A charring approach would support this argument more effectively, but would have to be extensively tested including all proposed connections. A system would need to be developed to rate the connections - heavy timber connections developed in Europe conceal connectors in the wood.
- › How does this system impact design freedom? Could the floor plates step back, be curved, etc...
- › Insuring the building - the largest fire risk is during construction.
- › Termites are an issue that would be a problem in other climates.
- › Could CLT be made out of salvaged wood?
- › Could existing buildings be retrofitted with engineered products?
- › Increased seismic protection of the sprinkler system was discussed in light of recent earthquake events in Japan. A looped system (vertical) is proposed rather than separate risers – similar to what was designed for the new Vancouver Convention Centre.
- › The risk from plumbing leaks and overflows needs to be addressed. How is the system retrofitted or repaired?
- › Scissor stairs – are currently not permitted in 6 storey wood construction due to shrinkage issues and potential breach of the fire protection membrane– given that shrinkage in a mass timber solution is minimal (comparable to concrete) this would have to be reviewed on a detail basis along with the attachment of the elevator carriage to the inner walls of the core structure.



## Developers

### Westbank Projects Corporation Attendees:

---

Ian Gillespie Developer | Owner

### Comments:

- › Resale Value; Office towers made of concrete will have a higher retail value than a steel building (from experience). Concrete is considered to be more comfortable to be in, for reasons of acoustics, vibrations etc. Office buildings are rated based on class. Construction type would play a role in the evaluation of class.
- › Can a wood core be sufficient for an elevator?
- › There is a perception that concrete buildings last longer than wood buildings.
- › The best way to gain acceptance is through building. The first one will be difficult, but the system will gain momentum shortly afterwards, after 10 it may become commonplace?
- › Where would an all wood structure be in terms of LEED rating?
- › Telus is marketed as a LEED Platinum building. Therefore, it is anticipated to have better marketability in the future, if it were to be sold later on. For residential buildings, environmental ratings have less marketability as consumers are less willing to spend a few extra hundred dollars on a mortgage for a LEED rating.
- › Residential market in Vancouver. 70% of our purchasers are from overseas (China) and would have more difficulty accepting a wood structure building. However, there is a market for instance in such areas as SFU and UBC.
- › These wood structures should be sold at the high-end of the market. Marketing it as a stronger or equal to concrete might be the way to go.
- › Perhaps the starting place for one of these structures is the public sector.
- › Developers have a high margin of risk and a low profit margin. The first might be equal or greater in cost to concrete.
- › The warmth of wood is appealing.

## Marketing Consultants | Consumer Opinion

### MAC Marketing: Attendees

---

Cameron McNeill

#### Comments:

- › The fact that mass timber building is a new typology lends itself to getting a start in the public sector – public housing or institutionally driven development such as SFU or UBC. The private market would start to build with this building type most likely only after it was established, with some example structures built.
- › The public perception of wood is that it is cheaper than concrete and steel construction. If the mass timber typology is to gain widespread acceptance in the private sector it must be developed for and marketed to a high end clientele as being equal to or stronger than concrete.
- › The ultimate selling point is cost. The system must be competitive with concrete to be marketable. The Vancouver market is largely Asian and overcoming the perceived value of concrete buildings will be a significant challenge.
- › Some characteristics that should be developed to target consumers include – the beauty of wood, the innovation of the system and safety around fire protection and earthquake.





**NEXT STEPS**  
PART 5



# **NEXT STEPS**

## **PART 5**

## 5.1 Recommended Studies

As part of the continuing research and development phase of the mass timber building design, it is recommended that the following further studies, physical testing, and research/dialogue initiatives be considered to facilitate the project success in the future which we hope will lead to the construction of the first timber high-rise in Canada.

### Peer Review

---

- › The analysis carried out as part of this study is preliminary and aimed at establishing the feasibility of our concepts. More detailed analysis testing and peer review are required to satisfy the requirements of due diligence. In order to broaden the appeal of this future study, we would recommend that formal peer reviews be carried out both by Canadian and US experts.

### Public Campaign and Education

---

- › A public campaign to “reintroduce wood” and specifically the unique benefits of mass timber to the general public. This is very important to overcome the preconceptions that exist and in educating people on why these ideas are important from an environmental, economic and global perspective.
- › Unless consumers understand the big picture of why mid-rise and tall wood buildings are being explored, how safe they are and how they benefit society, it is unlikely that these ideas will take hold.
- › It is also important to continue the BC Woodworks and Canada Wood Council's structure for encouraging architecture and engineering professionals' understanding and expertise in new approaches to large, medium and tall wood buildings.

### Structural Analysis

---

- › Advanced dynamic and non-linear analysis of the proposed lateral load resisting systems
- › Detailed analysis of typical connection options
- › More detailed construction and erection engineering, in conjunction with industry experts
- › Detailed cost analysis in conjunction with cost consultants, suppliers and builders

## Structural Testing

---

- › Testing of overall moment frame behaviour, with CLT as well as LSL/LVL panels
- › Testing of typical connections
- › Testing of high and low pressure adhesives for the lamination of LSL and LVL panels

## Code Discussions Research and Testing

---

- › Development of a fire testing program for specified FTTT building systems components including encapsulated and exposed timber panel configurations in horizontal and vertical orientations.
- › Development of detailed fire and smoke modeling of the project design to assist in facilitating/developing the mass timber building design concept further.
- › Fire testing of mass timber panel assemblies including the fire performance of panel connection hardware details.
- › In conjunction with fire modeling activities, a complete “alternative solution” analysis for the mass timber building design concept needs to be prepared, as a continuation of this preliminary conceptual study.
- › Testing of fire stopping assemblies for typical service penetration conditions through mass timber systems (i.e., combustible and non-combustible piping, electrical cables/wiring and similar building services contemplated in mass timber buildings).
- › Development of future Code change proposals for the deletion of “combustible construction” terminology for mass timber systems, such that timber systems will be treated as an equal material to other conventional building construction materials (concrete, steel) that would not be limited in use by building area, height or occupancy.



## Pilot project

---

- › It would be beneficial to incorporate these studies into the design and construction of an actual pilot project, where costs and construction issues could be tested in real life. Ultimately pilot projects at various heights should be explored.
- › The 2008 Stadhaus project in London illustrated how a platform built CLT solution can achieve 9 stories (in a less seismically active area than coastal BC). We would suggest that a pilot project at a greater height of 12-16 might be a logical next step that would show BC's and Canada's leadership in these discussions worldwide. A 20 story option will be arguably more emotionally charged but given the findings of the report and work over time with all stakeholders in these discussions (perhaps most importantly building authorities) we expect to see these scales appear soon somewhere in the world.
- › Several developers spoke to the need for a public role in the initial pilot projects to help manage the issues of first to market costs and risk. Public-private partnerships were suggested as a logical approach that would help introduce tall wood buildings effectively. Post secondary institutions were also mentioned as logical places for introduction in the market folding into the philosophy for leadership and innovation that is prevalent in BC's universities and colleges.
- › Continued Dialogue
  - › Continued meeting and presentation with key stakeholders to identify and develop critical design/construction details.
  - › Meetings with the Authorities Having Jurisdiction to discuss the pilot project directions/details and map-out the way forward for the approvals process including Development Permit issues, strategies for Building Code compliance, Alternative Solution development, etc.
  - › Information sharing and transfer of fire testing data that has been completed to date (by FPInnovations and others) relative to other mass timber systems assemblies in Canada.



ADDENDA: WOOD INNOVATION AND DESIGN CENTRE: A CASE STUDY IN BRITISH COLUMBIA. IMAGE: MICHAEL GREEN ARCHITECTURE

## **Market Potential Review and Research in National and Global Markets**

---

- › Evaluation of insurance implications and costs during and post construction
- › Evaluation of home warranty program implications
- › Evaluation of Carbon Tax and incentives of carbon sequestration
- › Evaluation of energy costs and material selection -  
The embedded cost of energy in mass wood versus concrete or steel
- › Evaluation of maintenance costs and long term durability

## **Wood Design, Material Science and Forestry Discussions and Research**

---

- › Further development of material science – innovations in LSL manufacturing and rapidly renewable approaches to the material
- › Capacity analysis – what is the impact on forestry – economic and environmental – with an increase use of wood

## **Cost Evaluation with Steel Alternatives in National and Global Markets**

---

- › Concrete construction largely dominates tall building construction in Western Canada. In order to expand the ideas of this study and test FFTT's competitiveness in larger markets, it needs to be compared against steel benchmarks.

## **Tall Wood Conference and Strategic Planning for Industry Evolution**

---

- › The ideas of this study and of other Tall Wood studies currently being undertaken around the world need to be presented to a wide audience. Through peer review and collaboration new and more sophisticated solutions will develop. A Tall Wood conference may be a good starting point.
- › Given the scale of opportunity that Mass Timber solutions offer, organizations (government and non-government) need to collaborate to create a strategic plan for change within the forestry, lumber and construction industries.





**REFERENCE DOCUMENTS**  
**PART 6**



# REFERENCE DOCUMENTS

## PART 6





## Appendix A



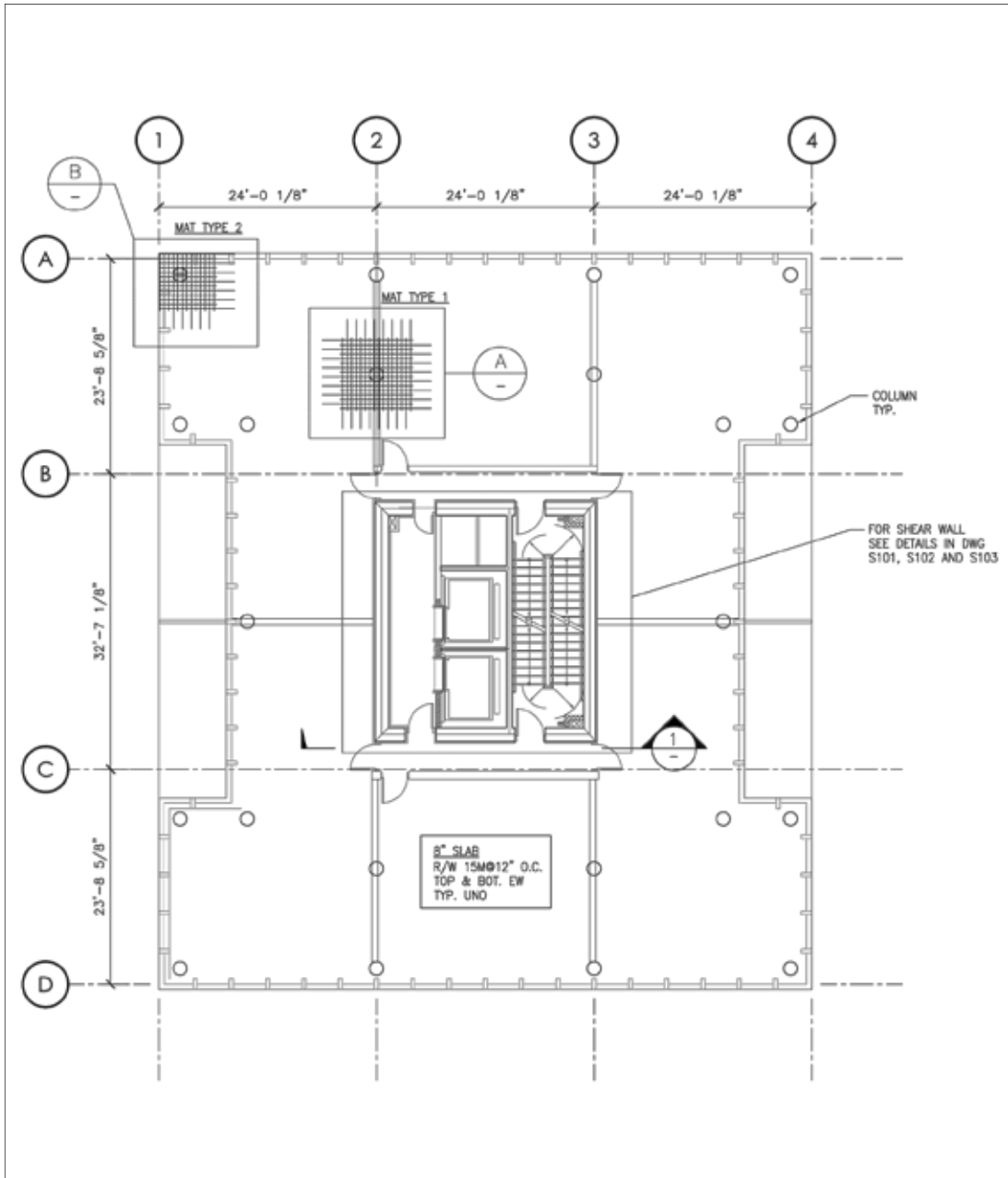

# Appendix A: Concrete Base Building Details

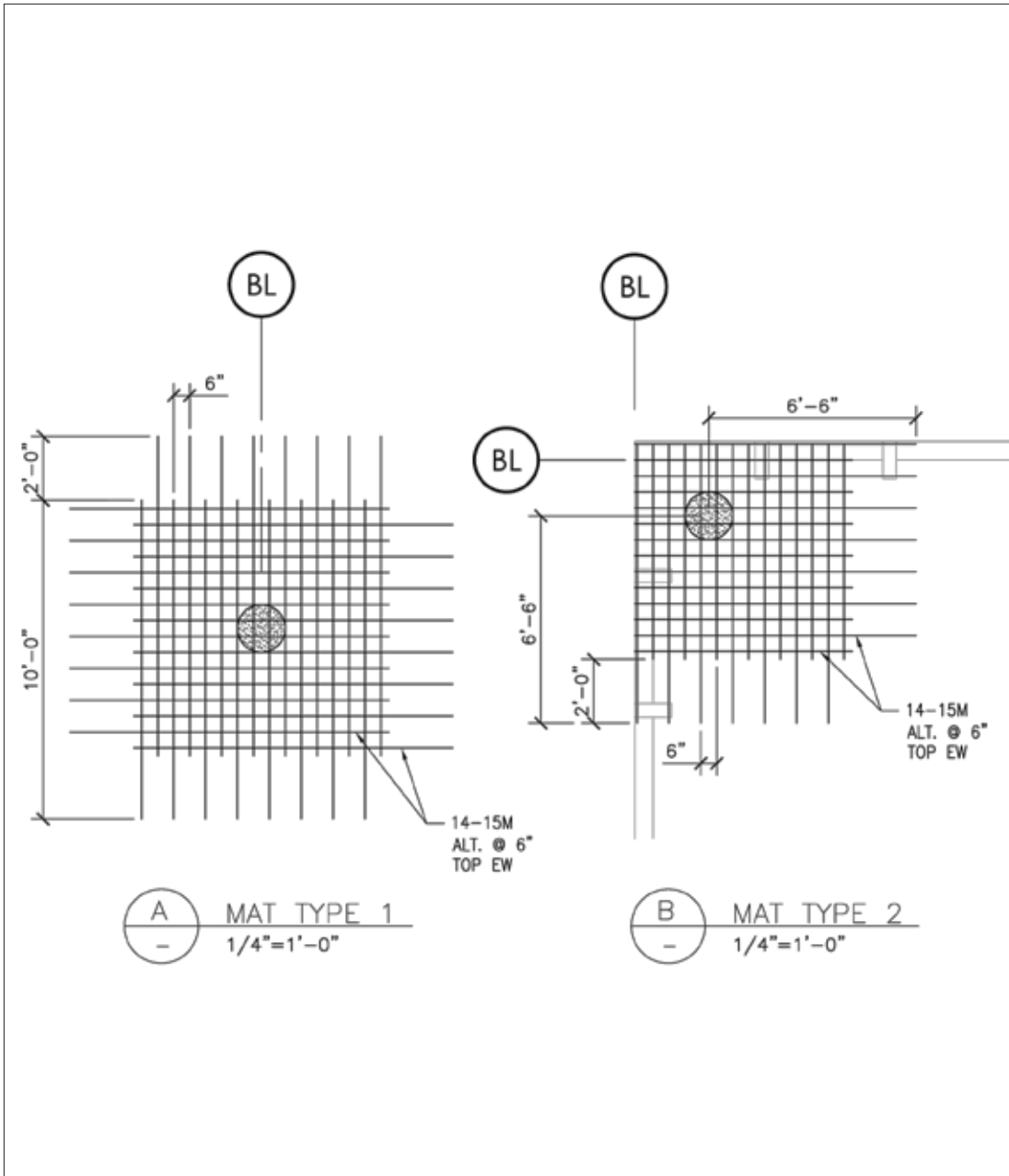

 <b>EQUILIBRIUM</b> CONSULTING INC. CONSULTING STRUCTURAL ENGINEERS 202-388 West 8th Ave. tel: 604 730-1422 Vancouver, B.C. fax: 604 738-8191 V5Y 3X2 info@eqcanada.com	Project: CONCRETE HIGHRISE 12, 20, 30 STOREYS		Project No. 10075	Revisions: 
	Title: KEY PLAN		Date: MAR 09, 2011	SKETCH No. <b>DS-S01</b>
	Drawn: RV	Checked: JEK	Scale: NTS	

RV - I:\2010\10075 12 Storey Wood Blog Study\Drawings\10075 DS-S01.dwg - Wed, 9 Mar 2011 - 11:20



 <b>EQUILIBRIUM</b> CONSULTING INC  CONSULTING STRUCTURAL ENGINEERS 202-388 West 8th Ave. tel: 604 730-1422 Vancouver, B.C. fax: 604 738-8191 V5Y 3X2 info@eqcanada.com	Project: CONCRETE HIGHRISE 12, 20, 30 STOREYS		Project No. 10075	Revisions: 
	Title: MAT TYPE 1 / MAT TYPE 2		Date: MAR 09, 2011	SKETCH No. <b>DS-S02</b>
	Drawn: RV	Checked: JEK	Scale: AS SHOWN	

RV - I:\2010\10075 12 Storey Wood Blog Study\Drawings\10075 DS-S01.dwg - Wed, 9 Mar 2011 - 11:20

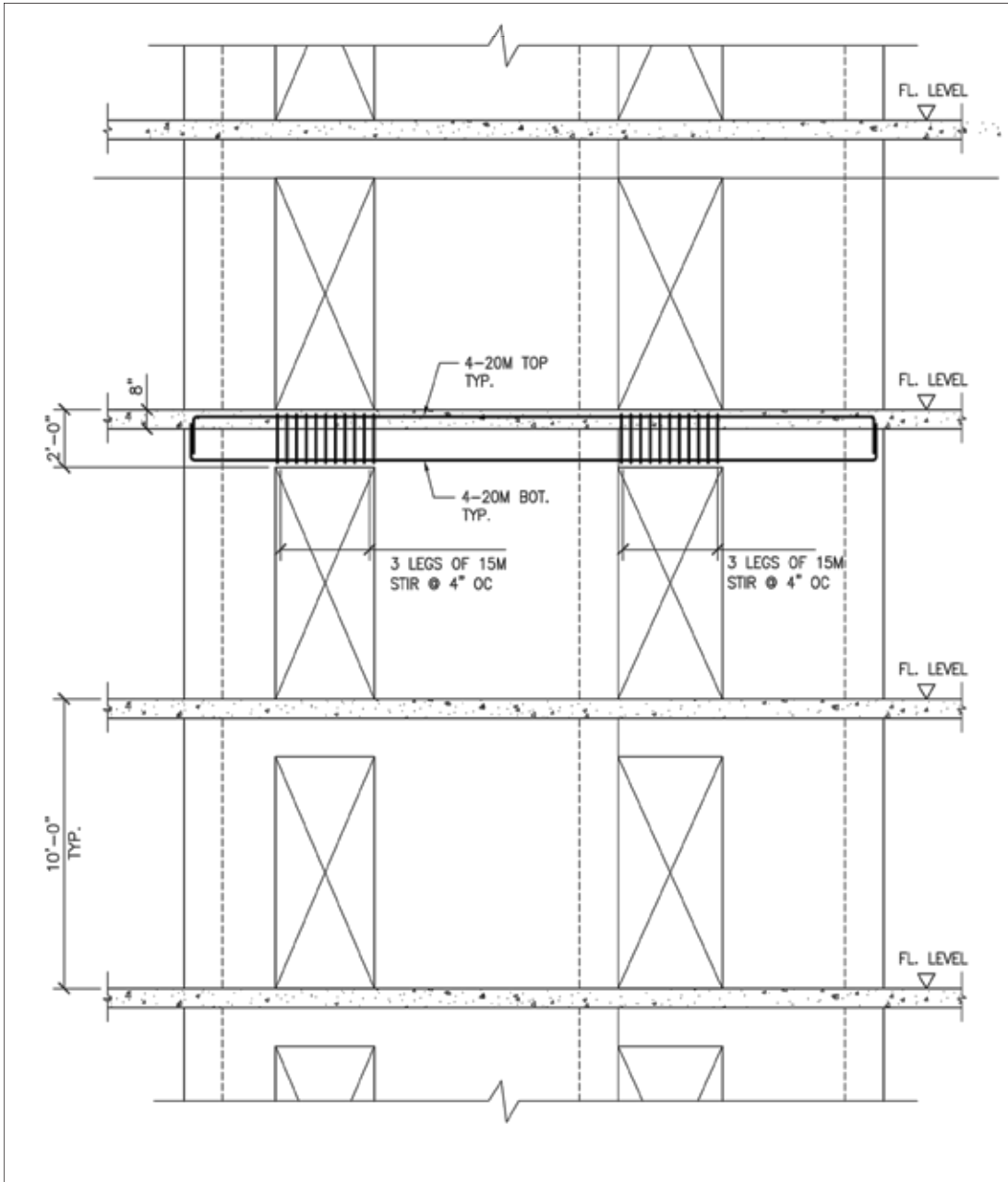

**CONSULTING STRUCTURAL ENGINEERS**

202-388 West 8th Ave. tel: 604 730-1422  
 Vancouver, B.C. fax: 604 738-8191  
 V5Y 3X2 info@eqcanada.com

Project: CONCRETE HIGHRISE 12, 20, 30 STOREYS

Project No.  
10075

Revisions:



Title: SHEAR WALL HEADER BEAM

Date:  
MAR 09, 2011

SKETCH No.

**DS-S03**

Drawn: RV

Checked: JEK

Scale: NTS

RV - I:\2010\10075 12 Storey Wood Blog Study\Drawings\10075 DS-S01.dwg - Wed, 9 Mar 2011 - 11:20

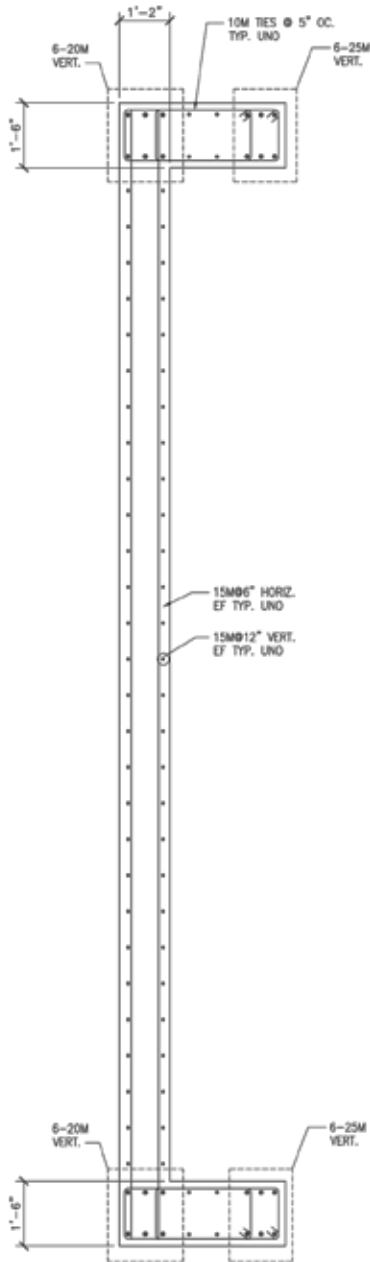

**EQUILIBRIUM**  
CONSULTING INC  
CONSULTING STRUCTURAL ENGINEERS  
202-388 West 8th Ave. tel: 604 730-1422  
Vancouver, B.C. fax: 604 738-8191  
V5Y 3X2 info@eqcanada.com

Project: CONCRETE HIGHRISE 12, 20, 30 STOREYS

Project No.  
10075

Revisions:  
△

Title: SHEAR WALL AT BAYLINE 2  
SHEAR WALL REINFORCING PLAN  
UP TO 12 STOREYS

Date:  
MAR 09, 2011

SKETCH No.  
**DS-S04**

Drawn: RV

Checked: JEK

Scale: NTS

RV - I:\2010\10075 12 Storey Wood Blog Study\Drawings\10075 DS-S01.dwg - Wed, 9 Mar 2011 - 11:19

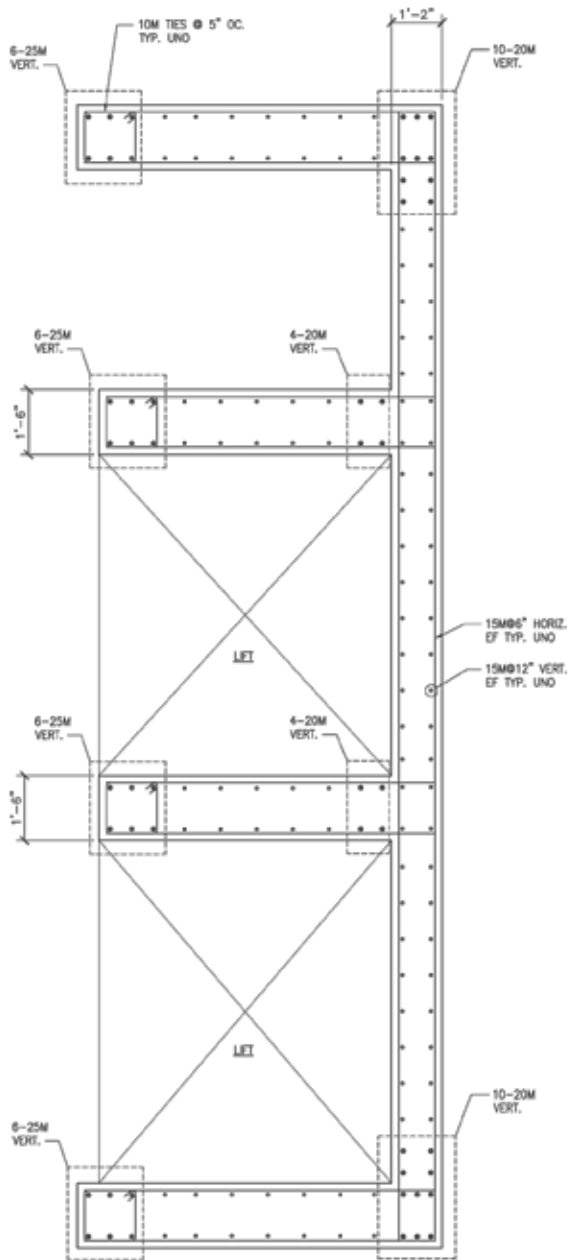

**CONSULTING STRUCTURAL ENGINEERS**  
 202-388 West 8th Ave. tel: 604 730-1422  
 Vancouver, B.C. fax: 604 738-8191  
 V5Y 3X2 info@eqcanada.com

Project: CONCRETE HIGHRISE 12, 20, 30 STOREYS

Project No.  
10075

Revisions:



Title: SHEAR WALL BTW BAYLINE 2 & 3  
 SHEAR WALL REINFORCING PLAN  
 UP TO 12 STOREYS

Date:  
MAR 09, 2011

SKETCH No.



**DS-S05**

Drawn: RV

Checked: JEK

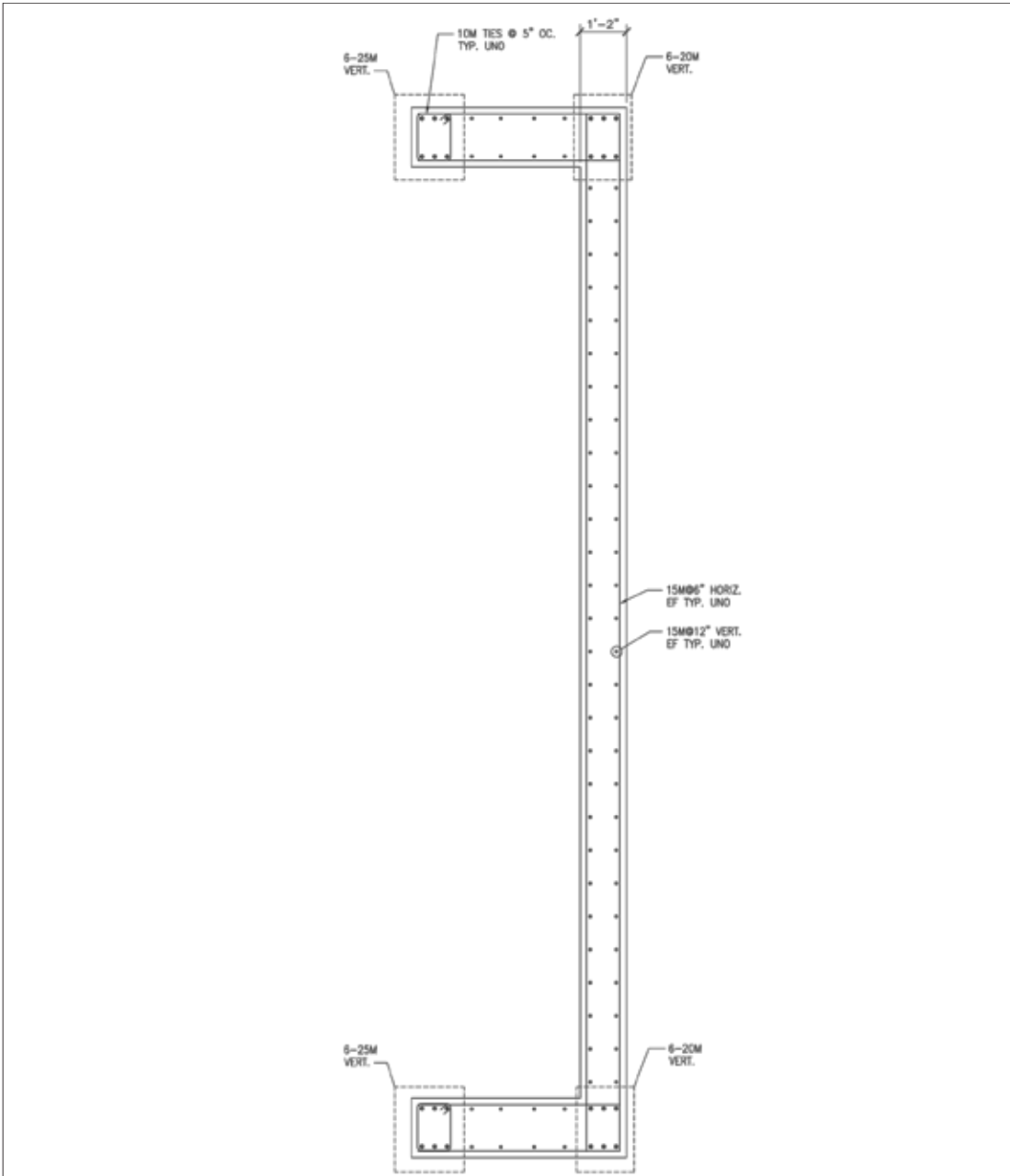
Scale: NTS



 <p><b>EQUILIBRIUM</b> CONSULTING INC</p> <p>CONSULTING STRUCTURAL ENGINEERS 202-388 West 8th Ave. tel: 604 730-1422 Vancouver, B.C. fax: 604 738-8191 V5Y 3X2 info@eqcanada.com</p>	Project: CONCRETE HIGHRISE 12, 20, 30 STOREYS		Project No. 10075	Revisions: 
	Title: SHEAR WALL AT BAYLINE 3 SHEAR WALL REINFORCING PLAN UP TO 12 STOREYS		Date: MAR 09, 2011	SKETCH No. <b>DS-S06</b>
	Drawn: RV	Checked: JEK	Scale: NTS	

RV - I:\2010\10075 12 Storey Wood Blog Study\Drawings\10075 DS-S01.dwg - Wed, 9 Mar 2011 - 11:19

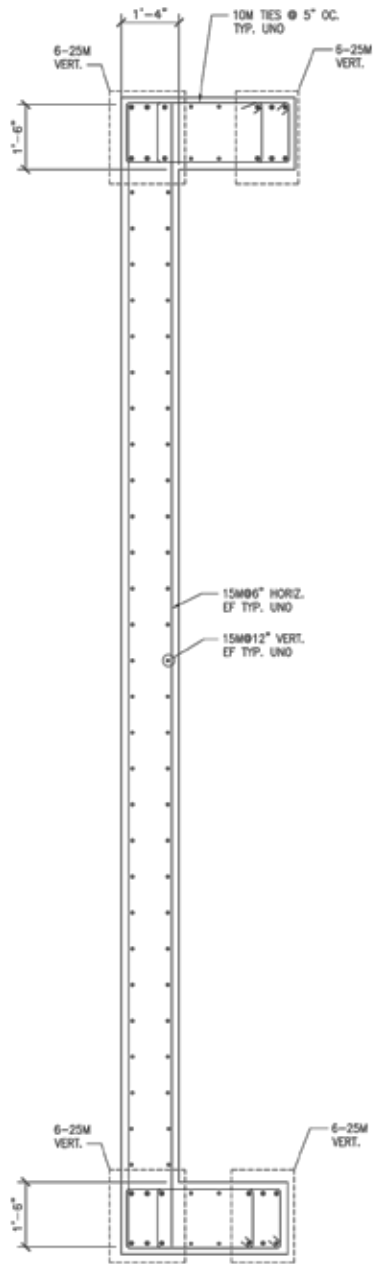

**CONSULTING STRUCTURAL ENGINEERS**  
 202-388 West 8th Ave. tel: 604 730-1422  
 Vancouver, B.C. fax: 604 738-8191  
 V5Y 3X2 info@eqcanada.com

Project: CONCRETE HIGHRISE 12, 20, 30 STOREYS

Project No.  
10075

Revisions:



Title: SHEAR WALL AT BAYLINE 2  
SHEAR WALL REINFORCING PLAN  
UP TO 20 STOREYS

Date:  
MAR 09, 2011

SKETCH No.



**DS-S07**

Drawn: RV

Checked: JEK

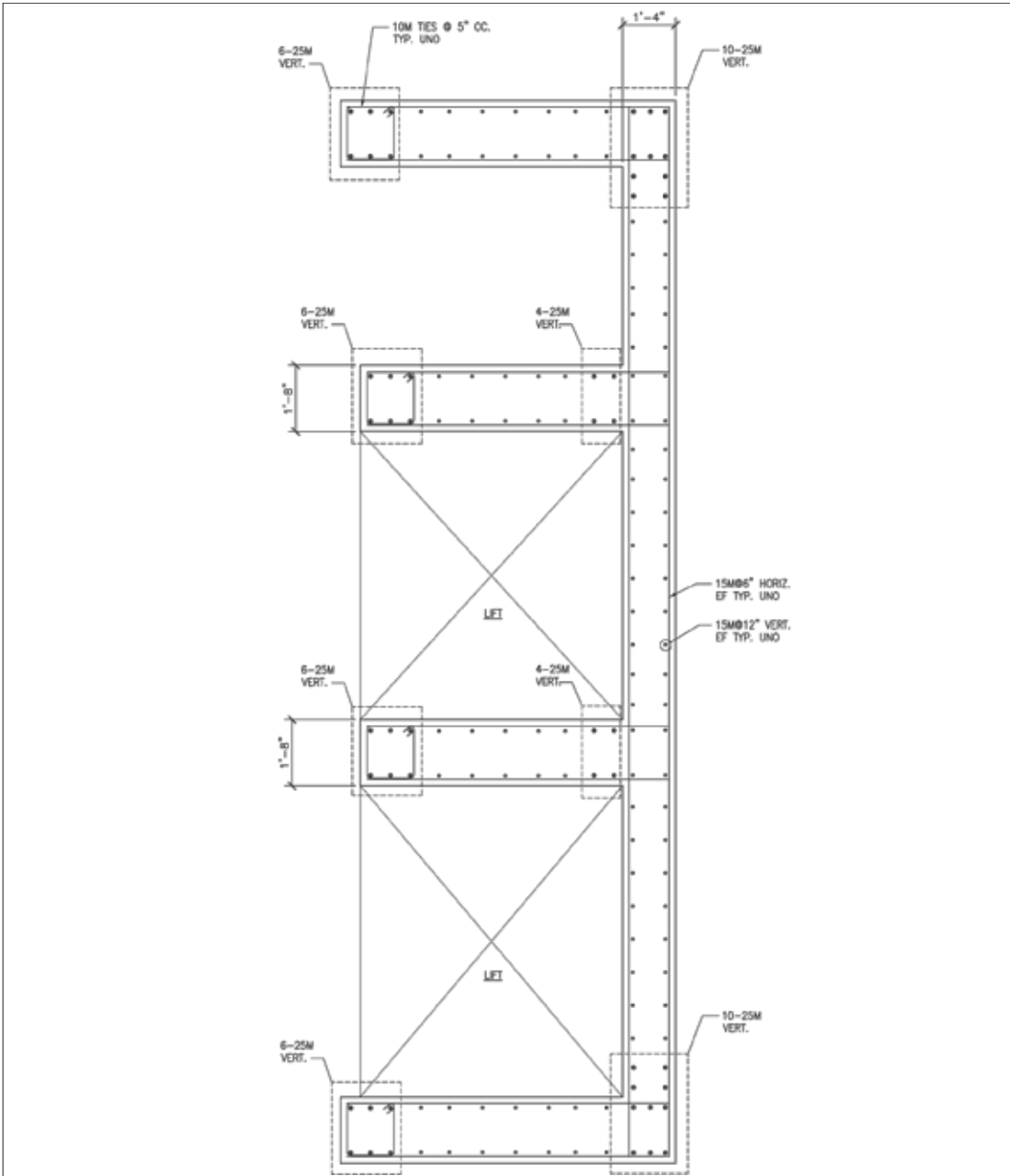
Scale: NTS





 <b>EQUILIBRIUM</b> CONSULTING INC CONSULTING STRUCTURAL ENGINEERS 202-388 West 8th Ave. tel: 604 730-1422 Vancouver, B.C. fax: 604 738-8191 V5Y 3X2 info@eqcanada.com	Project: CONCRETE HIGHRISE 12, 20, 30 STOREYS		Project No. 10075	Revisions: 
	Title: SHEAR WALL BTW BAYLINE 2 & 3 SHEAR WALL REINFORCING PLAN UP TO 20 STOREYS		Date: MAR 09, 2011	SKETCH No. <b>DS-S08</b>
	Drawn: RV	Checked: JEK	Scale: NTS	

RV - I:\2010\10075 12 Storey Wood Blog Study\Drawings\10075 DS-S01.dwg - Wed, 9 Mar 2011 - 11:18

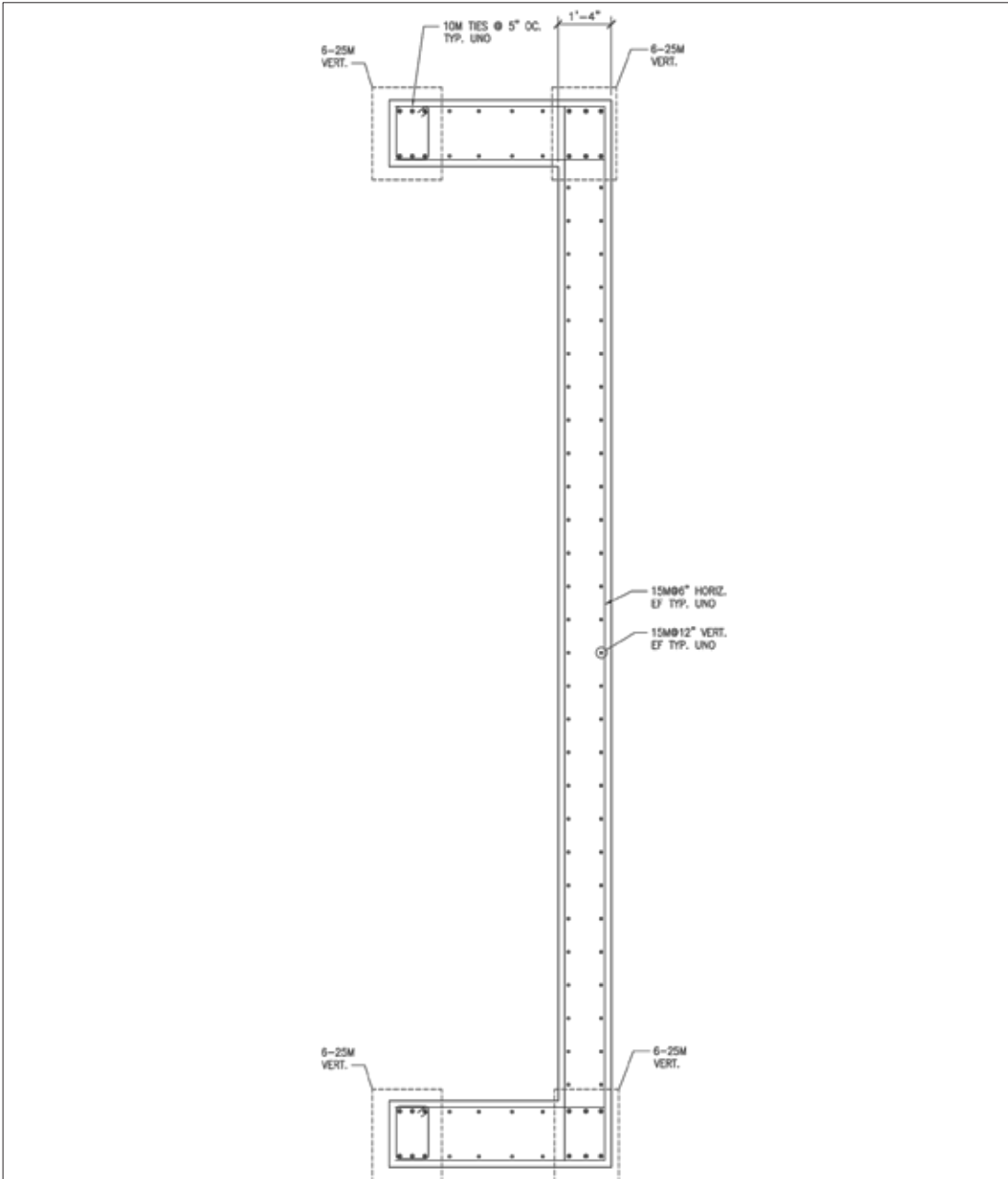





 <b>EQUILIBRIUM</b> CONSULTING INC CONSULTING STRUCTURAL ENGINEERS 202-388 West 8th Ave. tel: 604 730-1422 Vancouver, B.C. fax: 604 738-8191 V5Y 3X2 info@eqcanada.com	Project: CONCRETE HIGHRISE 12, 20, 30 STOREYS		Project No. 10075	Revisions: 
	Title: SHEAR WALL AT BAYLINE 3 SHEAR WALL REINFORCING PLAN UP TO 20 STOREYS		Date: MAR 09, 2011	SKETCH No. <b>DS-S09</b>
	Drawn: RV	Checked: JEK	Scale: NTS	

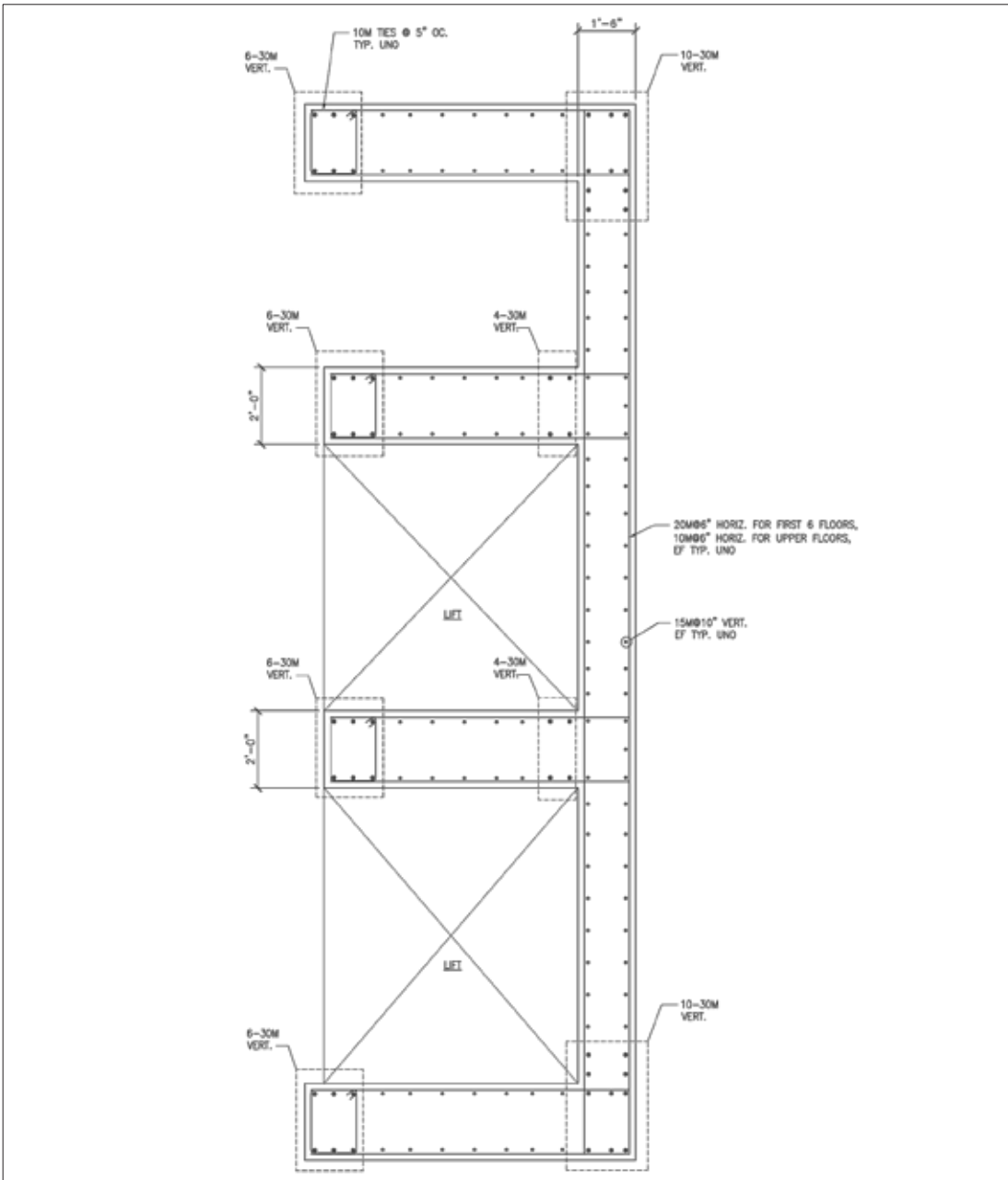

RV - I:\2010\10075 12 Storey Wood Blog Study\Drawings\10075 DS-S01.dwg - Wed, 9 Mar 2011 - 11:18

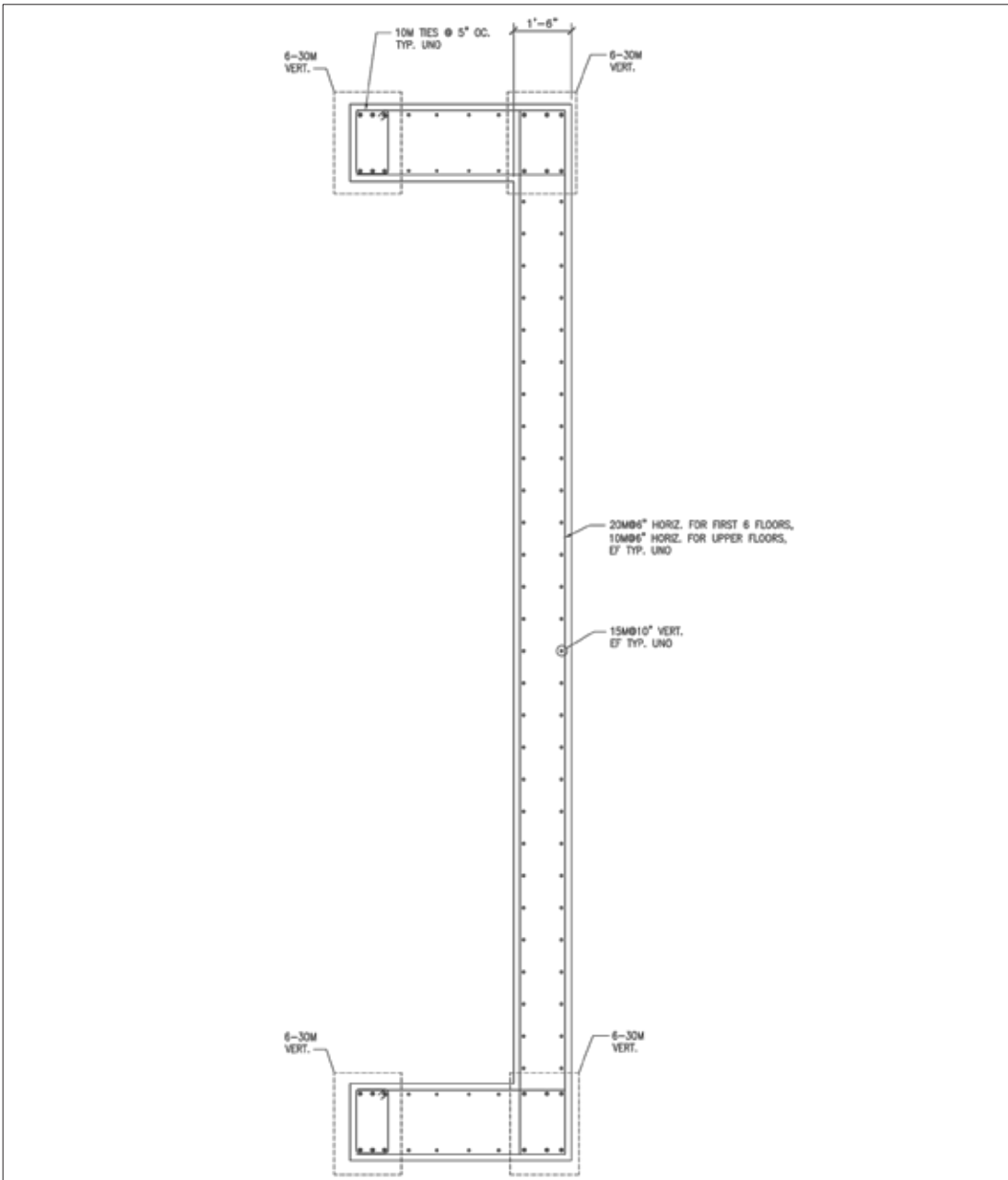

 <p><b>EQUILIBRIUM</b> CONSULTING INC</p> <p>CONSULTING STRUCTURAL ENGINEERS</p> <p>202-388 West 8th Ave. tel: 604 730-1422 Vancouver, B.C. fax: 604 738-8191 V5Y 3X2 info@eqcanada.com</p>	Project: CONCRETE HIGHRISE 12, 20, 30 STOREYS		Project No. 10075	Revisions: 
	Title: SHEAR WALL BTW BAYLINE 2 & 3 SHEAR WALL REINFORCING PLAN UP TO 30 STOREYS		Date: MAR 09, 2011	SKETCH No. <b>DS-S11</b>
	Drawn: RV	Checked: JEK	Scale: NTS	

RV - I:\2010\10075 12 Storey Wood Blog Study\Drawings\10075 DS-S01.dwg - Wed, 9 Mar 2011 - 11:17



 <b>EQUILIBRIUM</b> CONSULTING INC CONSULTING STRUCTURAL ENGINEERS 202-388 West 8th Ave. tel: 604 730-1422 Vancouver, B.C. fax: 604 738-8191 V5Y 3X2 info@eqcanada.com	Project: CONCRETE HIGHRISE 12, 20, 30 STOREYS		Project No. 10075	Revisions: 
	Title: SHEAR WALL AT BAYLINE 3 SHEAR WALL REINFORCING PLAN UP TO 30 STOREYS		Date: MAR 09, 2011	SKETCH No. <b>DS-S12</b>
	Drawn: RV	Checked: JEK	Scale: NTS	

RV - I:\2010\10075 12 Storey Wood Blog Study\Drawings\10075 DS-S01.dwg - Wed, 9 Mar 2011 - 11:16

## Structural Modeling

### Option 1 - 12-Storey with Core

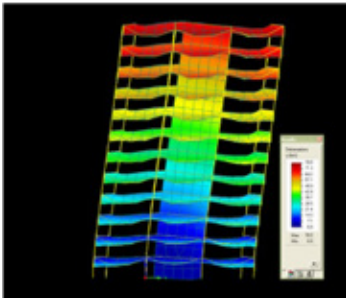
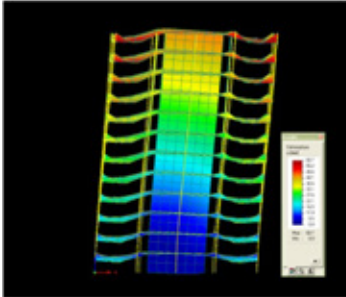

<b>Deflection</b>	<b>Wind X</b>	<b>EQ X</b>	<b>Wind Y</b>	<b>EQ Y</b>
Maximum	37mm	183mm	45mm	237mm
Limit per BCBC 2006	72mm	900mm	72mm	900mm

<b>Beam Force</b>	<b>Force</b>	<b>Loadcase</b>
Maximum shear force	150kN	Seismic Y
Maximum bending moment	182kNm	Seismic Y

<b>Wall Panels</b>	<b>Stress</b>	<b>Loadcase</b>
Maximum axial stress	8.7 N/mm <sup>2</sup>	Seismic Y
Maximum shear stress	1.0 N/mm <sup>2</sup>	Seismic Y

### Option 2 - 20-Storey with Core & Internal Walls

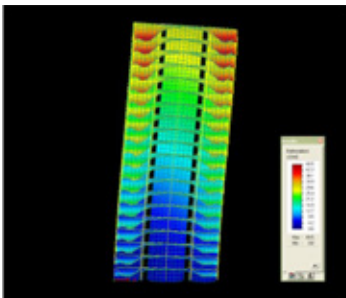
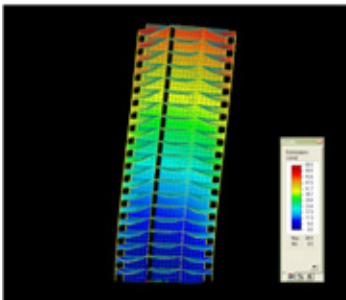

<b>Deflection</b>	<b>Wind X</b>	<b>EQ X</b>	<b>Wind Y</b>	<b>EQ Y</b>
Maximum	36mm	141mm	41mm	198mm
Limit per BCBC 2006	120mm	1500mm	120mm	1500mm

<b>Beam Force</b>	<b>Force</b>	<b>Loadcase</b>
Maximum shear force	110kN	Seismic Y
Maximum bending moment	140kNm	Seismic Y

<b>Wall Panels</b>	<b>Stress</b>	<b>Loadcase</b>
Maximum axial stress	9.8 N/mm <sup>2</sup>	Seismic Y
Maximum shear stress	1.5 N/mm <sup>2</sup>	Seismic Y

Option 3 - 20-Storey with Core & Perimeter Walls

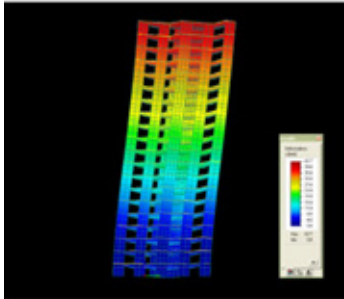

Deflection	Wind X	EQ X	Wind Y	EQ Y
Maximum	34mm	222mm	44mm	318mm
Limit per BCBC 2006	120mm	1500mm	120mm	1500mm

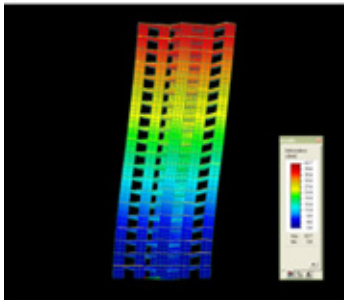

Beam Force	Force	Loadcase
Maximum shear force	130kN	Seismic Y
Maximum bending moment	162kNm	Seismic Y

Wall Panels	Stress	Loadcase
Maximum axial stress	6.5 N/mm <sup>2</sup>	Seismic Y
Maximum shear stress	1.5 N/mm <sup>2</sup>	Seismic Y

Option 4 - 30-Storey with Core, Internal Walls & Perimeter Walls

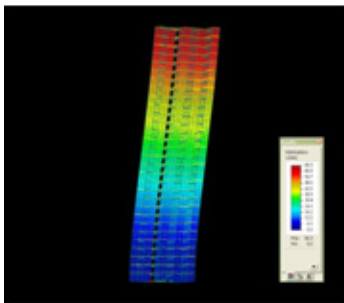

Deflection	Wind X	EQ X	Wind Y	EQ Y
Maximum	37mm	133mm	56mm	211mm
Limit per BCBC 2006	180mm	2250mm	180mm	2250mm

Beam Force	Force	Loadcase
Maximum shear force	115kN	Wind X
Maximum bending moment	142kNm	Wind X

Wall Panels	Stress	Loadcase
Maximum axial stress	8.5 N/mm <sup>2</sup>	Wind Y
Maximum shear stress	2.0 N/mm <sup>2</sup>	Wind Y

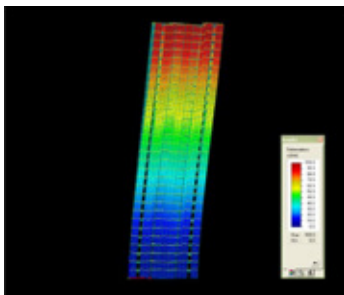

Option 1 - 12-Storey with Core

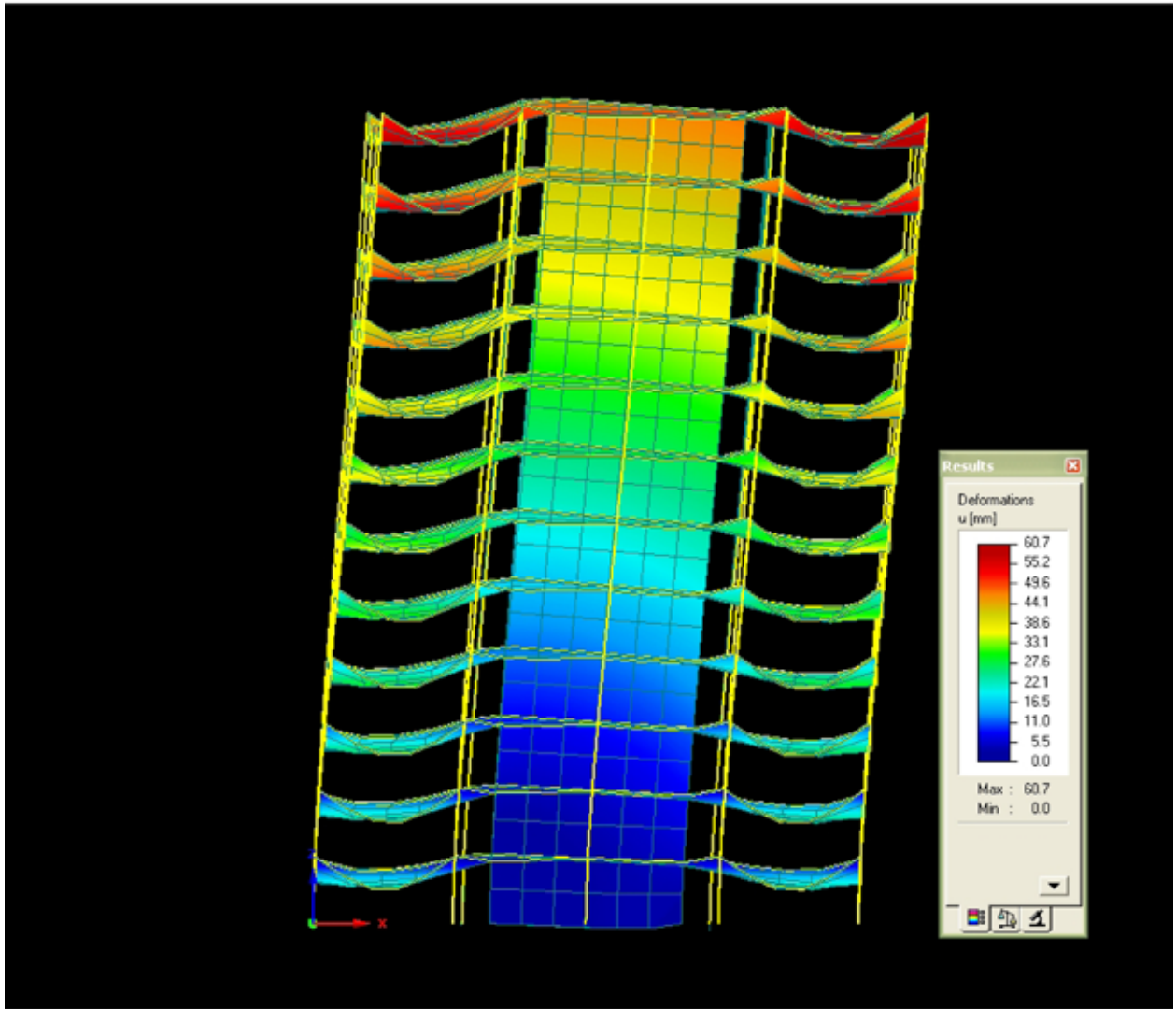

Deflection in X – DL + EQ-X (not factored by RdRo)

Option 1 - 12-Storey with Core

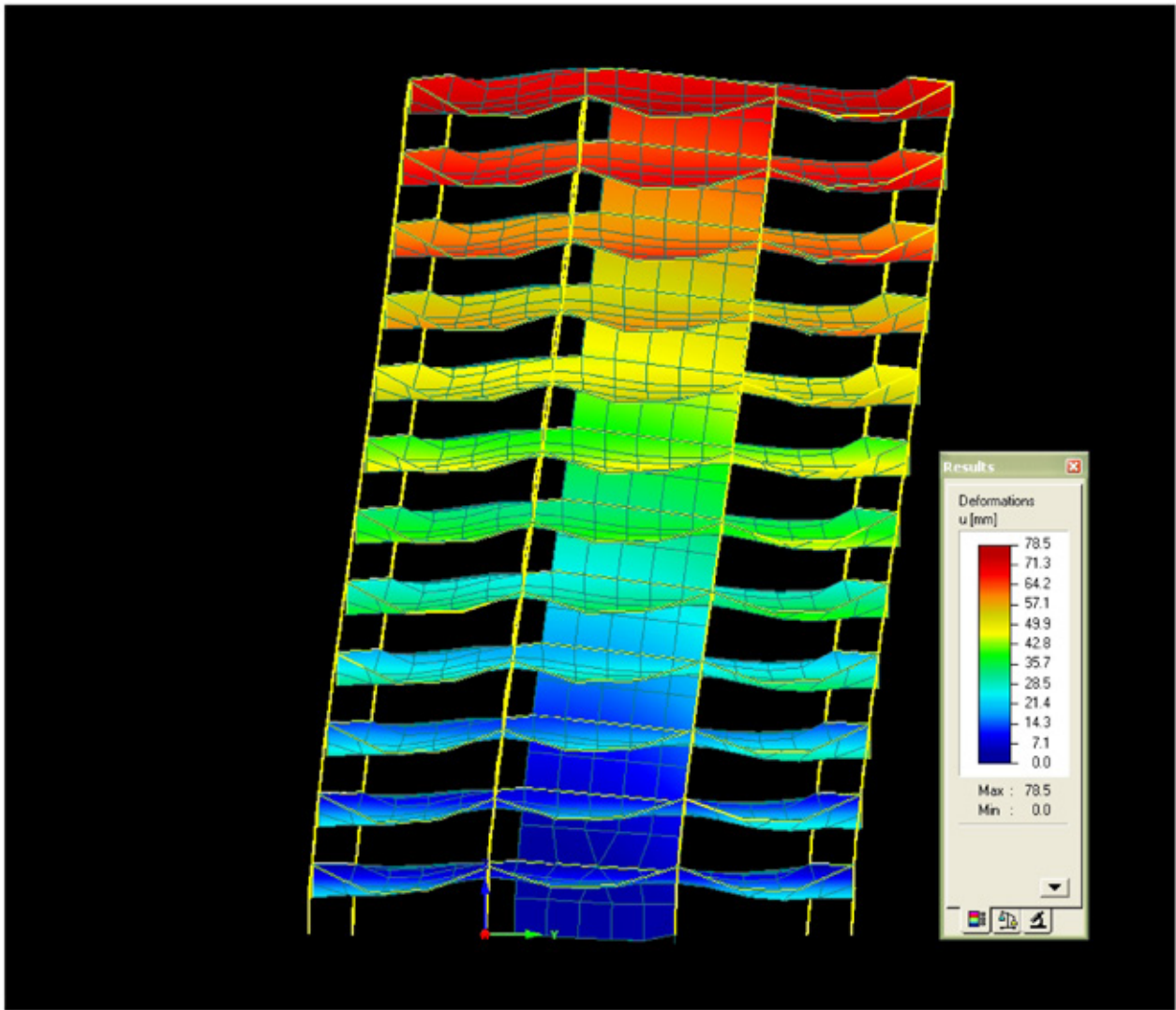

Deflection in Y – DL + EQ-Y (not factored by RdRo)

Option 1 - 12-Storey with Core

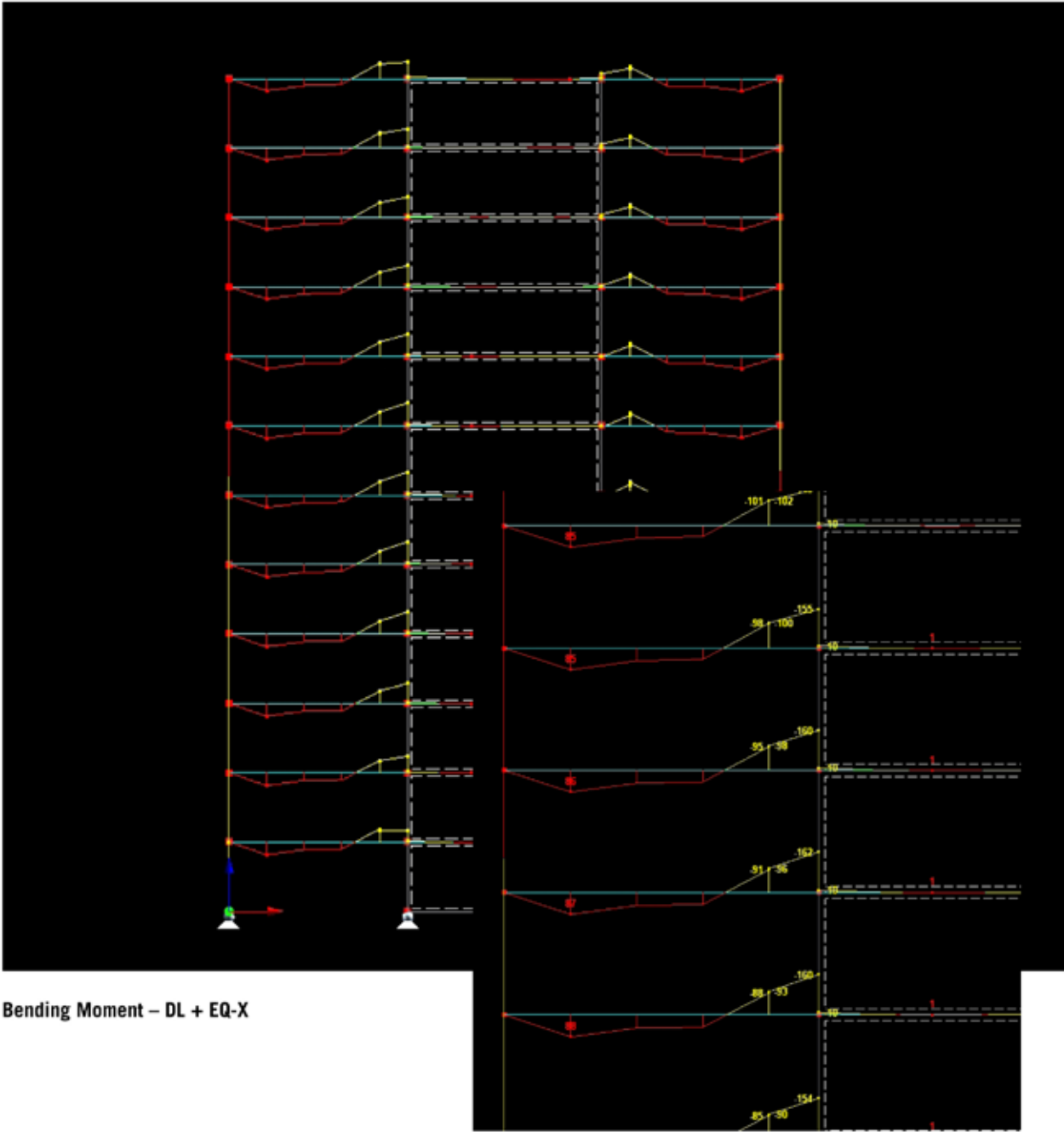

Bending Moment – DL + EQ-X



Option 1 - 12-Storey with Core

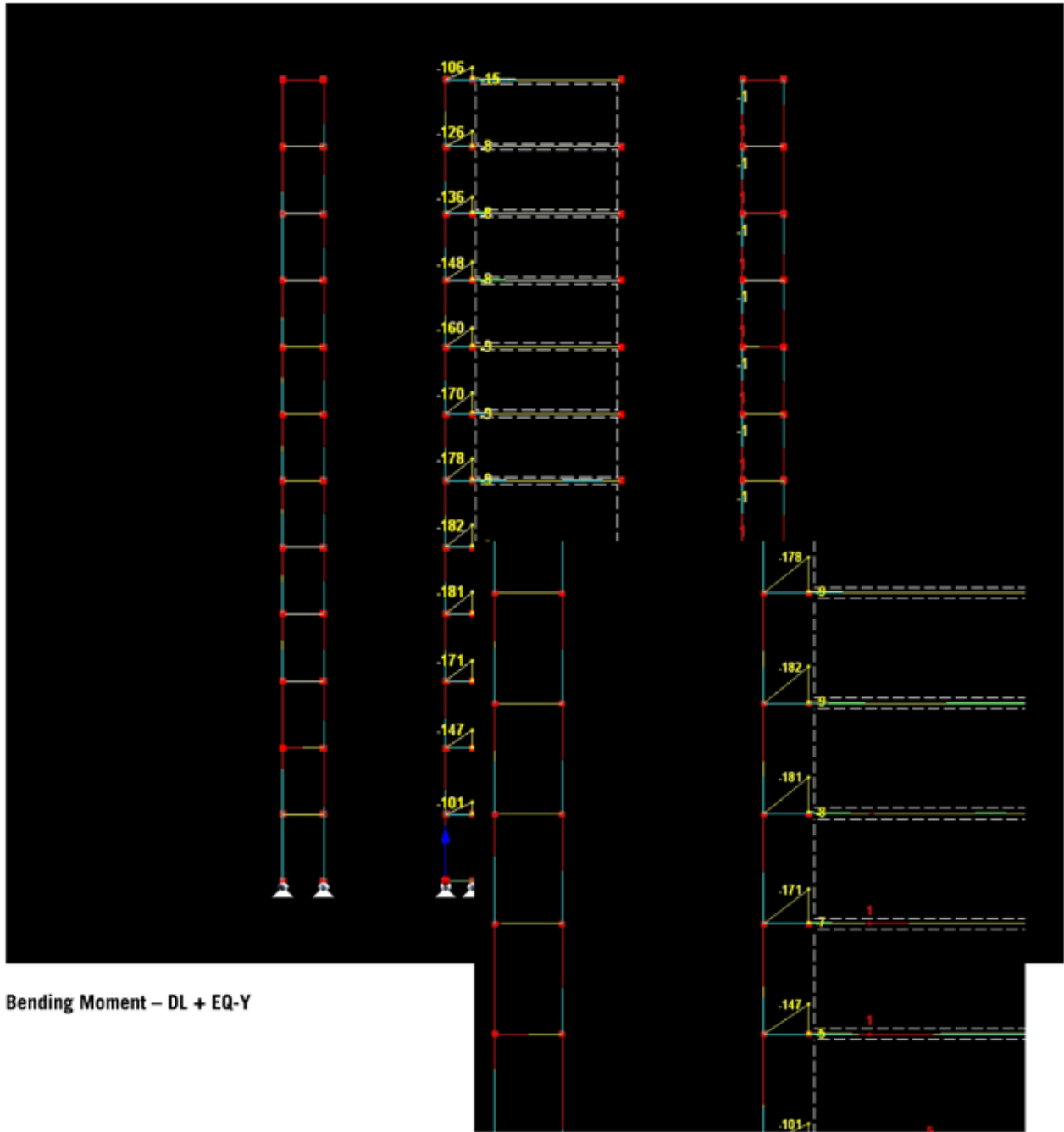

Option 2 - 20-Storey with Core & Internal Walls

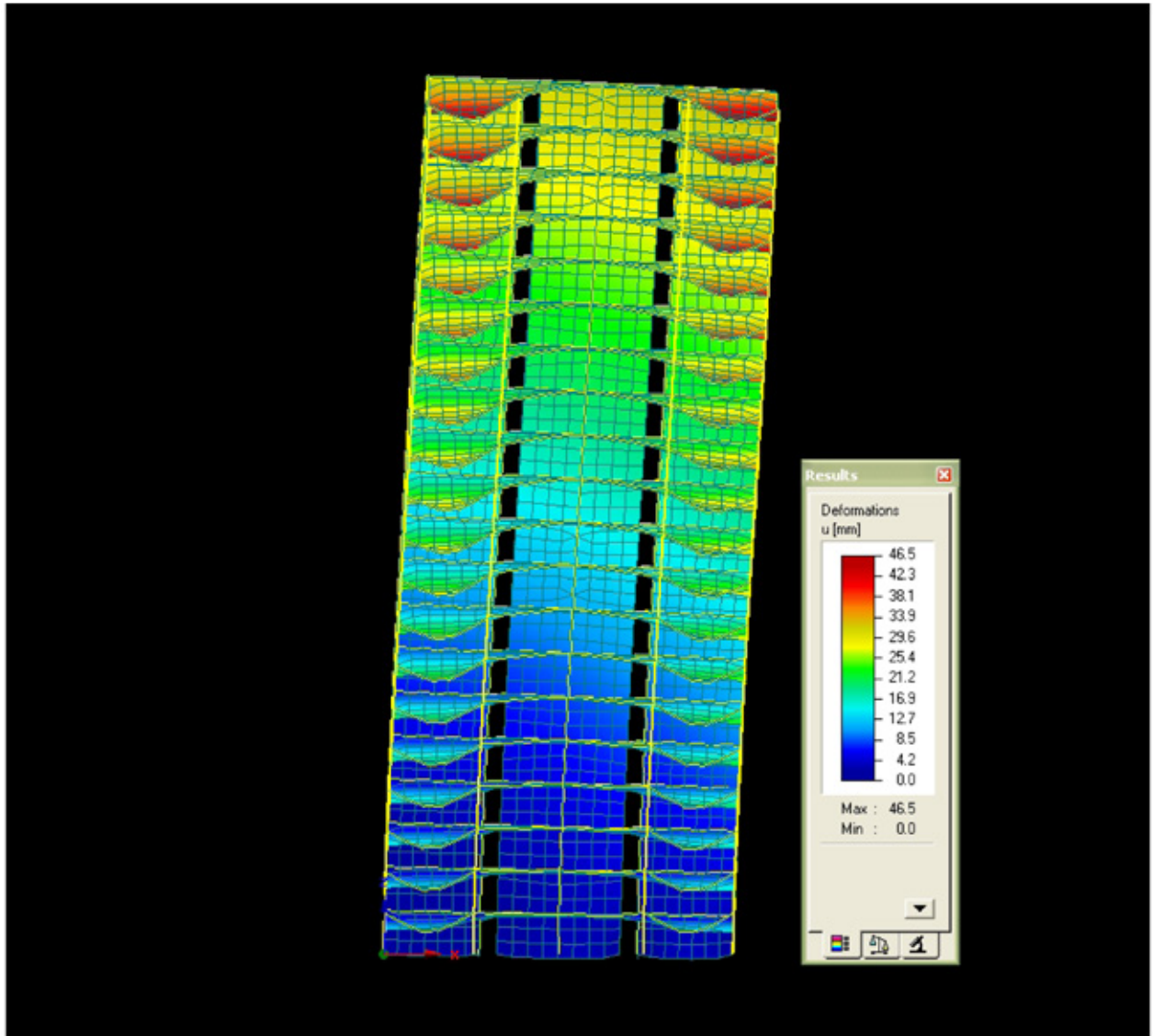

Deflection in X – DL + EQ-X (not factored by RdRo)

Option 2 - 20-Storey with Core & Internal Walls

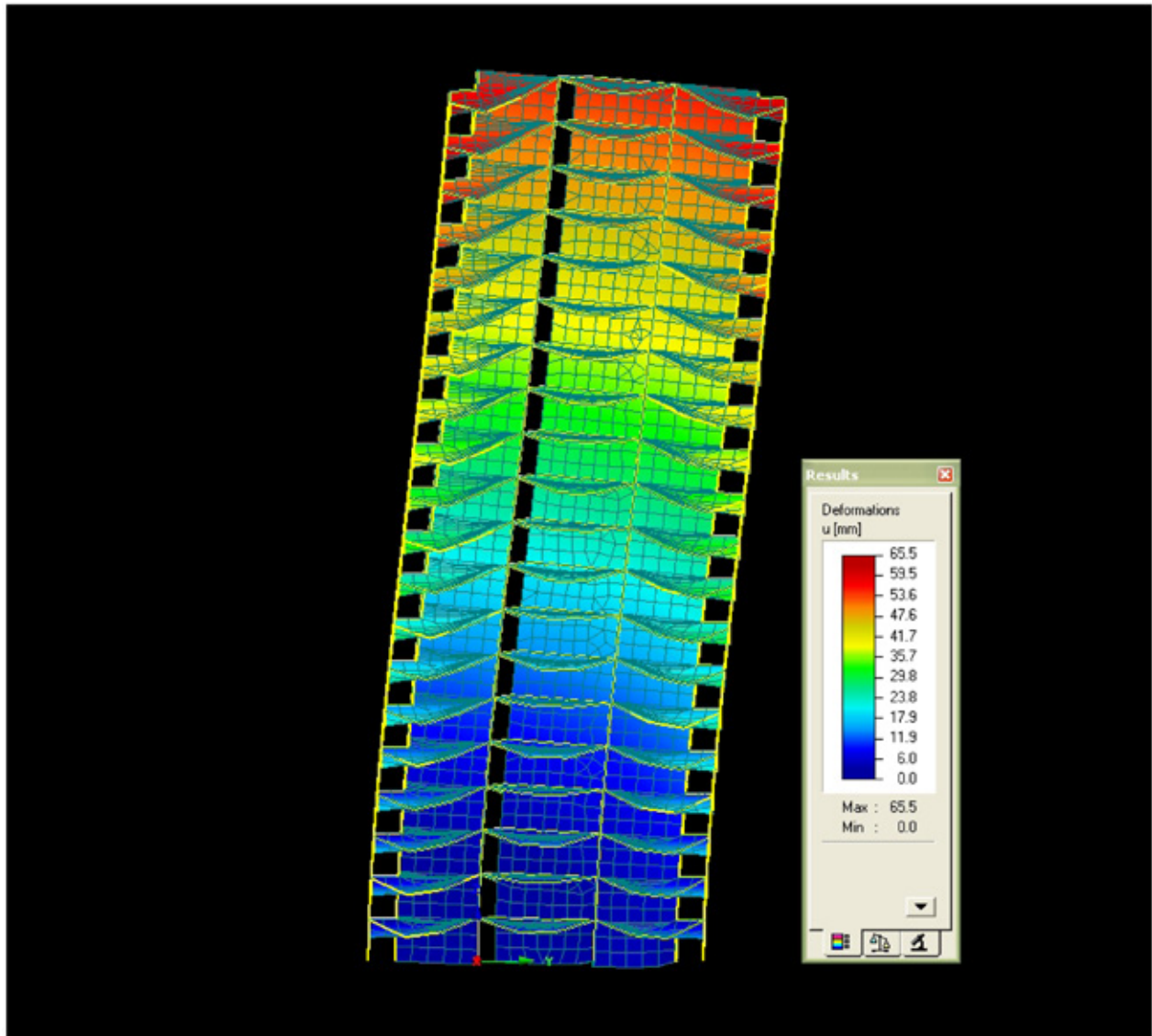

Deflection in Y – DL + EQ-Y (not factored by RdRo)

Option 2 - 20-Storey with Core & Internal Walls

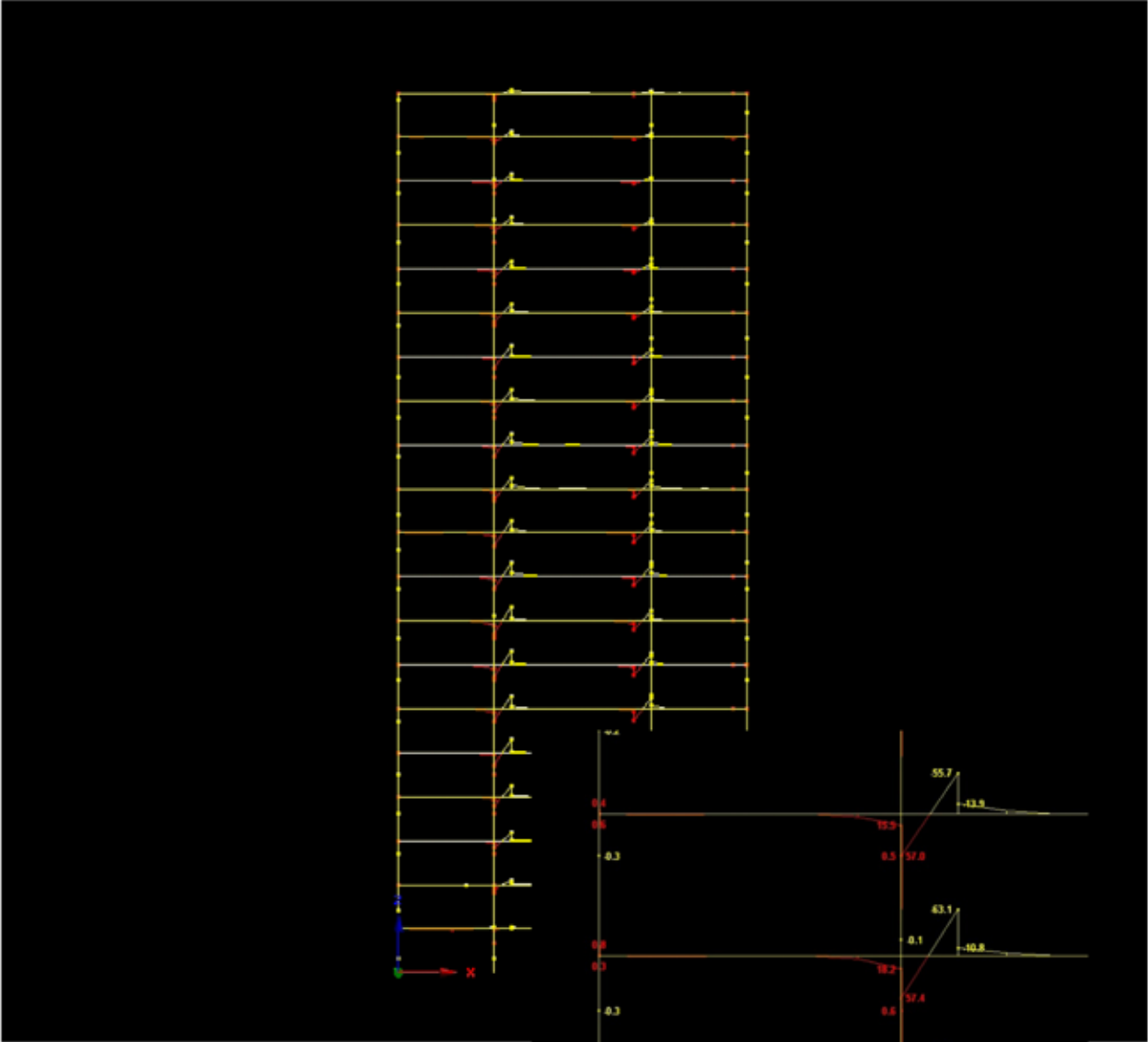

Bending Moment – DL + EQ-X

Option 2 - 20-Storey with Core & Internal Walls

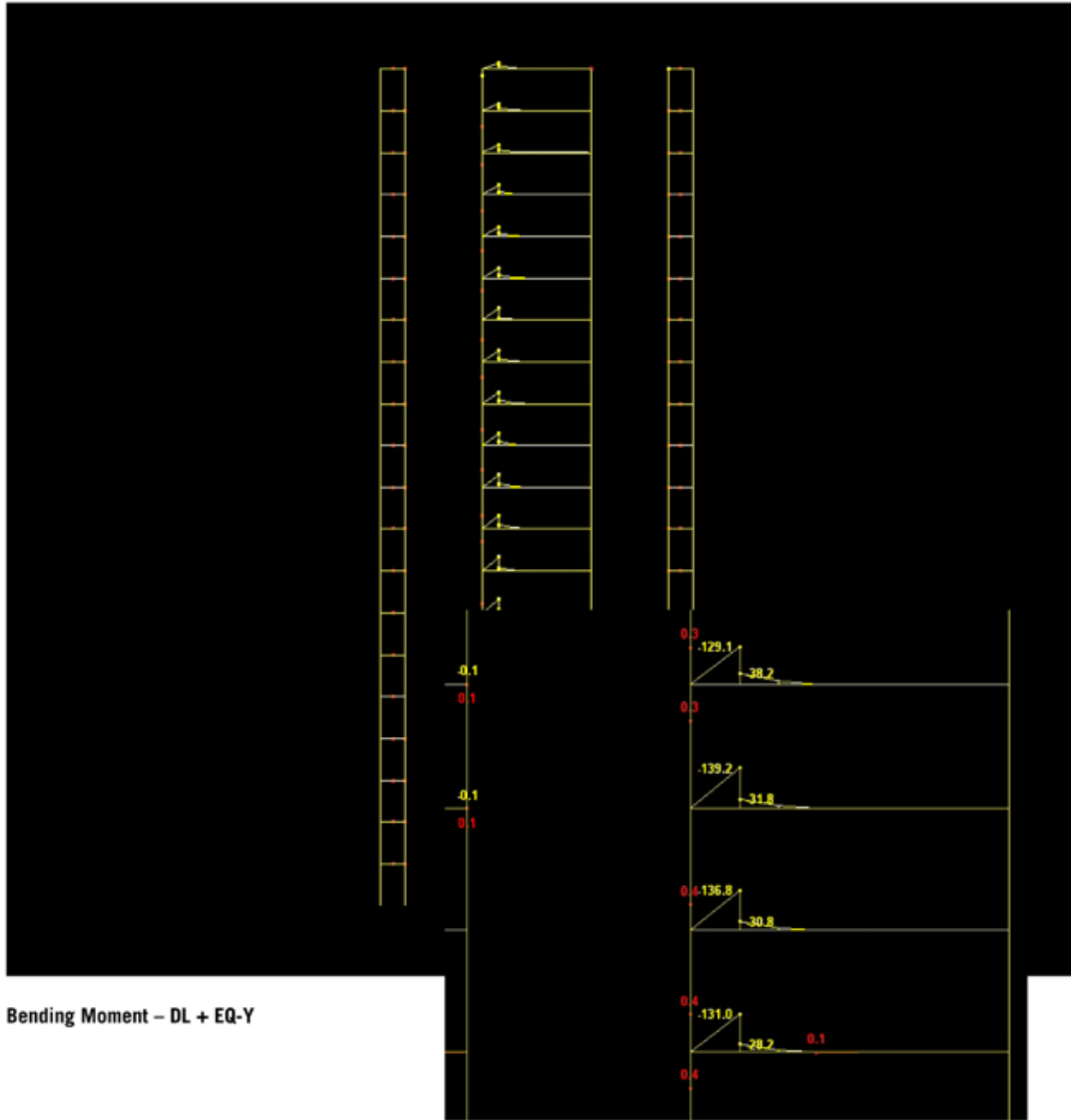

Bending Moment – DL + EQ-Y

Option 3 - 20-Storey with Core & Perimeter Walls

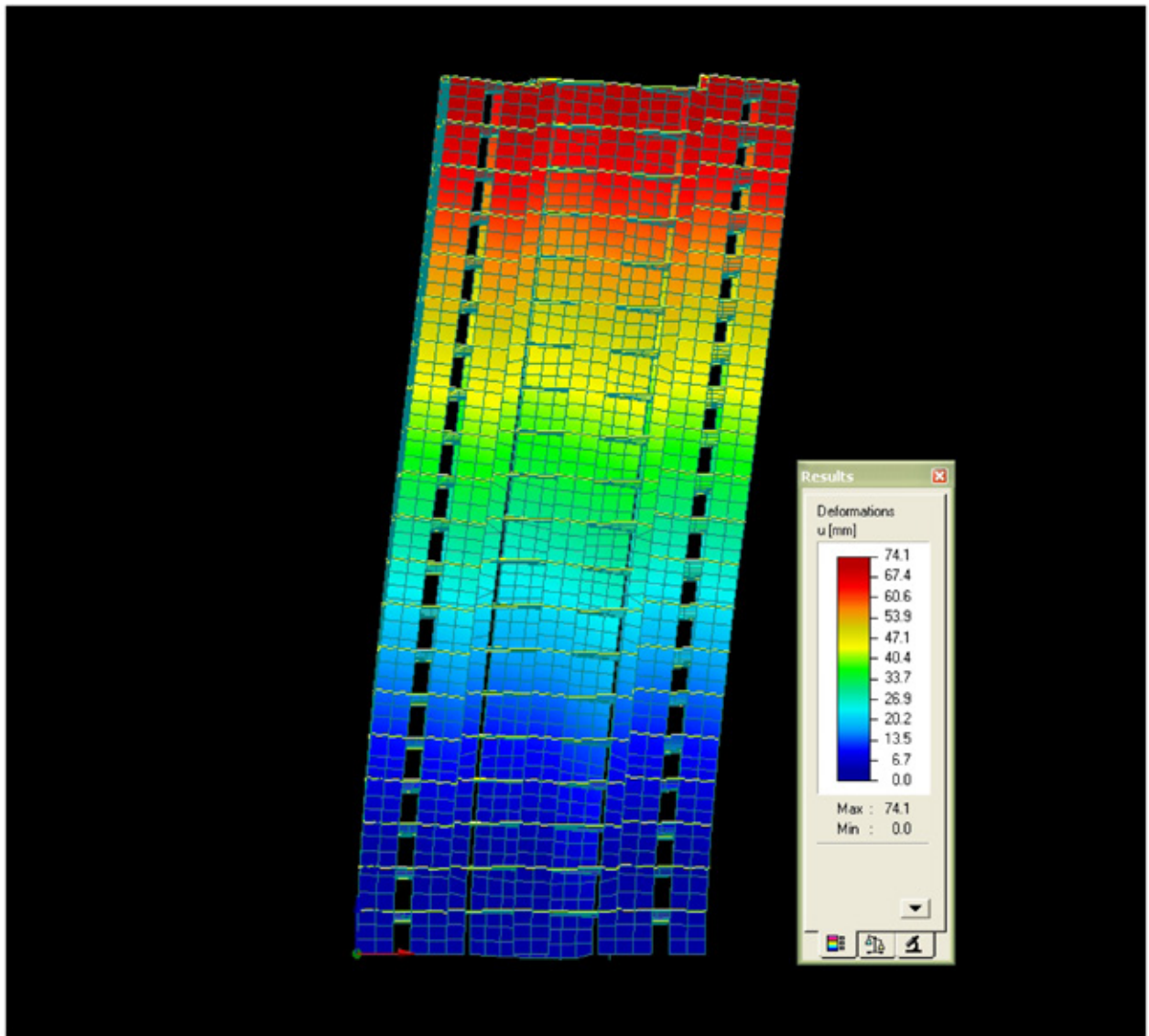

Deflection in X – DL + EQ-X (not factored by RdRo)

Option 3 - 20-Storey with Core & Perimeter Walls

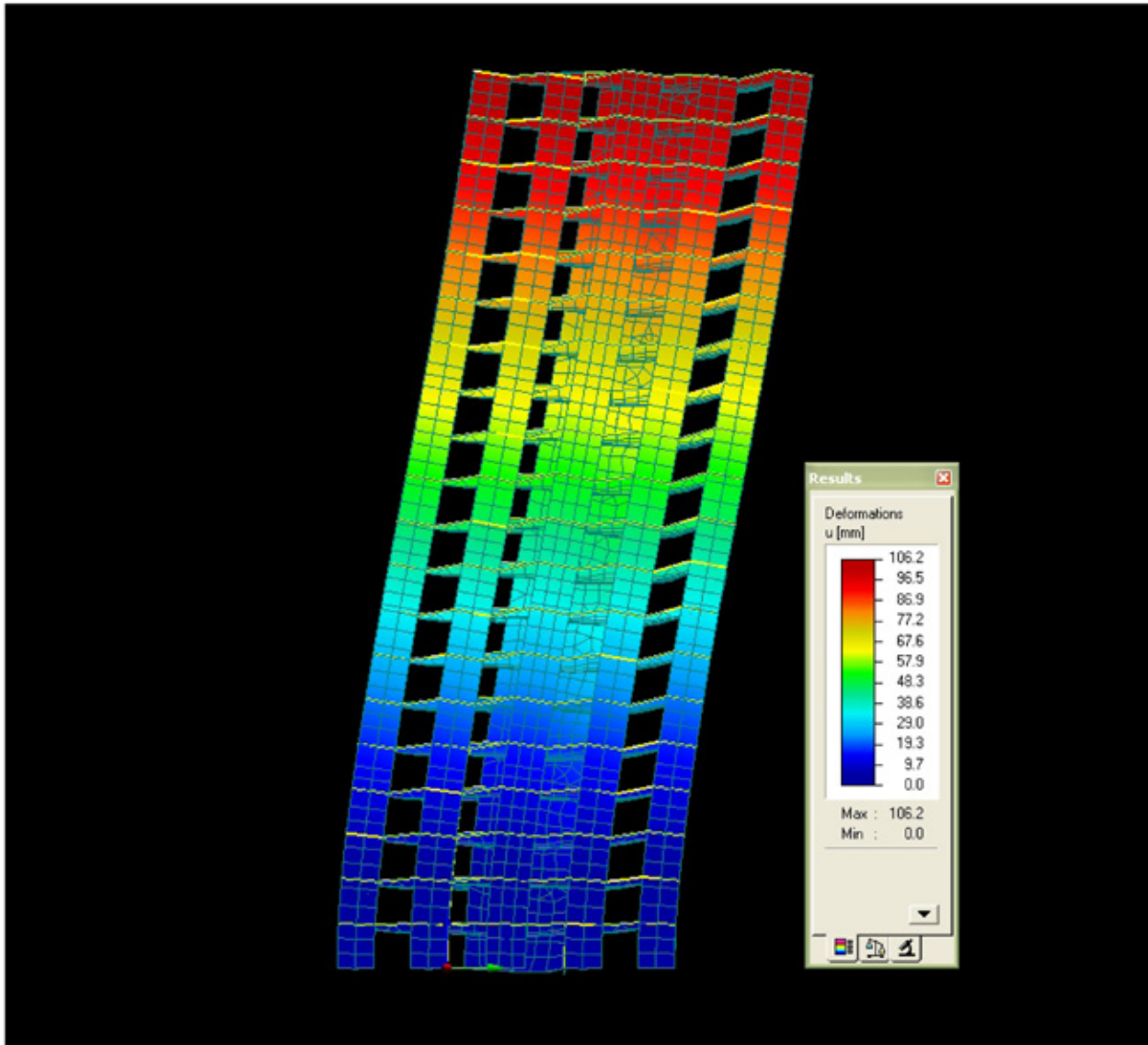

Deflection in Y – DL + EQ-Y (not factored by RdRo)

Option 3 - 20-Storey with Core & Perimeter Walls

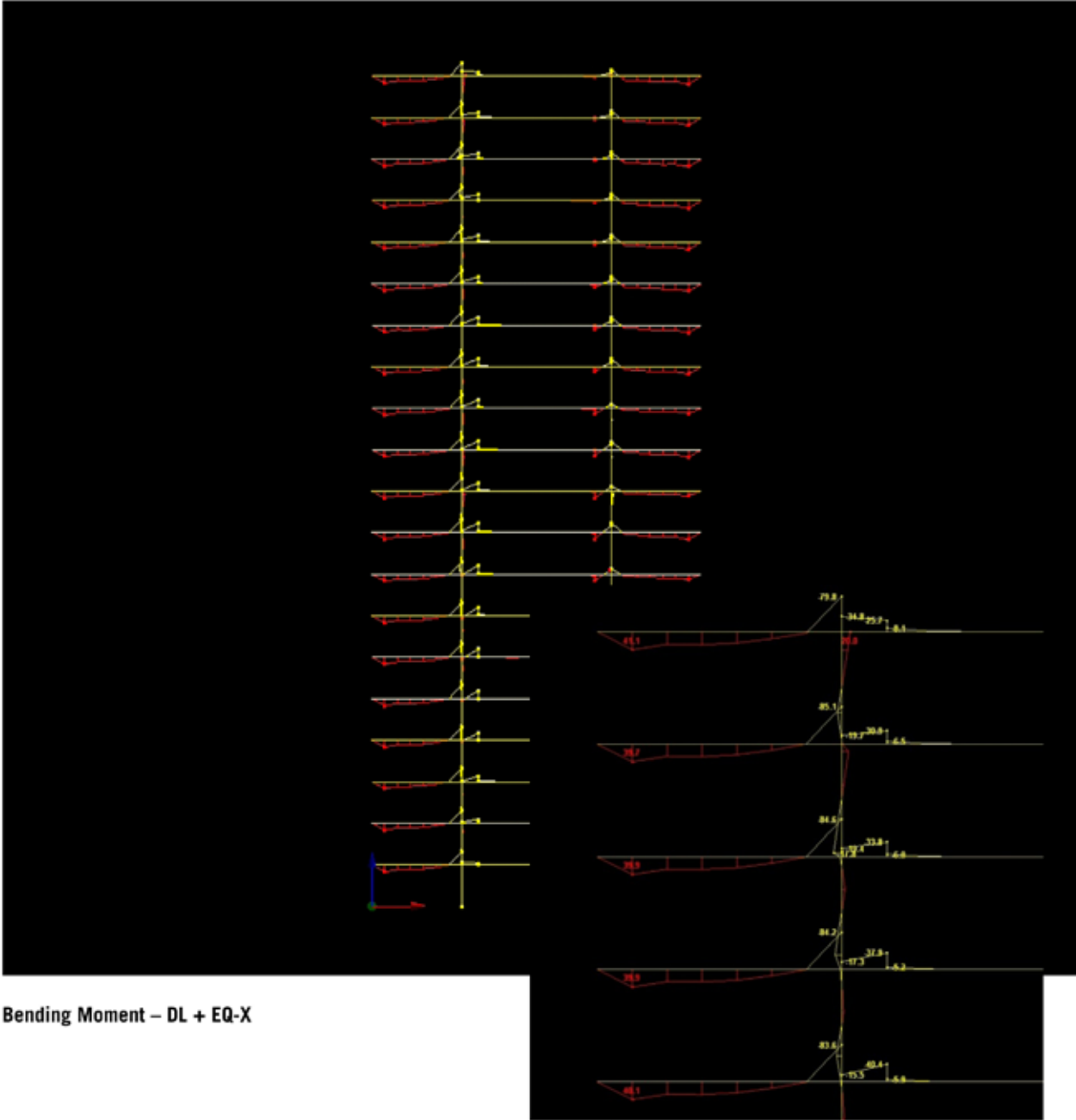

Bending Moment – DL + EQ-X



Option 3 - 20-Storey with Core & Perimeter Walls

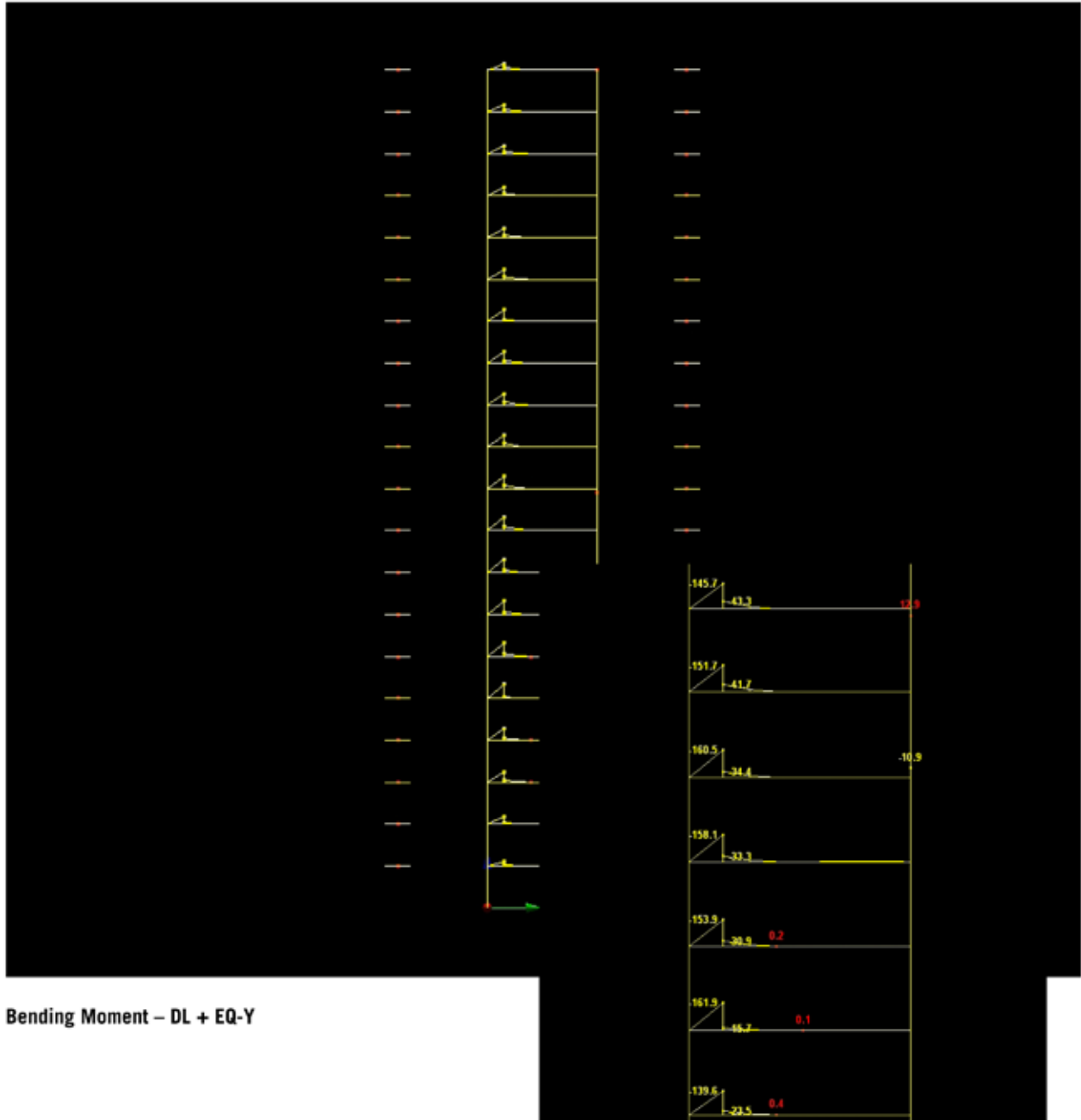

Option 4 - 30-Storey with Core, Internal Walls & Perimeter Walls

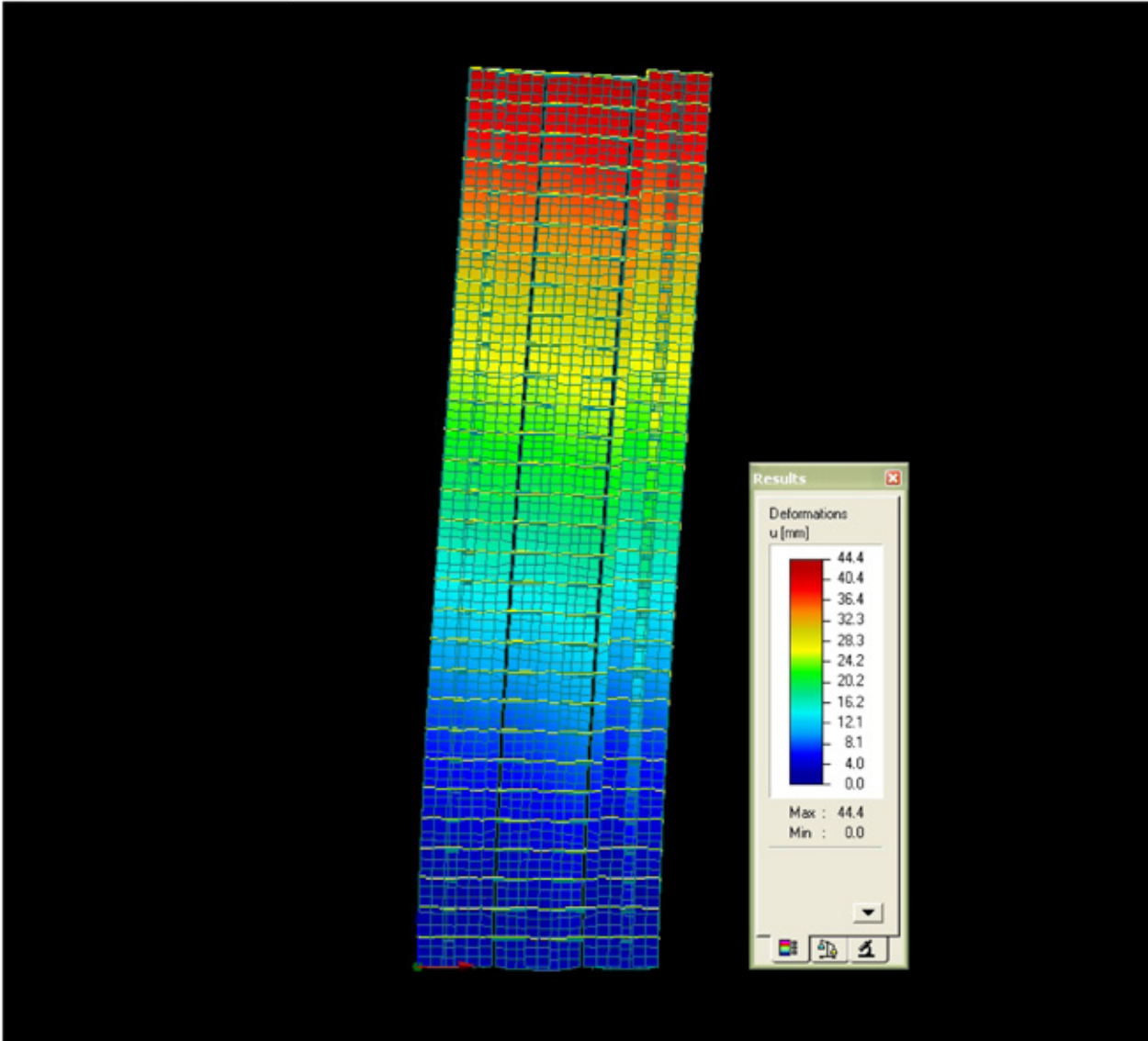

Deflection in X – DL + EQ-X (not factored by RdRo)

Option 4 - 30-Storey with Core, Internal Walls & Perimeter Walls

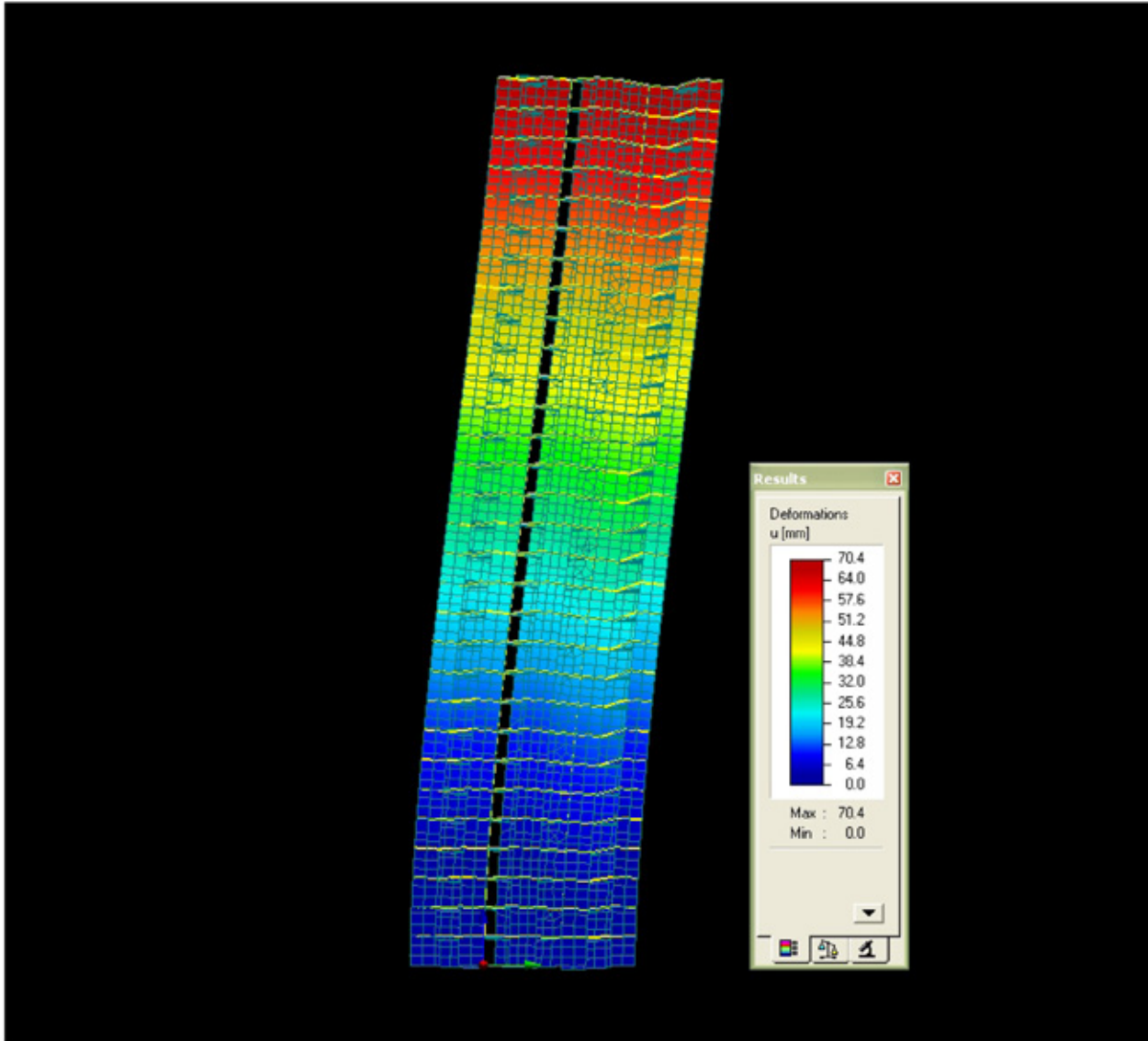

Deflection in Y – DL + EQ-Y (not factored by RdRo)

Option 4 - 30-Storey with Core, Internal Walls & Perimeter Walls

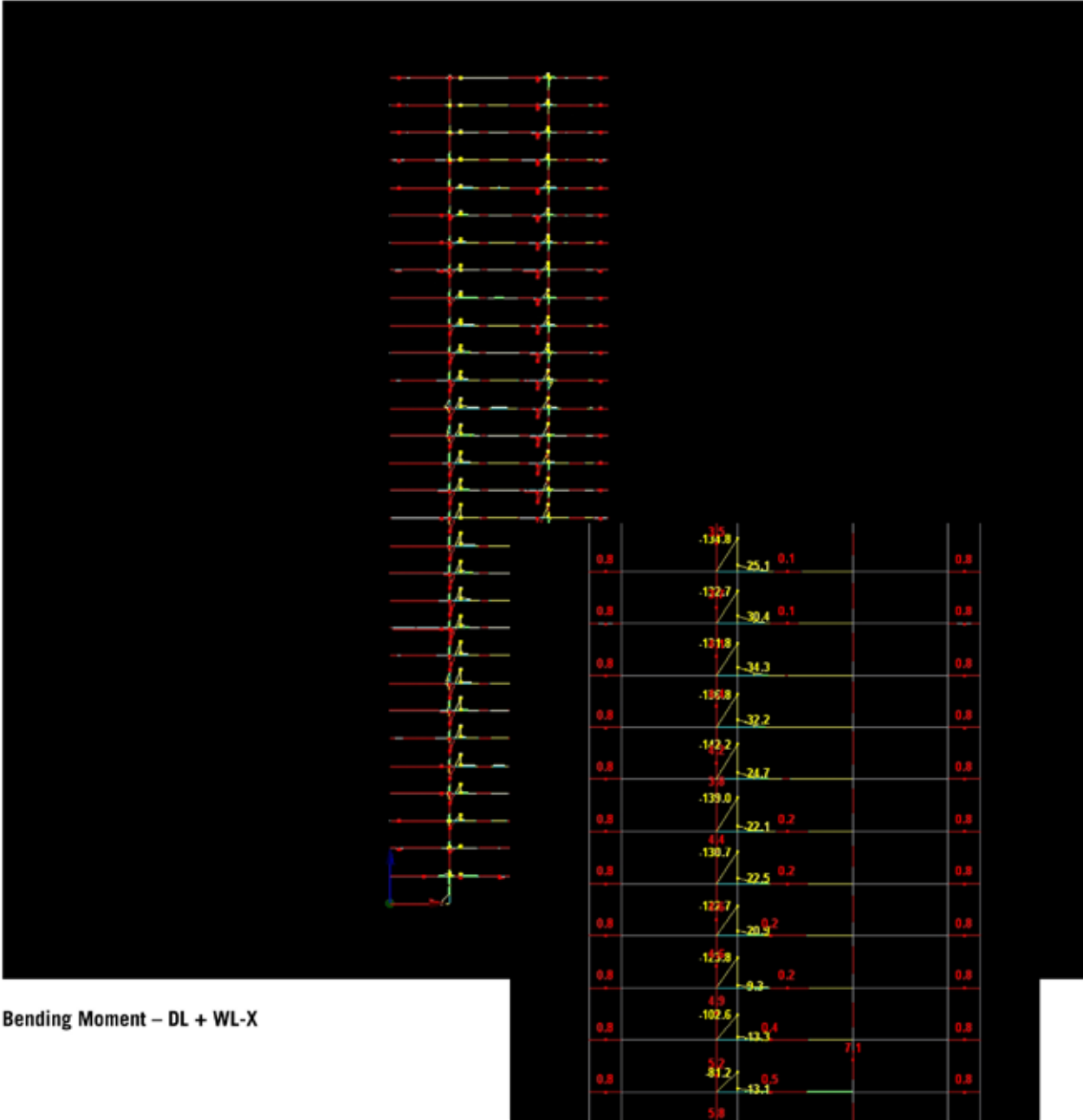

Bending Moment – DL + WL-X

Option 4 - 30-Storey with Core, Internal Walls & Perimeter Walls

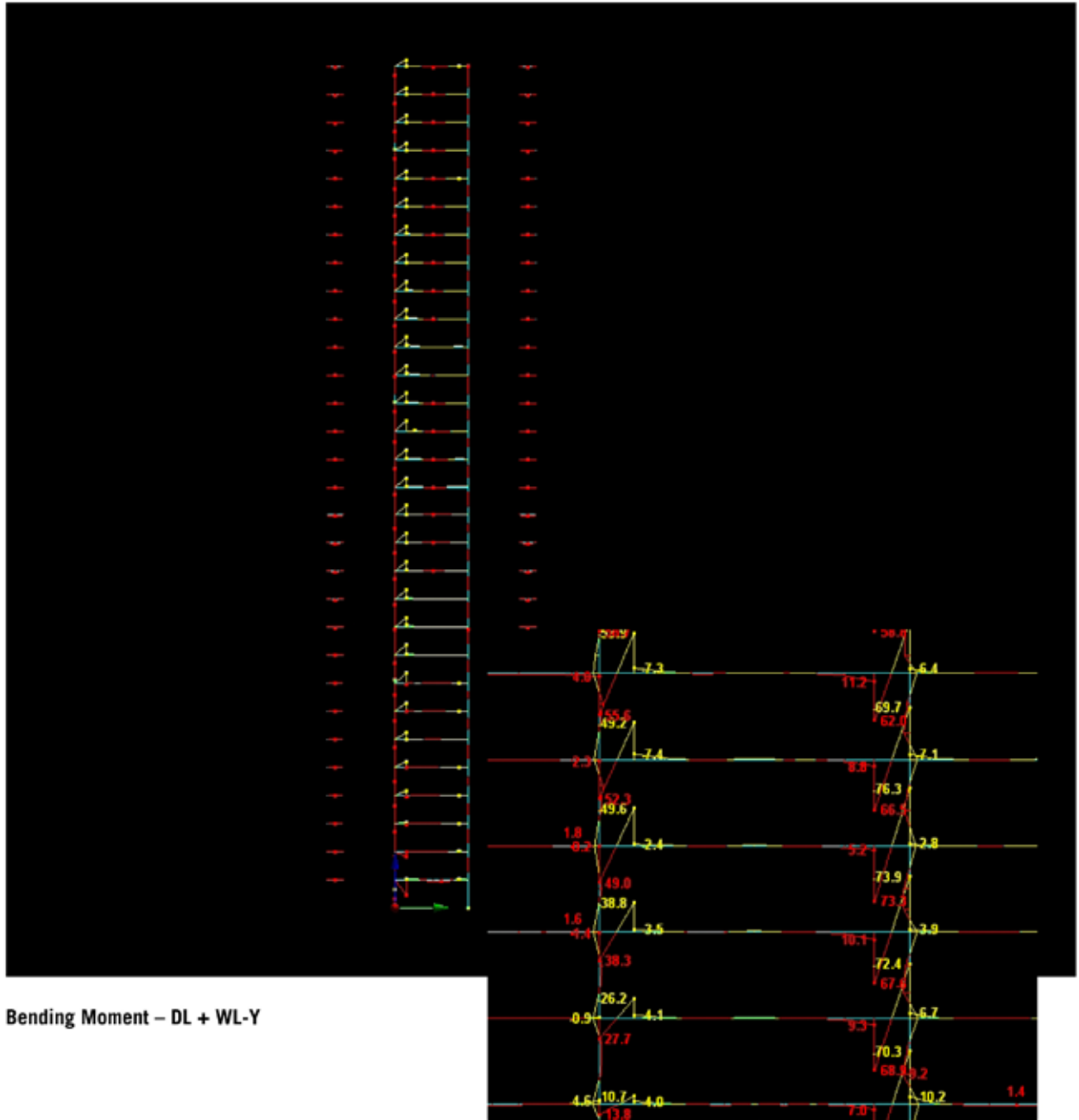

Bending Moment – DL + WL-Y

## Appendix B

## Appendix B: BTY Cost Documentation

The following documentation was used as the basis for preparing the cost estimate:

Drawing	Description	Date
<b>Structural</b>		
DS-S01	Key Plan	March 9, 2011
DS-S02	Mat Type 1/Type 2	March 9, 2011
DS-S03	Shear Wall Header Beam	March 9, 2011
DS-S04	Shear Wall at Bayline 2, Shear Wall Reinforcing Plan Up to 12 Storeys	March 9, 2011
DS-S05	Shear Wall btw Bayline 2 & 3, Shear Wall Reinforcing Plan Up to 12 Storeys	March 9, 2011
DS-S06	Shear Wall at Bayline 3, Shear Wall Reinforcing Plan Up to 12 Storeys	March 9, 2011
DS-S07	Shear Wall at Bayline 2, Shear Wall Reinforcing Plan Up to 20 Storeys	March 9, 2011
DS-S08	Shear Wall btw Bayline 2 & 3, Shear Wall Reinforcing Plan Up to 20 Storeys	March 9, 2011
DS-S09	Shear Wall at Bayline 3, Shear Wall Reinforcing Plan Up to 20 Storeys	March 9, 2011
DS-S10	Shear Wall at Bayline 2, Shear Wall Reinforcing Plan Up to 30 Storeys	March 9, 2011
DS-S11	Shear Wall btw Bayline 2 & 3, Shear Wall Reinforcing Plan Up to 30 Storeys	March 9, 2011
DS-S12	Shear Wall at Bayline 3, Shear Wall Reinforcing Plan Up to 30 Storeys	March 9, 2011
<b>Architectural</b>	Proposed Tower Solutions - Applied & Theoretical Plans (Option 1 to Option 4)	March 2011
	Sequencing plan (from PCL)	March 2011

## Option 1-3 Project Cost Comparisons

### Option 1 – 12-Storey Building

	Base Case (Concrete)	Study Case (Wood) (Encapsulation Method)	Study Case (Wood) (Charring Method)
<b>A. LAND COST</b>	\$0	\$0	\$0
1 Land (Excluded)	0	0	0
<b>B. CONSTRUCTION</b>	<b>\$13,801,400</b>	<b>\$14,180,400</b>	<b>\$13,911,700</b>
1 Building	13,801,400	14,180,400	13,911,700
2 Site Development & Parking (excluded)	0	0	0
<b>C. PROFESSIONAL FEES (9%)</b>	<b>\$1,242,100</b>	<b>\$1,276,200</b>	<b>\$1,252,100</b>
1 Project Management			
2 Architect / Engineers / Cost Consultant			
3 Other Consultants			
<b>D. PERMITS FEES &amp; TAXES (5%)</b>	<b>\$690,100</b>	<b>\$709,000</b>	<b>\$695,600</b>
1 DCC / DCL / GVRD			
2 Building Permits			
<b>E. FINANCING</b>	<b>\$981,400</b>	<b>\$840,300</b>	<b>\$824,400</b>
1 Financing / Legal / Inspection			
<b>F. PROJECT CONTINGENCY (5%)</b>	<b>\$835,800</b>	<b>\$850,300</b>	<b>\$834,200</b>
<b>SUB-TOTAL</b>	<b>\$17,550,800</b>	<b>\$17,856,200</b>	<b>\$17,518,000</b>
<b>I HARMONIZED SALES TAX (Excluded)</b>	<b>\$0</b>	<b>\$0</b>	<b>\$0</b>
<b>TOTAL PROJECT COST (2011 Dollars)</b>	<b>\$17,550,800</b>	<b>\$17,856,200</b>	<b>\$17,518,000</b>
<b>J ESCALATION</b>	<b>\$0</b>	<b>\$0</b>	<b>\$0</b>
1 Escalation Reserve (excluded)			
<b>ESCALATED PROJECT COST (2011 Dollars)</b>	<b>\$17,550,800</b>	<b>\$17,856,200</b>	<b>\$17,518,000</b>
Gross Floor Area	61,920 sqft	61,920 sqft	61,920 sqft
Total Construction Cost \$/sqft	\$223 /sqft	\$229 /sqft	\$225 /sqft
Total Project Cost \$/sqft	\$283 /sqft	\$288 /sqft	\$283 /sqft



Option 2 – 20-Storey Building (Alternative Design No. 1)

	Base Case (Concrete)	Study Case (Wood) (Encapsulation Method)	Study Case (Wood) (Charring Method)
<b>A. LAND COST</b>	\$0	\$0	\$0
1 Land (Excluded)	0	0	0
<b>B. CONSTRUCTION</b>	<b>\$23,213,700</b>	<b>\$24,113,500</b>	<b>\$23,574,500</b>
1 Building	23,213,700	24,113,500	23,574,500
2 Site Development & Parking (excluded)	0	0	0
<b>C. PROFESSIONAL FEES (9%)</b>	<b>\$2,089,200</b>	<b>\$2,170,200</b>	<b>\$2,121,700</b>
1 Project Management			
2 Architect / Engineers / Cost Consultant			
3 Other Consultants			
<b>D. PERMITS FEES &amp; TAXES (5%)</b>	<b>\$1,160,700</b>	<b>\$1,205,700</b>	<b>\$1,178,700</b>
1 DCC / DCL / GVRD			
2 Building Permits			
<b>E. FINANCING</b>	<b>\$2,201,100</b>	<b>\$2,024,800</b>	<b>\$1,979,500</b>
1 Financing / Legal / Inspection			
<b>F. PROJECT CONTINGENCY (5%)</b>	<b>\$1,433,200</b>	<b>\$1,475,700</b>	<b>\$1,442,700</b>
<b>SUB-TOTAL</b>	<b>\$30,097,900</b>	<b>\$30,989,900</b>	<b>\$30,297,100</b>
<b>I HARMONIZED SALES TAX (Excluded)</b>	<b>\$0</b>	<b>\$0</b>	<b>\$0</b>
<b>TOTAL PROJECT COST (2011 Dollars)</b>	<b>\$30,097,900</b>	<b>\$30,989,900</b>	<b>\$30,297,100</b>
<b>J ESCALATION</b>	<b>\$0</b>	<b>\$0</b>	<b>\$0</b>
1 Escalation Reserve (excluded)			
<b>ESCALATED PROJECT COST (2011 Dollars)</b>	<b>\$30,097,900</b>	<b>\$30,989,900</b>	<b>\$30,297,100</b>
Gross Floor Area	103,200 sqft	103,200 sqft	103,200 sqft
Total Construction Cost \$/sqft	\$225 /sqft	\$234 /sqft	\$228 /sqft
Total Project Cost \$/sqft	\$292 /sqft	\$300 /sqft	\$294 /sqft

Option 3 – 20-Storey (Alternative Design No. 2)

	Base Case (Concrete)	Study Case (Wood) (Encapsulation Method)	Study Case (Wood) (Charring Method)
<b>A. LAND COST</b>	<b>\$0</b>	<b>\$0</b>	<b>\$0</b>
1 Land (Excluded)	0	0	0
<b>B. CONSTRUCTION</b>	<b>\$23,213,700</b>	<b>\$24,271,900</b>	<b>\$23,757,000</b>
1 Building	23,213,700	24,271,900	23,757,000
2 Site Development & Parking (excluded)	0	0	0
<b>C. PROFESSIONAL FEES (9%)</b>	<b>\$2,089,200</b>	<b>\$2,184,500</b>	<b>\$2,138,100</b>
1 Project Management			
2 Architect / Engineers / Cost Consultant			
3 Other Consultants			
<b>D. PERMITS FEES &amp; TAXES (5%)</b>	<b>\$1,160,700</b>	<b>\$1,213,600</b>	<b>\$1,187,900</b>
1 DCC / DCL / GVRD			
2 Building Permits			
<b>E. FINANCING</b>	<b>\$2,201,100</b>	<b>\$2,008,600</b>	<b>\$1,966,000</b>
1 Financing / Legal / Inspection			
<b>F. PROJECT CONTINGENCY (5%)</b>	<b>\$1,433,200</b>	<b>\$1,483,900</b>	<b>\$1,452,500</b>
<b>SUB-TOTAL</b>	<b>\$30,097,900</b>	<b>\$31,162,500</b>	<b>\$30,501,500</b>
<b>I HARMONIZED SALES TAX (Excluded)</b>	<b>\$0</b>	<b>\$0</b>	<b>\$0</b>
<b>TOTAL PROJECT COST (2011 Dollars)</b>	<b>\$30,097,900</b>	<b>\$31,162,500</b>	<b>\$30,501,500</b>
<b>J ESCALATION</b>	<b>\$0</b>	<b>\$0</b>	<b>\$0</b>
1 Escalation Reserve (excluded)			
<b>ESCALATED PROJECT COST (2011 Dollars)</b>	<b>\$30,097,900</b>	<b>\$31,162,500</b>	<b>\$30,501,500</b>
Gross Floor Area	103,200 sqft	103,200 sqft	103,200 sqft
Total Construction Cost \$/sqft	\$225 /sqft	\$235 /sqft	\$230 /sqft
Total Project Cost \$/sqft	\$292 /sqft	\$302 /sqft	\$296 /sqft

# Option 1-3 Construction Cost Comparisons

## OPTION 1 COMPARISON

NUMBER OF UNITS:  
GROSS FLOOR AREA:

66 Unit  
61,920 sqft

Element	Concrete (a)	Wood (Encap) (b)	Variance (a) - (b)		Wood (Charring) (c)	Variance (a) - (c)		Comments
<b>A1 SUBSTRUCTURE</b>								
A11.1 Standard Foundations	433,400	309,600	123,800	29%	309,600	123,800	29%	Foundations to Timber Building will be lighter
A11.2 Special Foundations	0	0	0	0%	0	0	0%	
A12 Basement Excavation	1,393,200	1,393,200	0	0%	1,393,200	0	0%	
<b>A2 STRUCTURE</b>								
A21 Lowest Floor Construction	41,300	41,300	0	0%	41,300	0	0%	
A22.1 Upper Floor Construction	1,325,200	2,331,500	-1,006,300	-76%	2,375,000	-1,049,800	-79%	250mm thick timber panel floor
A22.2 Stair Construction	96,000	129,600	-33,600	-35%	129,600	-33,600	-35%	Timber Stairs construction with conc topping
A23 Roof Construction	103,200	167,700	-64,500	-63%	169,300	-66,100	-64%	169mm thick timber panel roof deck
<b>A3 EXTERIOR ENCLOSURE</b>								
A31 Structural Walls Below Grade	0	0	0	0%	0	0	0%	
A32.1 Walls Above Grade	302,700	302,700	0	0%	302,700	0	0%	
A32.2 Structural Walls Above Grade	0	0	0	0%	0	0	0%	
A32.3 Curtain Walls	1,118,200	1,118,200	0	0%	1,118,200	0	0%	
A33.1 Windows & Louvres	0	0	0	0%	0	0	0%	
A33.2 Glazed Screens	0	0	0	0%	0	0	0%	
A33.3 Doors	100,400	100,400	0	0%	100,400	0	0%	
A34.1 Roof Covering	46,400	46,400	0	0%	46,400	0	0%	
A34.2 Skylights	0	0	0	0%	0	0	0%	
A35 Projections	231,000	231,000	0	0%	231,000	0	0%	
<b>B1 PARTITIONS &amp; DOORS</b>								
B11.1 Fixed Partitions	646,800	722,800	-76,000	-12%	646,800	0	0%	Additional wallboard required for Fire-rating
B11.2 Moveable Partitions	0	0	0	0%	0	0	0%	
B11.3 Structural Partitions	1,176,300	661,400	514,900	44%	661,400	514,900	44%	Solid Timber Core walls in lieu of Concrete
B12 Doors	211,200	211,200	0	0%	211,200	0	0%	
<b>B2 FINISHES</b>								
B21 Floor Finishes	349,800	349,800	0	0%	349,800	0	0%	
B22 Ceiling Finishes	204,600	434,600	-230,000	-112%	204,600	0	0%	Additional wallboard required for Fire-rating
B23 Wall Finishes	277,200	277,200	0	0%	277,200	0	0%	
<b>B3 FITTINGS &amp; EQUIPMENT</b>								
B31.1 Metals	59,400	59,400	0	0%	59,400	0	0%	
B31.2 Millwork	363,000	363,000	0	0%	363,000	0	0%	
B31.3 Specialties	191,400	191,400	0	0%	191,400	0	0%	
B32 Equipment	462,000	462,000	0	0%	462,000	0	0%	
B33.1 Elevators	530,000	530,000	0	0%	530,000	0	0%	
B33.2 Escalators & Moving Walkways	0	0	0	0%	0	0	0%	
B33.3 Material Handling Systems	0	0	0	0%	0	0	0%	
<b>C1 MECHANICAL</b>								
C11 Plumbing and Drainage	666,600	666,600	0	0%	666,600	0	0%	
C12 Fire Protection	216,700	216,700	0	0%	216,700	0	0%	
C13 HVAC	495,000	495,000	0	0%	495,000	0	0%	
C14 Controls	19,800	19,800	0	0%	19,800	0	0%	
<b>C2 ELECTRICAL</b>								
C21 Service & Distribution	277,200	277,200	0	0%	277,200	0	0%	
C22 Lighting, Devices & Heating	475,200	475,200	0	0%	475,200	0	0%	
C23 Systems & Ancillaries	231,000	231,000	0	0%	231,000	0	0%	
<b>Z1 GENERAL REQUIREMENTS &amp; FEES</b>								
Z11 General Requirements	1,155,000	980,000	175,000	15%	980,000	175,000	15%	Timber Construction 2.5 months quicker approx
Z12 Fee	602,200	384,500	217,700	36%	376,700	225,500	37%	Less Management r'qd due to off site detail design
<b>NET BUILDING COST</b>	<b>13,801,400</b>	<b>14,180,400</b>	<b>-379,000</b>	<b>-3%</b>	<b>13,911,700</b>	<b>-110,300</b>	<b>-1%</b>	
<b>Harmonized Sales Tax</b>			<b>0.0%</b>			<b>0.0%</b>		
<b>TOTAL CONSTRUCTION COST (2011 Dollars)</b>	<b>13,801,400</b>	<b>14,180,400</b>	<b>-379,000</b>	<b>-3%</b>	<b>13,911,700</b>	<b>-110,300</b>	<b>-1%</b>	

### Unit Cost Analysis

Cost per sq.ft.:	223	229	-6	-3%	225	-2	-1%
Cost per Unit:	209,112	214,855	-5,742	-3%	210,783	-1,671	-1%

**OPTION 2 COMPARISON**

**NUMBER OF UNITS:  
GROSS FLOOR AREA:**

**114 Unit  
103,200 sqft**

Element	Concrete (a)	Wood (Encap) (b)	Variance (a) - (b)		Wood (Charring) (c)	Variance (a) - (c)		Comments	
<b>A1 SUBSTRUCTURE</b>									
A11.1 Standard Foundations	928,800	516,000	412,800	44%	516,000	412,800	44%	Foundations to Timber Building will be lighter	
A11.2 Special Foundations	0	0	0	0%	0	0	0%		
A12 Basement Excavation	1,857,600	1,857,600	0	0%	1,857,600	0	0%		
<b>A2 STRUCTURE</b>									
A21 Lowest Floor Construction	41,300	41,300	0	0%	41,300	0	0%	250mm thick timber panel floor Timber Stairs construction with conc topping 169mm thick timber panel roof deck	
A22.1 Upper Floor Construction	2,289,000	3,997,900	-1,708,900	-75%	4,069,900	-1,780,900	-78%		
A22.2 Stair Construction	160,000	216,000	-56,000	-35%	216,000	-56,000	-35%		
A23 Roof Construction	103,200	178,500	-75,300	-73%	180,900	-77,700	-75%		
<b>A3 EXTERIOR ENCLOSURE</b>									
A31 Structural Walls Below Grade	0	0	0	0%	0	0	0%		
A32.1 Walls Above Grade	497,900	497,900	0	0%	497,900	0	0%		
A32.2 Structural Walls Above Grade	0	0	0	0%	0	0	0%		
A32.3 Curtain Walls	1,839,500	1,839,500	0	0%	1,839,500	0	0%		
A33.1 Windows & Louvres	0	0	0	0%	0	0	0%		
A33.2 Glazed Screens	0	0	0	0%	0	0	0%		
A33.3 Doors	164,400	164,400	0	0%	164,400	0	0%		
A34.1 Roof Covering	46,400	46,400	0	0%	46,400	0	0%		
A34.2 Skylights	0	0	0	0%	0	0	0%		
A35 Projections	399,000	399,000	0	0%	399,000	0	0%		
<b>B1 PARTITIONS &amp; DOORS</b>									
B11.1 Fixed Partitions	1,117,200	1,331,600	-214,400	-19%	1,117,200	0	0%		Additional wallboard required for Fire-rating
B11.2 Moveable Partitions	0	0	0	0%	0	0	0%		
B11.3 Structural Partitions	2,604,200	2,095,300	508,900	20%	2,095,300	508,900	20%		
B12 Doors	364,800	292,200	72,600	20%	292,200	72,600	20%		Solid Timber Core walls in lieu of Concrete
<b>B2 FINISHES</b>									
B21 Floor Finishes	604,200	604,200	0	0%	604,200	0	0%		
B22 Ceiling Finishes	353,400	736,700	-383,300	-108%	353,400	0	0%	Additional wallboard required for Fire-rating	
B23 Wall Finishes	478,800	478,800	0	0%	478,800	0	0%		
<b>B3 FITTINGS &amp; EQUIPMENT</b>									
B31.1 Metals	102,600	102,600	0	0%	102,600	0	0%		
B31.2 Millwork	627,000	627,000	0	0%	627,000	0	0%		
B31.3 Specialties	330,600	330,600	0	0%	330,600	0	0%		
B32 Equipment	798,000	798,000	0	0%	798,000	0	0%		
B33.1 Elevators	800,000	800,000	0	0%	800,000	0	0%		
B33.2 Escalators & Moving Walkways	0	0	0	0%	0	0	0%		
B33.3 Material Handling Systems	0	0	0	0%	0	0	0%		
<b>C1 MECHANICAL</b>									
C11 Plumbing and Drainage	1,151,400	1,151,400	0	0%	1,151,400	0	0%		
C12 Fire Protection	361,200	361,200	0	0%	361,200	0	0%		
C13 HVAC	855,000	855,000	0	0%	855,000	0	0%		
C14 Controls	34,200	34,200	0	0%	34,200	0	0%		
<b>C2 ELECTRICAL</b>									
C21 Service & Distribution	478,800	478,800	0	0%	478,800	0	0%		
C22 Lighting, Devices & Heating	820,800	820,800	0	0%	820,800	0	0%		
C23 Systems & Ancillaries	399,000	399,000	0	0%	399,000	0	0%		
<b>Z1 GENERAL REQUIREMENTS &amp; FEES</b>									
Z11 General Requirements	1,575,000	1,400,000	175,000	11%	1,400,000	175,000	11%	Timber Construction 2.5 months quicker approx Less Management req'd due to off site detail design	
Z12 Fee	1,030,400	661,600	368,800	36%	645,900	384,500	37%		
<b>NET BUILDING COST</b>	<b>23,213,700</b>	<b>24,113,500</b>	<b>-899,800</b>	<b>-4%</b>	<b>23,574,500</b>	<b>-360,800</b>	<b>-2%</b>		
<b>Harmonized Sales Tax</b>				<b>0.0%</b>			<b>0.0%</b>		
<b>TOTAL CONSTRUCTION COST (2011 Dollars)</b>	<b>23,213,700</b>	<b>24,113,500</b>	<b>-899,800</b>	<b>-4%</b>	<b>23,574,500</b>	<b>-360,800</b>	<b>-2%</b>		

<b>Unit Cost Analysis</b>								
<b>Cost per sq.ft.:</b>	<b>225</b>	<b>234</b>	<b>-9</b>	<b>-4%</b>	<b>228</b>	<b>-3</b>	<b>-2%</b>	
<b>Cost per Unit:</b>	<b>203,629</b>	<b>211,522</b>	<b>-7,893</b>	<b>-4%</b>	<b>206,794</b>	<b>-3,165</b>	<b>-2%</b>	

**OPTION 3 COMPARISON**

**NUMBER OF UNITS:  
GROSS FLOOR AREA:**

**114 Unit  
103,200 sqft**

Element	Concrete (a)	Wood (Encap) (b)	Variance (a) - (b)		Wood (Charring) (c)	Variance (a) - (c)		Comments	
<b>A1 SUBSTRUCTURE</b>									
A11.1	Standard Foundations	928,800	516,000	412,800	44%	516,000	412,800	44%	Foundations to Timber Building will be lighter
A11.2	Special Foundations	0	0	0	0%	0	0	0%	
A12	Basement Excavation	1,857,600	1,857,600	0	0%	1,857,600	0	0%	
<b>A2 STRUCTURE</b>									
A21	Lowest Floor Construction	41,300	41,300	0	0%	41,300	0	0%	
A22.1	Upper Floor Construction	2,289,000	3,817,100	-1,528,100	-67%	3,877,000	-1,588,000	-69%	250mm thick timber panel floor
A22.2	Stair Construction	160,000	216,000	-56,000	-35%	216,000	-56,000	-35%	Timber Stairs construction with conc topping
A23	Roof Construction	103,200	161,500	-58,300	-56%	164,300	-61,100	-59%	169mm thick timber panel roof deck
<b>A3 EXTERIOR ENCLOSURE</b>									
A31	Structural Walls Below Grade	0	0	0	0%	0	0	0%	
A32.1	Walls Above Grade	497,900	497,900	0	0%	497,900	0	0%	
A32.2	Structural Walls Above Grade	0	0	0	0%	0	0	0%	
A32.3	Curtain Walls	1,839,500	1,839,500	0	0%	1,839,500	0	0%	
A33.1	Windows & Louvres	0	0	0	0%	0	0	0%	
A33.2	Glazed Screens	0	0	0	0%	0	0	0%	
A33.3	Doors	164,400	164,400	0	0%	164,400	0	0%	
A34.1	Roof Covering	46,400	46,400	0	0%	46,400	0	0%	
A34.2	Skylights	0	0	0	0%	0	0	0%	
A35	Projections	399,000	399,000	0	0%	399,000	0	0%	
<b>B1 PARTITIONS &amp; DOORS</b>									
B11.1	Fixed Partitions	1,117,200	1,296,500	-179,300	-16%	1,117,200	0	0%	Additional wallboard required for Fire-rating
B11.2	Moveable Partitions	0	0	0	0%	0	0	0%	
B11.3	Structural Partitions	2,604,200	2,409,400	194,800	7%	2,409,400	194,800	7%	Solid Timber Core walls in lieu of Concrete
B12	Doors	364,800	364,800	0	0%	364,800	0	0%	
<b>B2 FINISHES</b>									
B21	Floor Finishes	604,200	604,200	0	0%	604,200	0	0%	
B22	Ceiling Finishes	353,400	736,700	-383,300	-108%	353,400	0	0%	Additional wallboard required for Fire-rating
B23	Wall Finishes	478,800	478,800	0	0%	478,800	0	0%	
<b>B3 FITTINGS &amp; EQUIPMENT</b>									
B31.1	Metals	102,600	102,600	0	0%	102,600	0	0%	
B31.2	Millwork	627,000	627,000	0	0%	627,000	0	0%	
B31.3	Specialties	330,600	330,600	0	0%	330,600	0	0%	
B32	Equipment	798,000	798,000	0	0%	798,000	0	0%	
B33.1	Elevators	800,000	800,000	0	0%	800,000	0	0%	
B33.2	Escalators & Moving Walkways	0	0	0	0%	0	0	0%	
B33.3	Material Handling Systems	0	0	0	0%	0	0	0%	
<b>C1 MECHANICAL</b>									
C11	Plumbing and Drainage	1,151,400	1,151,400	0	0%	1,151,400	0	0%	
C12	Fire Protection	361,200	361,200	0	0%	361,200	0	0%	
C13	HVAC	855,000	855,000	0	0%	855,000	0	0%	
C14	Controls	34,200	34,200	0	0%	34,200	0	0%	
<b>C2 ELECTRICAL</b>									
C21	Service & Distribution	478,800	478,800	0	0%	478,800	0	0%	
C22	Lighting, Devices & Heating	820,800	820,800	0	0%	820,800	0	0%	
C23	Systems & Ancillaries	399,000	399,000	0	0%	399,000	0	0%	
<b>Z1 GENERAL REQUIREMENTS &amp; FEES</b>									
Z11	General Requirements	1,575,000	1,400,000	175,000	11%	1,400,000	175,000	11%	Timber Construction 2.5 months quicker approx
Z12	Fee	1,030,400	666,200	364,200	35%	651,200	379,200	37%	Less Management req'd due to off site detail design
<b>NET BUILDING COST</b>		<b>23,213,700</b>	<b>24,271,900</b>	<b>-1,058,200</b>	<b>-5%</b>	<b>23,757,000</b>	<b>-543,300</b>	<b>-2%</b>	
Harmonized Sales Tax					<b>0.0%</b>			<b>0.0%</b>	
<b>TOTAL CONSTRUCTION COST (2011 Dollars)</b>		<b>23,213,700</b>	<b>24,271,900</b>	<b>-1,058,200</b>	<b>-5%</b>	<b>23,757,000</b>	<b>-543,300</b>	<b>-2%</b>	

**Unit Cost Analysis**

Cost per sq.ft.:	225	235	-10	-5%	230	-5	-2%
Cost per Unit:	203,629	212,911	-9,282	-5%	208,395	-4,766	-2%

## Glossary

## Glossary

**Absorption** Absorption refers to a material's ability to absorb sound. Sound absorptive material can be installed in a cavity wall or floor to reduce sound transmission between spaces.

**AHJ** AHJ in this document is an acronym for the Authority Having Jurisdiction.

**Anthropogenic Climate Change** Anthropogenic Climate Change refers to the production of greenhouse gases emitted by anything related to human activity.

**Assembly Components** Assembly components refer to the individual members that determine the characteristics and qualities of an entire assembly (e.g. floor or wall assemblies). Typical components include gypsum board, sound absorption material, spacing of studs, resilient channels, finishing, topping, sub-floor, ceiling boards, and the size and spacing of joists.

**Building Envelope** The envelope of a building is designed to resist wind and earthquake loads, limit air leakage, control vapour diffusion, prevent rain penetration, prevent surface and cavity condensation, limit excessive heat loss and heat gain, and resist noise and fire.

**Carbon Sequestration** The ability of a material to store carbon.

**Charring Rate** Charring rate is the amount that a wood member will burn away when exposed to fire over time.

**Combustibility** A combustible material or assembly is considered to likely catch fire and burn.

**Condensation Control** To be resistant to condensation, a building enclosure system must incorporate various features such as thermal continuity and the ability to drain and dry.

**COV** COV in this document is an acronym for the City of Vancouver.

**Cross-Laminated Timber (CLT)** Cross-laminated timber consists of several layers of boards stacked crosswise (typically at 90 degrees) and fastened with glue, dowels or nails. CLT products are usually fabricated with three to seven layers.

**Curtain Wall** An airtight and weather resistant cladding and exterior wall system. This system is usually characterized by a grid of aluminum frames and large panels of glass as well as spandrel panels.

**Discontinuity** Discontinuity in a building assembly refers to a break or gap in the assembly that increases sound isolation to aid with sound transmission.

**Ductility** Ductility refers to a material's ability to mold, shape or bend without failing or breaking.

**FFTT** FFTT is a unique tilt-up system that effectively balloons frames mass timber panels in a cost effective and simple manner to build tall wood buildings.

**Fire Resistance Rating (FRR)** Fire resistance is a measure of a building assembly's ability to prevent the spread of heat and fire passing through a barrier as well as for a load bearing structure to continue to carry loads without collapsing or experiencing excessive deflection when exposed to fire.

**Fire Retardant and Resistant Coatings** Fire retardant and resistant coatings are products which can be applied to a surface of a material to aid in the delaying or stoppage of the combustion process.

**Flame Spread Rating (FSR)** Flame spread rating refers to the speed at which a flame will spread over the surface of an interior material.

**Flanking Sound** Flanking noise refers to when sound vibrations are transmitted through an assembly by moving across its top, bottom or sides and into an adjoining space.

**Glue-laminated Lumber** Glulam is a structural composite lumber where individual dimensional lumber is end jointed and glued together by a lamination process.

**Impact Insulation Class (IIC)** Impact sound is caused by a direct contact or impact on a floor or wall that vibrates the partition. This sound is then radiated in the cavity of the assembly which can then be transmitted into the adjacent space as sound.

**Laminated Strand Lumber (LSL)** Laminated strand lumber is a structural composite lumber manufactured from strands of wood species or species combinations blended with an adhesive. The strands are oriented parallel to the length of the member and then pressed into mats using a steam injection press.

**Laminated Veneer Lumber (LVL)** Laminated veneer lumber is made up of layers of wood veneers laminated together using an adhesive that are laid-up into a billet that is then fed into a hot press curing the adhesives under heat and pressure.

**Mass** The mass (weight or thickness) of a partition in a building assembly is one of the major factors in its ability to block sound.

**Mass timber Building System** Mass timber building systems in this document refer to any of three materials: Laminated Veneer Lumber (LVL), Laminated Strand Lumber (LSL), and Cross Laminated Timber (CLT).

**Moment Force** A moment force causes a tendency for rotation. This force is a product of a given force multiplied by its perpendicular distance from a determined point.

**Phenol Formaldehyde (PF)** PF is an adhesive used for structural composite lumber derived from crude oil; crystalline compound for phenol and methanol for formaldehyde.

**Phenol Resorcinol Formaldehyde (PRF)** PRF is an adhesive used for structural composite lumber with similar properties to PF but is more reactive (because of the resorcinol properties), meaning that curing is faster and takes place at room temperature.

**Polymeric Methylene Diphenyl Diisocyanate (pMDI)** pMDI is an isocyanate based adhesive typically used in combination with PF or PRF in the manufacture of structural composite lumber.

**Prefabricated** Prefabricated construction refers to shop manufactured components that are transported to a site and assembled on location.

**Rain Penetration Control** There are two approaches to rain penetration control; face sealed systems and rain screen systems. The principles of a rain screen include the control of capillary action, surface and cavity drainage, pressure equalization, compartmentalization, use of backpans, and ventilated spandrel cavities to allow a path for any water entering the system to exit and for assembly components to dry.

**Resilient Connections** Resilient channels are typically fastened to structural members of an assembly that are used to break the sound transmission path.

**Seismic Force** Seismic forces are associated with earthquakes and tremors.

**Shear Force** A shear force acts parallel to a plane of a component or material.

**Smoke Developed Classification** Smoke developed classification (SDC) is rated in a similar way as flame spread rating, where the numerical classification indicates the smoke generation rate of a certain material.

**Sound Transmission Class (STC)** Sound transmission can be defined as sound waves hitting one side of a partition causing the face of the partition to vibrate which radiates as sound on the other side of the partition.

**Structural Composite Lumber** Structural composite lumber in this document refers to either Laminated Veneer Lumber (LVL), Laminated Strand Lumber (LSL), or Cross-laminated Timber (CLT).

**Sustainability Indicators** Sustainable forest management is monitored by applying a set of indicators, which are objective measures that can be supported by data and by certification systems.

**Tilt-Up Construction** Tilt-up construction refers to a method of construction where panels of a structure are either pre-fabricated or assembled on site and then 'tilted' into place by means of large cranes and attached to footings, roof structures and to each other.

**TWB** TWB in this document is an acronym for a Tall Wood Building (a structure using mass timber).

**Urea-Formaldehyde (UF)** Urea-formaldehyde is a thick, creamy adhesive that dries to a colorless solid. UF is commonly associated with most wood products but is only suitable for interior applications and not for damp conditions. The raw materials for UF adhesives are derived from natural gas; ammonia for urea and methanol for formaldehyde.





## **Bibliography**

## Bibliography

- American Wood Council. "Fire Performances of Wood Products Awareness Guide." Wood Aware. August 2006. <http://www.woodaware.info/PDFs/FirePerformance.pdf> (accessed 02 25, 2011).
- APA The Engineered Wood Association. LP SolidStart Laminated Strand Lumber and Laminated Veneer Lumber, Louisiana-Pacific Corporation. Product Report, Tacoma: APA, 2010.
- APA-The Engineered Wood Association. "Fire-Rated Systems." Design/Construction Guide, 2005: 1-27.
- Binderholz. "Tiptop Timber." Cross Laminated Timber BBS. 2009. <http://www.binderholz.com> (accessed February 7, 2010).
- British Columbia Building Code. 3.2.2.42. Group C, Any Height, Any Area, Sprinklered. Building Code, BCBC, 2006.
- Canadian Council of Forest Ministers. "Sustainable Forest Management in Canada." Reports and Papers. [http://www.ccfm.org/english/reports\\_articles.asp](http://www.ccfm.org/english/reports_articles.asp) (accessed 03 23, 2011).
- Canadian Mortgage and Housing Corporation. "Floor assembly details." Multi-Family Wood Frame Buildings. 2009. [http://www.cmhc-schl.gc.ca/en/inpr/bude/himu/codemo/images/detail10b\\_2.jpg](http://www.cmhc-schl.gc.ca/en/inpr/bude/himu/codemo/images/detail10b_2.jpg) (accessed February 02, 2011).
- . "The Rain Screen Wall System." Building Envelope. 2002. <http://www.cmhc-schl.gc.ca/en/inpr/bude/himu/coedar/upload/The-Rain-Screen-Wall-System.pdf> (accessed 03 28, 2011).
- Canadian Wood Council. "Adhesives." Canadian Wood Council-Products. <http://www.cwc.ca/products/connections> (accessed 02 16, 2011).
- . "Embodied Energy of WOOD Products." Quick Facts - Sustainable Building Series. 2004. [http://www.cwc.ca/NR/rdonlyres/FD8693D4-C735-44CA-959C-178D43FE092A/0/Quickfacts\\_Sustainable\\_Building\\_Series\\_05.pdf](http://www.cwc.ca/NR/rdonlyres/FD8693D4-C735-44CA-959C-178D43FE092A/0/Quickfacts_Sustainable_Building_Series_05.pdf) (accessed March 12, 2011).
- . "Engineered Wood Products (EWP)." Products and Connections. 2010. <http://www.cwc.ca/products/connections> (accessed February 16, 2011).
- . "Fire Safety Defined." Design with Wood/Fire Safety. 2010. <http://www.cwc.ca/designwithwood/firesafety> (accessed February 16th, 2011).
- Council of Forest Industries. COFI. January 11, 2011. <http://www.cofi.org> (accessed 03 14, 2011).
- Crespell, Pablo, and Sylvain Gagnon. "Cross Laminated Timber." A Primer, 2010: 1-24.
- CST Innovations. CST Innovations: The Innovation of the CLT Panel. Research, New Westminster: CANFOR Research and Development Centre.
- Department of Housing and Urban Development. TimberStrand LSL. Materials Release, Washington: HUD, 2007.
- . "Weyerhaeuser." Materials Release: Microllam Laminated Veneer Lumber. October 29, 2010. <http://www.weyerhaeuser.com> (accessed February 15, 2011).
- Detail . Murray Grove. 2009. [http://www.detail360.com/project/murray-grove-pjid\\_1501.htm](http://www.detail360.com/project/murray-grove-pjid_1501.htm) (accessed 01 19, 2011).
- Emery, John A. "Structural Wood Panels and Formaldehyde." APA The Engineered Wood Association, 2002: 1-3.
- Environment Canada. "Greenhouse Gas Sources and Sinks in Canada." National Inventory Report. 2005. [http://www.ec.gc.ca/pdb/ghg/inventory\\_report/2005\\_report/toc\\_e.cfm](http://www.ec.gc.ca/pdb/ghg/inventory_report/2005_report/toc_e.cfm) (accessed 03 21, 2011).
- FAO Advisory Committee on Paper and Wood products. "FAO Forestry." FAO of the United Nations. May 2003. <http://www.fao.org/docrep/006/Y4829E/y4829e25.html> (accessed March 16, 2010).
- Fire and Structural Engineering Quick Solutions for Timber. 09 21, 2009. <http://www.mace.manchester.ac.uk/project/research/structures/strucfire/Quick%20Solutions/timber/lighttimber.html> (accessed 03 17, 2011).
- Forest Innovation Investment. "British Columbia Tree Species." Canada Wood. 2010. <http://www.bcforestproducts.com> (accessed March 13, 2011).

- . Naturally: Wood. 2010. <http://www.naturallywood.com/Wood-Products/Wood-Species/Overview.aspx> (accessed 03 14, 2011).
- Forestry Innovation Investment. "British Columbia Tree Species." Naturally: Wood. 2010. [http://www.naturallywood.com/uploadedFiles/General/Wood\\_Products/43-1512\\_species%20sheets\\_final.pdf](http://www.naturallywood.com/uploadedFiles/General/Wood_Products/43-1512_species%20sheets_final.pdf) (accessed 03 14, 2011).
- FPIInnovations. CLT handbook: cross-laminated timber. Edited by Sylvain Gagnon and Ciprian Pirvu. Quebec City: Library and Archives Canada Cataloguing in Publication, 2011.
- GHL Consultants Ltd. Technical and Process Risks in 5 and 6 Storey Wood-Frame Buildings of Residential Occupancy. Technical, Victoria: Ministry of Housing and Social Development, 2009.
- Government of British Columbia. A Guide to the BC Economy and Labour Market. 2011. [http://www.guidetobceconomy.org/major\\_industries/forestry.htm](http://www.guidetobceconomy.org/major_industries/forestry.htm) (accessed March 14, 2011).
- ICC-ES Evaluation Service. ICC-ES Evaluation Report . Evaluation Report, Wood, Plastics and Composites, International Code Council Evaluation Report, 2011.
- Intergovernmental Panel on Climate Change. Climate Change 2007: The Physical Science Basis. New York: Cambridge University Press, 2007.
- International Code Council Evaluation Service. ICC\_ES SAVE: Verification of Attributes Report. Verification of Attributes, Wood, Plastics and Composites, ICC ES, 2010.
- Klebstoffe. EPI Adhesives. TKH-Technical Information Sheet, Dusseldorf: Technical Committee on Wood Adhesives, 2007.
- KLH. 2003. <http://www.klh.at> (accessed January 17, 2010).
- Louisiana-Pacific Corporation. LP SolidStart LSL Material Safety Data Sheet. MSDS, Nashville: LP Corp., 2010.
- . "LP SolidStart LVL Technical Guide." LP Engineered Wood Products. 2010. <http://www.lpcorp.com> (accessed February 22, 2011).
- . "LP SolidStart LVL U.S. Technical Guide." LP CORP. 12 18, 2010. <http://lpcorp.com> (accessed February 5, 2011).
- Meinhold, Bridgette. InHabitat. 08 24, 2009. <http://inhabitat.com/worlds-tallest-wooden-building-planned-for-norway/> (accessed 01 23, 2011).
- Michler, Andrew. InHabitat. 11 01, 2010. <http://inhabitat.com/lifecycle-tower-in-austria-will-be-worlds-tallest-wooden-building/2/> (accessed 01 17, 2011).
- Ministry of Municipal Affairs and Housing. Ruling of the Minister of Municipal Affairs and Housing: 05-20-144 (08675-R). Ontario, April 9, 2010.
- National Building Code of Canada. Table A-9.1 0.3.1 .A 1995 National Building Code of Canada. Table, NBC, 1995.
- National Forestry Database. "Wood Supply Quick Facts." NFD. February 18, 2011. [http://nfdp.ccfm.org/supply/quick\\_facts\\_e.php](http://nfdp.ccfm.org/supply/quick_facts_e.php) (accessed 03 14, 2011).
- National Research Council Canada. CCMC Nordic Lam. Evaluation, CCMC, 2007.
- National Research Council of Canada. "Fire Resistance and Sound Transmission." Canadian Mortgage and Housing Corporation . 2009. <http://www.cmhc-schl.gc.ca/publications/en/rh-pr/tech/images/00-109d.jpg> (accessed February 16, 2011).
- Natural Resources Canada. "Canada's Forests." Natural Resources Canada. 09 11, 2010 . <http://canadaforests.nrcan.gc.ca/?lang=en> (accessed 03 23, 2011).
- . "Canadian Forest Service Science-Policy Notes." Natural Resources Canada. October 2007. <http://www.nrcan.gov.ca> (accessed 03 22, 2011).
- . "Key facts." Canada's Forests. 09 11, 2010. <http://canadaforests.nrcan.gc.ca/?lang=en> (accessed 03 23, 2011).
- naturally:wood. "Mountain Pine Beetle." British Columbia Forest Facts. September 2010. <http://www.naturallywood.com> (accessed March 14, 2011).
- naturally:wood. "Wood Product Supplier Directory." naturally: wood. 2010. <http://naturallywood.com/productdirectory/default> (accessed March 03, 2011).

- NRC-CNRC Institute for Research in Construction. LP SolidStart Laminated Strand Lumber. Evaluation Report CCMC 13319-R, Ottawa: NRC CNRC, 2008.
- NRC-CNRC Institute for Research in Construction. LP SolidStart LVL. Evaluation, NRC-CNRC, 2008.
- NRC-CNRC Institute for Research in Construction. Microllam LVL CCMC 08675-R. Evaluation Report, Ottawa: NRC-CNRC, 2010.
- NRC-CNRC Institute for Research in Construction. TimberStrand LSL. Evaluation Report, Ottawa: NRC-CNRC, 2009.
- NRC-CNRC Institute for Research in Construction. Wood Adhesives. Evaluation, NRC-CNRC, 2009.
- NZ Wood. "Fire Resistance." NZ Wood: For a Better World. 2007. <http://www.nzwood.co.nz/why-wood/fire/fire-resistance/> (accessed 03 18, 2011).
- PriceWaterHouseCoopers. "Report on the Economic Impact of the BC Pulp and Paper Industry Task Force." Pulp & Paper BC. November 2007. <http://www.pulpandpaperbc.ca/publications.html> (accessed March 14, 2011).
- Regupol America Inc. Acoustic Rubber Underlayment. Specifications, Agawam, MA: Impacta-Regupol, 2010.
- Rhomberg. CREE. 2010. <http://www.creebyrhomborg.com> (accessed January 23, 2011).
- Roberts Company. Acoustic Underlayment. Specification, Boca Raton: Roberts Company Canada LTD., 2010.
- Ruling of the Minister of Municipal Affairs and Housing. Ministers Ruling: Manufacturer, Weyerhaeuser TimberStrand LSL. Terms and Conditions, Toronto: Ruling of the Minister, 2010.
- Saint-Gobain Insulation. ISOVER. Specifications, Cedex France: Saint-Gobain Insulation, 2010.
- Schaffer, E.L. Structural Fire Design:Wood. Research Paper FPL 450, Forest Products Laboratory, United States Department of Agriculture, 1984.
- Smith, Prof. Ian, and Dr.. Andrea Frangi. "Structural Engineering International." Journal of the International Association for Bridge and Structural Engineering, 2008: 1-100.
- Statistics Canada. British Columbia Lumber Production by Species 2005. Production Catalogue, Statistics Canada Catalogue, 2005.
- Statistics Canada Catalogue. British Columbia Lumber Production by Species. Production Statistics, Statistics Canada, 2005.
- The Formaldehyde Council. "What is Formaldehyde?" Formaldehyde. October 2007. <http://www.formaldehyde.org> (accessed March 15, 2011).
- U.S. Department of Housing and Urban Development. Materials Release: LP SolidStart LVL and LP SolidStart OSL. Atlanta: HUD MR, 2007.
- U.S. Energy Information Administration. "Annual Energy Review 2009." Independent Statistics and Analysis E.I.A. August 19, 2010. <http://www.eia.doe.gov/totalenergy/data/annual/pdf/aer.pdf> (accessed November 18, 2010).
- Underwriters Laboratories of Canada. Blazeguard: Laminated Panel. Procedure and Report on Material, ULC, 2010.
- UN-HABITAT. State of the World's Cities 2010/2011: Bridging the Urban Divide. Nairobi: United Nations Human Settlements Programme, 2008.
- Urban Arts Architecture. "Canadian Wood Council." Expanding Market Demand for Canadian Wood Products. March 8, 2008. <http://www.cwc.ca/NR/rdonlyres/5A044E73-C28D-486D-8625-42C98548C039/0/MidRisereportbyUrbanArtsI.pdf> (accessed April 24, 2011).
- USDA, Forest Service. "Flame Spread Index for Wood Products." Fire Safety of Wood Products. 2010. [http://www.terramai.com/userfiles/file/Technical/USDA\\_Flame\\_Spread\\_Index\\_for\\_Wood.pdf](http://www.terramai.com/userfiles/file/Technical/USDA_Flame_Spread_Index_for_Wood.pdf) (accessed 03 9, 2011).
- Vacca, Phil. LP SolidStart Engineered Wood Products and Formaldehyde Emissions. Adhesive Product Report, APA and LP Corporation, 2009.
- Waugh, Andrew, Karl Heinz Weiss, and Mathew Wells. A Process Revealed. London: Murray & Sorrell FUEL Design & Publishing, 2009.
- West Fraser LVL. LVL User's Guide. Technical Data, Rocky Mountain House: West Fraser, 2009.

- Weyerhaeuser Company. "#TJ-9000 Specifier's Guide." iLevel. December 2010. <http://www.iLevel.com> (accessed February 18, 2011).
- . "#TJ-9005 Specifier's Guide." iLevel. February 2009. <http://www.ilevel.com> (accessed January 26, 2011).
- . "Material Safety Data Sheet." Weyerhaeuser LVL or LSL. September 21, 2010. <http://weyerhaeuser.com/Sustainability/MSDS> (accessed February 14, 2011).
- Weyerhaeuser. "Fire Facts Guide #1500." iLevel. July 2008. <http://www.ilevel.com> (accessed February 23rd, 2011).
- Weyerhaeuser Material Safety Data Sheet WC 414-02 (M). MSDS, Federal Way: Weyerhaeuser, 2010.
- Weyerhaeuser. "Residential Wall Guide." iLevel. July 2010. <http://www.ilevel.com> (accessed January 31, 2011).
- White, Robert H. Fire Resistance of Structural Composite Lumber Products. Research Paper FPL-RP-633, Madison, WI: United States Department of Agriculture, Forest Service, Forest Products Laboratory, 2006.
- Xella. FERMACELL Dry Flooring Elements. Specifications, Sutton Coldfield: Xella Group, 2007.

**CONTACT:**

MGA | MICHAEL GREEN ARCHITECTURE  
63 E CORDOVA ST VANCOUVER, BC V6A 1K3  
+1 (604) 336-4770

**ORIGINALLY PREPARED BY:**

Michael Green at McFarlane Green Biggar  
Equilibrium Consulting  
LMDG Ltd  
BTY Group

**UPDATED BY:**

MICHAEL GREEN ARCHITECTURE INC.

Funding for this 'Case Study' project was provided to the Canadian Wood Council (CWC) on behalf of the Wood Enterprise Coalition (WEC) by Forestry Innovation Investment (FII). Any results, findings, conclusions or recommendations are those of the author, and do not necessarily represent those of the CWC, WEC-it's partners, FII or the Province of British Columbia.

